

www.surgintr.com



Surgintr[®]

MANUFACTURERS & EXPORTERS OF QUALITY SURGICAL INSTRUMENTS



Table Of Contents

















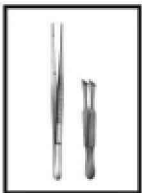
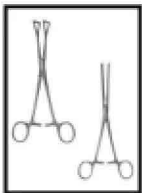
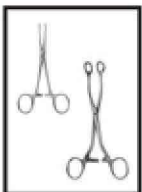
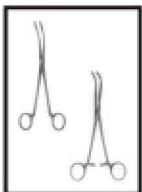

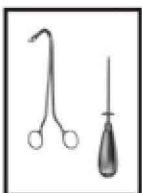
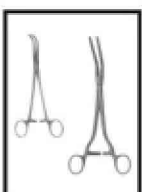
Diagnostic, Anaesthesia and other instruments	Page Seite 1 - 10		Probes, Pocket Instruments sets	Page Seite 66 - 68	
Scalpels, knives and Scalpel Handles	11 - 14		Wound Retractors	69 - 80	
Scissors	15 - 31		Self-Retaining Retractors, Abdominal Retractors	81 - 85	
Dissecting-and Tissue Forceps	32 - 42		Abdominal Surgery Intestinal-and Rectal Instruments	86 - 93	
Sponge, Dressing and Tissue Grasping Forceps Towel Clamps	43 - 48		Gall Bladder-, Liver-and Spleen Instruments	94 - 96	
Vessel Clips, Bulldog Clamps Haemostatic Forceps	49 - 57		Genito-Urinary Instruments and Trocars	97 - 100	
Ligature, Hysterectomy and Compression Forceps Vaginal Clamps	58 - 60		Vaginal Specula and Uterine Dilators	101 - 106	
Needle Holders, Suture Instruments	61 - 65		Uterine Probes, Uterine Dressing-, Polypus-and Ovum Forceps	107 - 109	

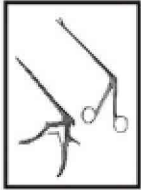

Table Of Contents

	Page Seite		Seite
Biopsy Instruments and Curettes	110 - 116		Suction Instruments 158 - 166
Obstetrics and Tracheotomy	117 - 119		
Cardiovascular-and Thoracic Surgery	120 - 128		
Bone Punches, Rongeurs	129 - 134		
Elevators, Bone Levers, Raspatories, Bone Files, Bone Curettes	135 - 139		
Mallets, Chisels and Gouges	140 - 141		
Bone Holding Forceps, Bone Rongeurs, Bone Cutting Forceps	142 - 146		
Plaster Instruments	147 - 157		



Percussion Hammers and Aesthesiometers



01-101
TROEMNER
Size: 245 mm



01-102
DEJERINE
Size: 200 mm



01-103
DEJERINE
with needle
Size: 210 mm



01-104
TAYLOR
Size: 195 mm



01-105
BERLINER
Size: 200 mm



01-106
BUCK
with needle
and brush
Size: 180 mm



01-107
RABINER
with needle
and brush
Size: 255 mm



01-108
ALY
Size: 190 mm



01-109
WARTENBERG
Pinwheel for
neurological
examination
Size: 185 mm

Stethoscopes



01-110
PINARD (Aluminum)
Size: 155 mm

1/2



01-111
wooden
Size: 145 mm

1/2



01-112
BOWLES
Stethoscope
with diaphragm

1/4



01-113
ANESTOPHON

1/3



01-114
FORD-BOWLES
Dual chest piece
with two outlets

1/4



01-115
BOWLES

1/4

Head Mirrors and Head Bands

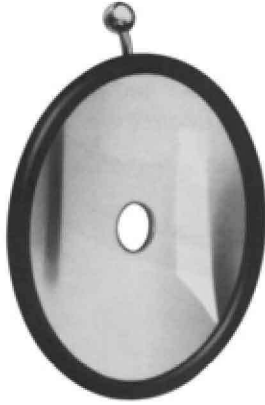

01-116
ZIEGLER Ø 90mm
head mirror only
with rubber coating

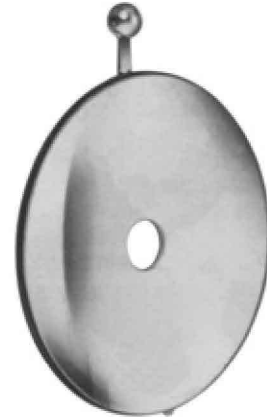

01-117
ZIEGLER Ø 90mm
head mirror only
with metal coating



01-118
ZIEGLER
head band of plastic black

01-119
ZIEGLER
head band of plastic white



01-120
MURPHY
head band of celluloid, white

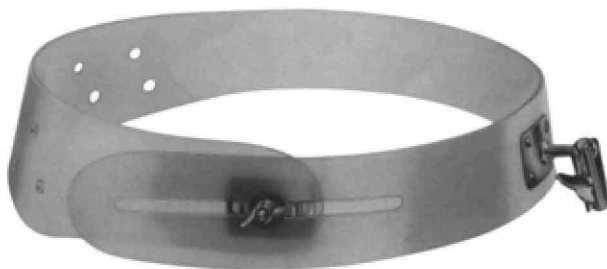

01-121
head band of plastic,
white, soft pattern



01-122
head mirror with black
plastic head band.

Tongue Depressors

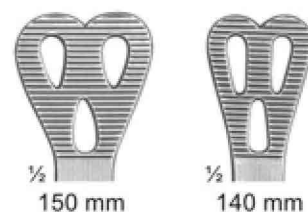
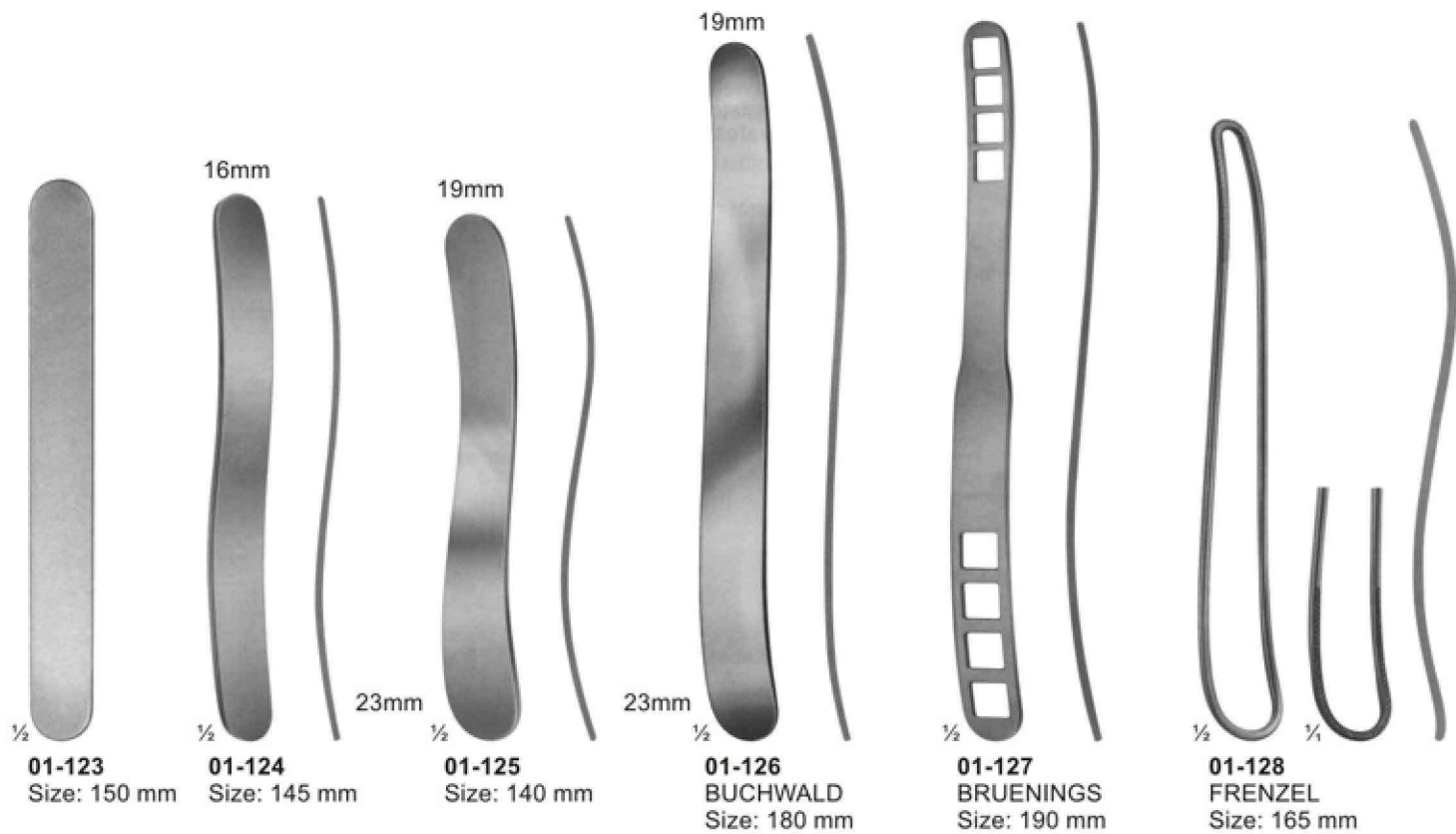

Instruments for Anaesthesia and Tongue Forceps



01-134
SCHIMMELBUSCH
Ether mask



01-135
HEISTER
Mouth gag
Size: 130 mm



01-136
FERGUSSON-ACKLAND
Mouth gag
Size: 145 mm



01-137
DENHARDT
Mouth gag with silicon
inserts, interchangeable
Size: 125 mm



01-138
ROSER KOENIG
Mouth gag
Size: 160 mm, 185 mm



01-139
YOUNG
Size: 165 mm



1 Pair Of
Rubber Pads

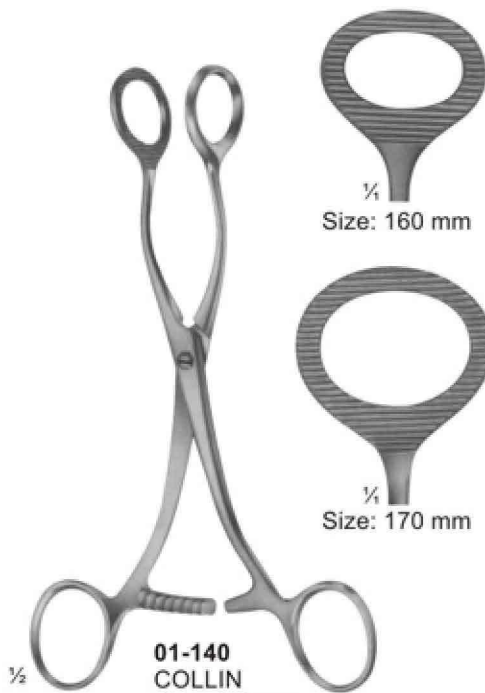

01-140
COLLIN
Size: 160 mm,
170 mm

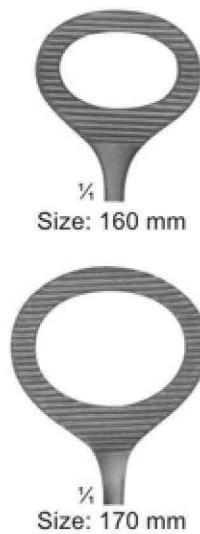

Size: 160 mm

Size: 170 mm

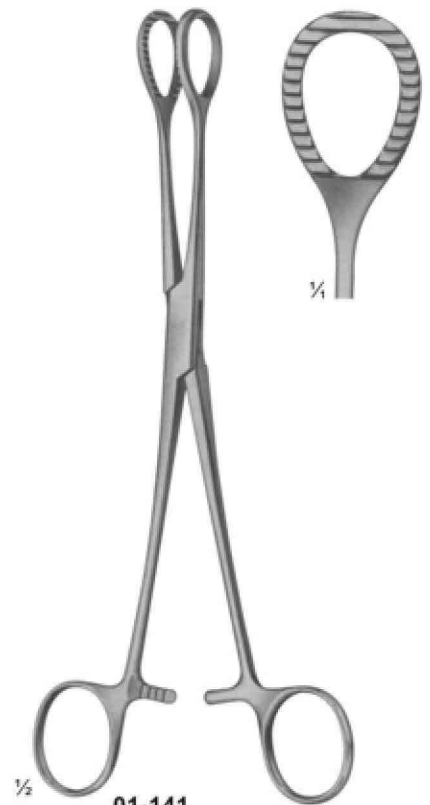

01-141
HEYWOOD-SMITH
modif. Size: 215 mm

Blood Lancets and Laryngeal Mirrors

01-142
FRANCKE
Automatic blood lancet

01-143
Laryngeal mirrors with hexagonal handle
Size: 180 mm

01-144
KOLLE
Microscopic Needle Holder with plastic handle.
Size: 240 mm

01-145
Mirror handle
Size: 110 mm

01-146
Mirror handle
Size: 105 mm

01-147
MICHEL
Rhinoscopic mirrors with interchangeable mirror inserts
Size: 250 mm

01-148
Spare mirrors only
Size: 12 mm

01-149
Spare mirrors only
Size: 14 mm

Fig. 000 \varnothing 6mm

Fig. 00 \varnothing 8mm

Fig. 0 \varnothing 10mm

Fig. 1 \varnothing 12mm

Fig. 2 \varnothing 14mm

Fig. 3 \varnothing 16mm

Fig. 4 \varnothing 18mm

Fig. 5 \varnothing 20mm

Fig. 6 \varnothing 22mm

Fig. 7 \varnothing 24mm

Fig. 8 \varnothing 26mm

Fig. 9 \varnothing 28mm

Fig. 10 \varnothing 30mm

Laryngoscope and Diagnostic Sets

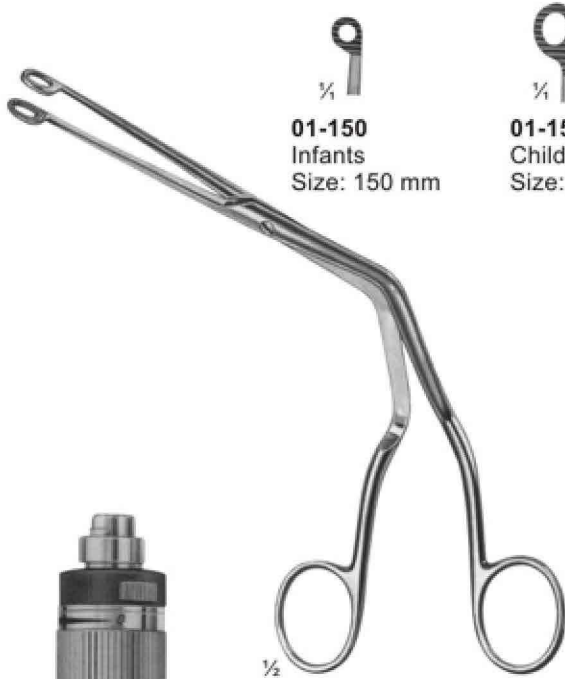

01-150
Infants
Size: 150 mm



01-151
Children
Size: 200 mm



01-152
Adults
Size: 250 mm

1/2

01-150 - 152
MAGILL



01-153
Medium battery handle
only, 25 mm diam.



01-153-A
Spare bulb
2.7 volt, for
otoscopes



01-153-B
Spare bulb
2.6 volt, for
ophthalmoscopes

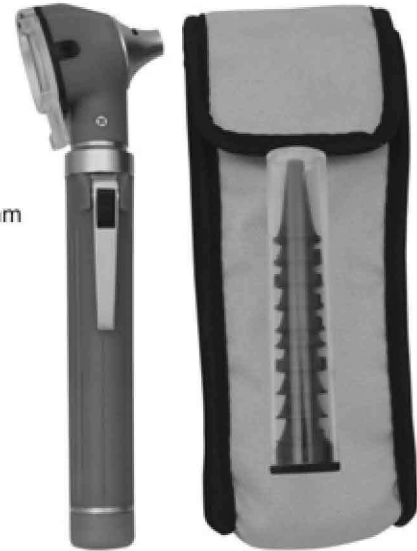

01-154



01-155



01-156
Otoscope set, consists of
battery handle without batteries,
3 ear specula, 1 bulb in valvet lined case



01-157
Diagnostic set, otoscope with three specula,
nasal speculam, lamp holder, two laryngeal
mirrors, tongue blade holder

Laryngoscopes



01-158
MILLER
 Laryngoscope set, consists of battery handle (without battery)
 with four miller laryngoscope blades

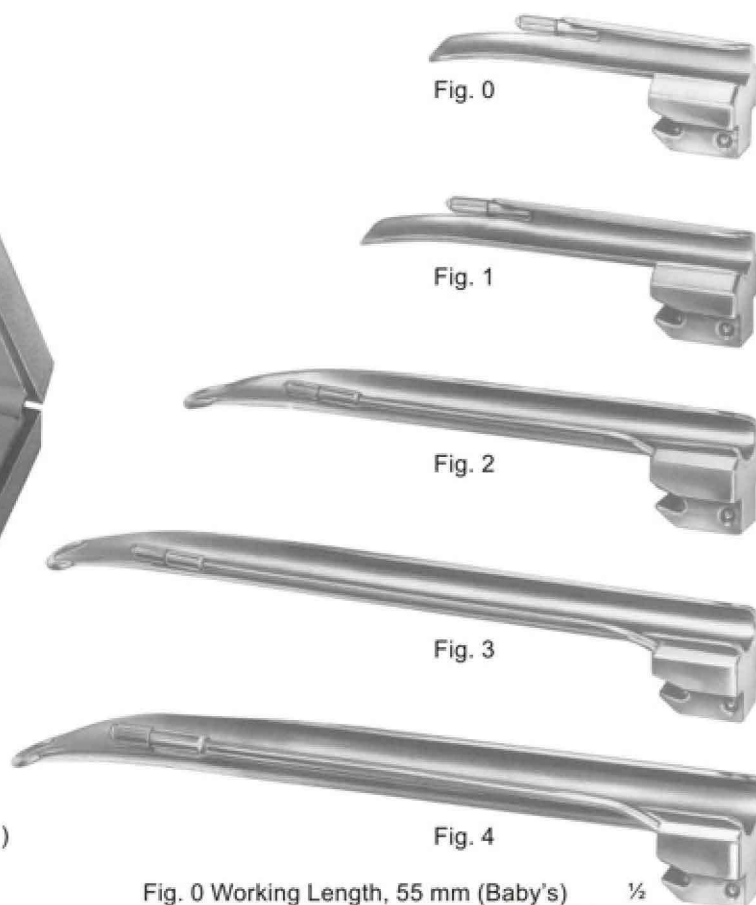

Fig. 0 Working Length, 55 mm (Baby's) 1/2
 Fig. 1 Working Length, 80 mm (Children's)
 Fig. 2 Working Length, 130 mm (Adolescent's)
 Fig. 3 Working Length, 170 mm (Women's)
 Fig. 4 Working Length, 180 mm (Men's)



01-159
GUEDEL-NEGUS
 Laryngoscope set, consists of battery handle (without battery)
 with four miller laryngoscope blades



Fig. 1 Working Length, 70 mm (Children's)
 Fig. 2 Working Length, 90 mm (Adolescent's)
 Fig. 3 Working Length, 110 mm (Women's)
 Fig. 4 Working Length, 135 mm (Men's)

Laryngoscopes



1/3

01-160
McINTOSH
Laryngoscope Set, Consists Of Battery Handle (Without Battery)
With Three McIntosh Blades, Fig. 1, Fig. 2, Fig. 3

01-161
McINTOSH
Laryngoscope Set, Consists Of Battery Handle (Without Battery)
With Five McIntosh Blades, Fig. 0, Fig. 1, Fig. 2, Fig. 3, Fig. 4

Fig. 0

Fig. 1

Fig. 2

Fig. 3

Fig. 4

1/2

01-161 A Fig. 0 Working Length, 55 mm (Baby's)
01-161 B Fig. 1 Working Length, 75 mm (Children's)
01-161 C Fig. 2 Working Length, 90 mm (Adolescent's)
01-161 D Fig. 3 Working Length, 110 mm (Women's)
01-161 E Fig. 4 Working Length, 135 mm (Men's)



1/3

01-162
FOREGGER
Laryngoscope Set, Consists Of
Battery Handle (Without Battery)
With Three Foregger Blades,
Fig. 1, Fig. 2, Fig. 3,

01-163
FOREGGER
Laryngoscope Set, Consists Of
Battery Handle (Without Battery)
With Four Foregger Blades,
Fig. 1, Fig. 2, Fig. 3, Fig. 4,

Fig. 1

Fig. 2

Fig. 3

Fig. 4

1/2

01-162 A Fig. 1 Working Length, 70 mm (Children's)
01-162 B Fig. 2 Working Length, 90 mm (Adolescent's)
01-162 C Fig. 3 Working Length, 110 mm (Women's)
01-162 D Fig. 4 Working Length, 135 mm (Men's)



1/3

01-164
Fiber Optic
Battery Handle
30mm diam.



1/3

01-165
Fiber Optic
Battery Handle
18mm diam.



1/3

01-166
Replacement Lamp
(Krypton) 2.5 V



1/3

01-167
Replacement Lamp
(Halogen) 2.5 V

Examination & Measuring Instruments

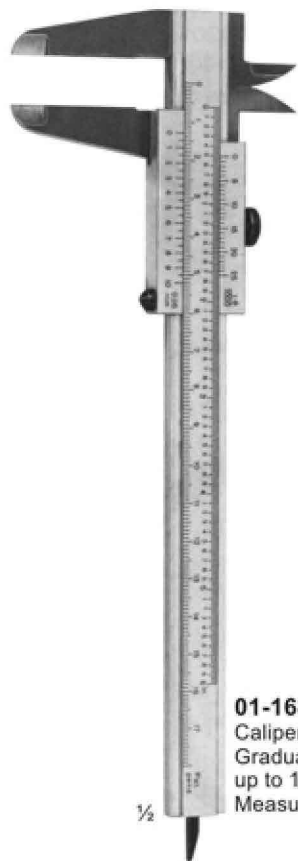

01-168
Caliper Of Aluminium
Graduated in mm & inches
up to 180mm
Measuring Range up to 139mm



01-169
VERNIER
Universal Caliper Of Steel
Graduated in mm & inches
up to 180mm
Measuring Range up to 120mm
with Vernier in 1/10mm & 1/16"

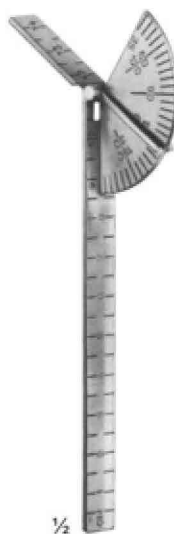

01-170
CARROLL
Size: 145 mm
Finger Goniometer



01-171
TOWNLEY
Graduated in
mm & inches
Size: 115 mm



01-172
COLLIN
Druck Pressure 72 kg
Size: 125 mm



01-173
BERTILLON
Caliper For Measuring The Head
Size: 320 mm



01-174
CASTROVIEJO
Caliper
Size: 75mm



01-175
MOLTGEN
Goniometer



01-176
Size: 150 mm



01-177
Size: 500 mm



Dissecting Knives



1/2
02-101 - 110
Fig. 1 - 10



02-101
Fig. 1
30 mm



02-102
Fig. 2
36 mm



02-103
Fig. 3
40 mm



02-104
Fig. 4
45 mm



02-105
Fig. 5
50 mm



02-106
Fig. 6
27 mm



02-107
Fig. 7
35 mm



02-108
Fig. 8
40 mm



02-109
Fig. 9
47 mm



02-110
Fig. 10
50 mm

**Amputating Knives, Cartilage Knives
and Autopsy Knives**



LISTON
02-111
Size: 130 mm
02-112
Size: 160 mm
02-113
Size: 190 mm
02-114
Size: 200 mm

02-115
CATLIN
Size: 160 mm
Blade length
Amputating
Knives

02-116
LANGENBECK
Size: 120 mm
Blade length
Flap Knives

02-117
Size: 110 mm
Blade length
Interosseous
Knives

02-118
Size: 55 mm
Blade length
with raspatory,
Wooden handle

02-119
Size: 70 mm
Blade length
Wooden handle

02-120
Size: 80 mm
Blade length
Metal handle

02-121
Size: 195 mm
Blade length
Metal handle

Blade length
Amputating Knives

Cone Knives, Myomatome, Trigeminal and Tonsil Knives



02-122
AYRE
Size: 235 mm
Cone Knife

02-123
Size: 230 mm
Cone Knife

02-124
SEGOND
Size: 270 mm
Myomatome

02-125
OLIVECRONA
Size: 205 mm
Trigeminal
Knife

02-126
Size: 230 mm
Trigeminal
Knife

02-127
FOWLER
Size: 200 mm
Tonsil Knife

02-128
ABRAHAM
Size: 215 mm
Tonsil Knife

02-129
BRUNINGS
Size: 215 mm
Tonsil Knife

Scalpel Handles

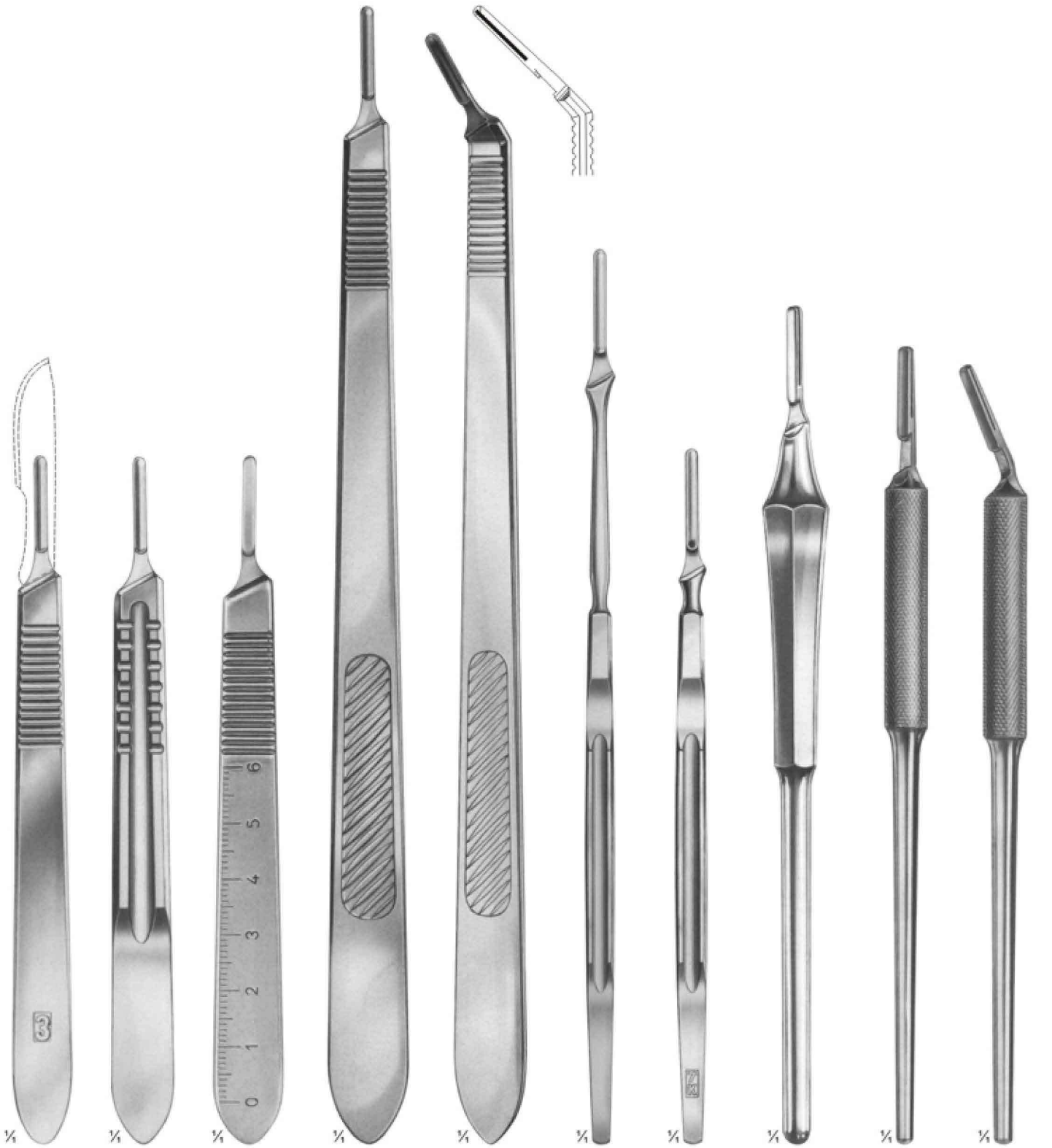

02-130 STANDARD No. 3 Solid 12 cm	02-131 No. 3 Solid 12 cm	02-132 No. 3 Solid 12 cm	02-133 No. 3 L Straight Solid 21.5 cm	02-134 No. 3 L Angled Solid 21 cm	02-135 No. 7 Solid 16 cm	02-136 No. 7 K Solid 12.5 cm	02-137 Hollow-Round 15.5 cm	02-138 No. 3 Straight Solid, Round 14.5 cm	02-139 No. 3 Angled Solid, Round 14 cm
--	--	--	--	--	--	--	--	--	--

Micro Scissors (Spring Type) with Flat Handles

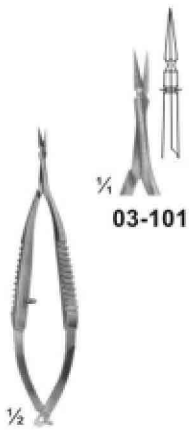

03-101

03-102

03-103

03-101 - 103
VANNAS
Size: 85 mm



03-104 - 105
CASTROVIEJO
Size: 95 mm



03-105

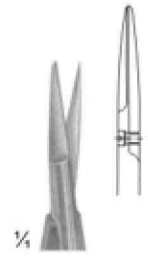

03-106
NOYES
Size: 125 mm

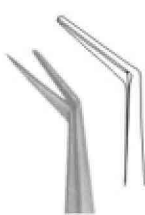

03-107

03-108

03-107 - 108
WECKER
Eye scissor
Size: 110 mm

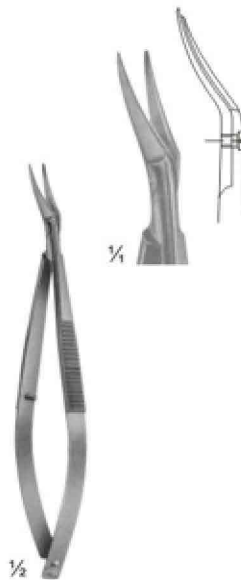

03-109
CASTROVIEJO
Eye scissor
Size: 115 mm

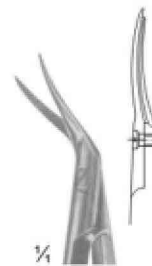

03-110

03-111

03-110 - 111
CASTROVIEJO
Eye scissor
Size: 110 mm

Micro Scissors (Spring Type) with Flat Handles

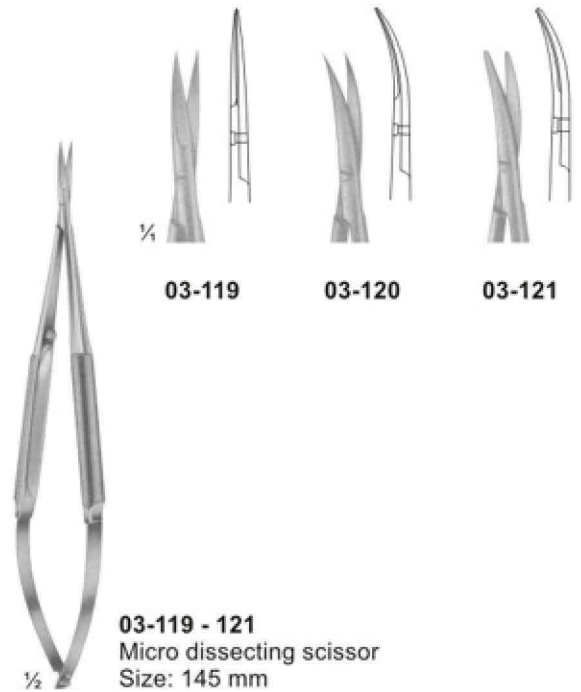
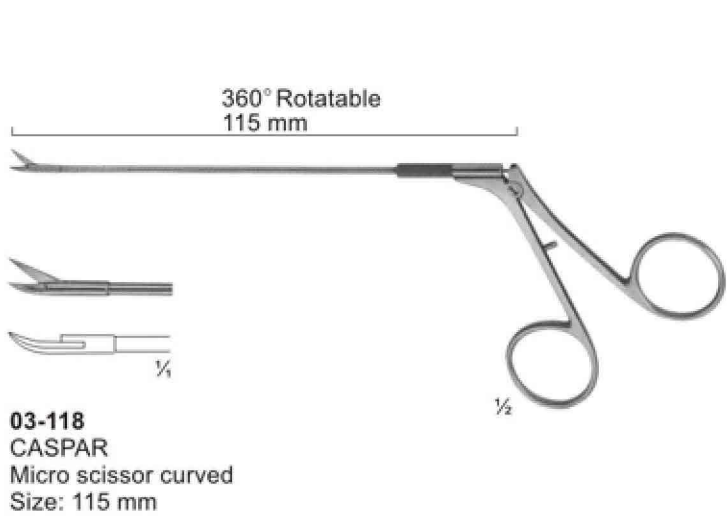
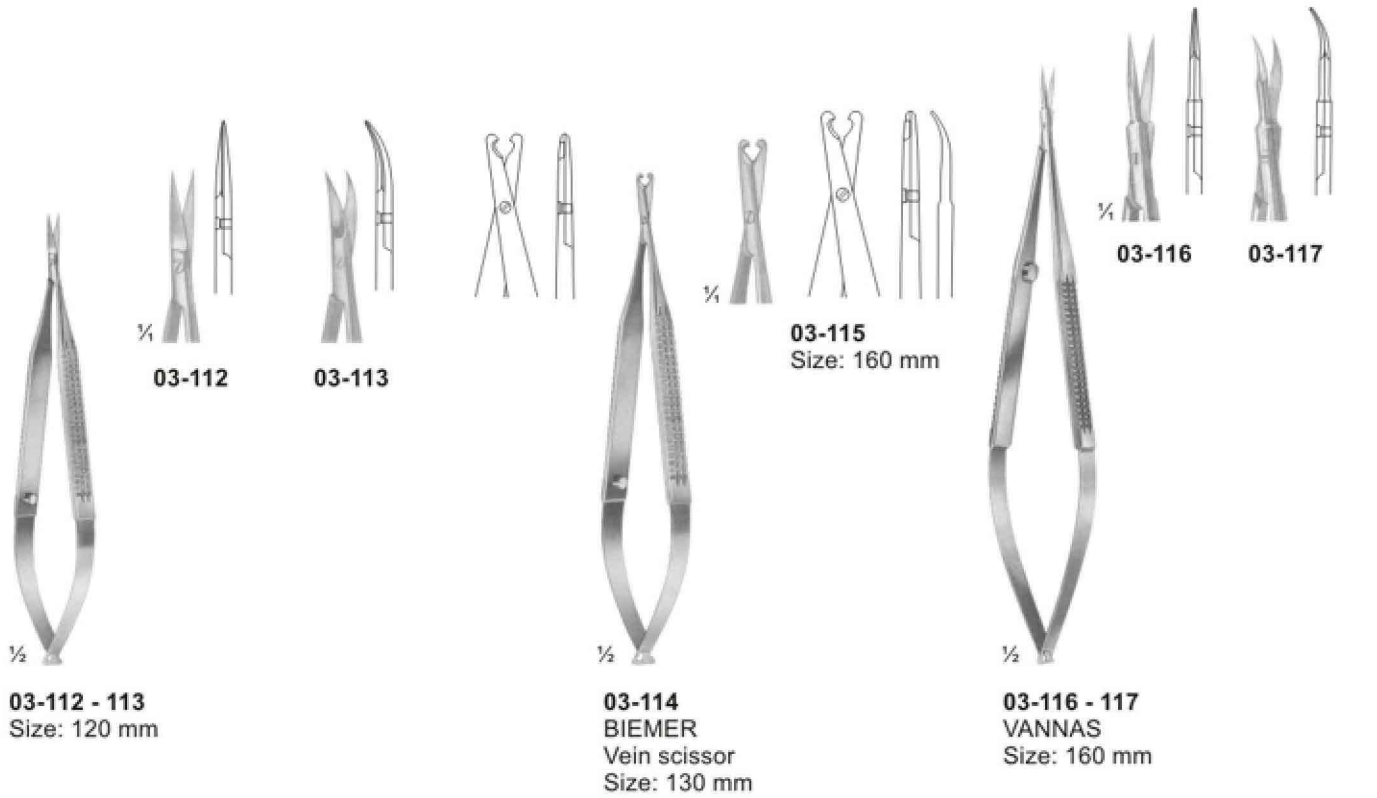

Micro Scissors (Spring Type) bayonet-Shaped



03-122
YASARGIL
Size: 245 mm



03-123
45°

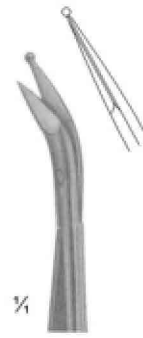

03-124
45°



03-123 - 124
laterally angled
Size: 200 mm

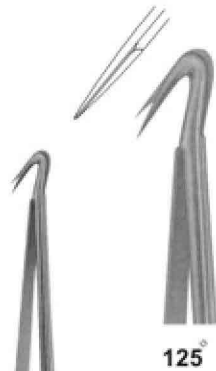

125°



03-125
laterally angled
Size: 190 mm

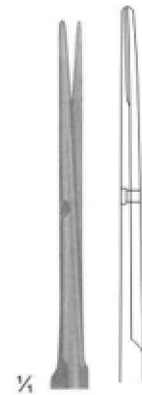

03-126

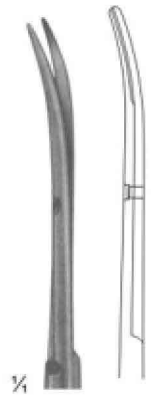

03-127



03-126 - 127
YASARGIL
Size: 225 mm

Delicate Scissors

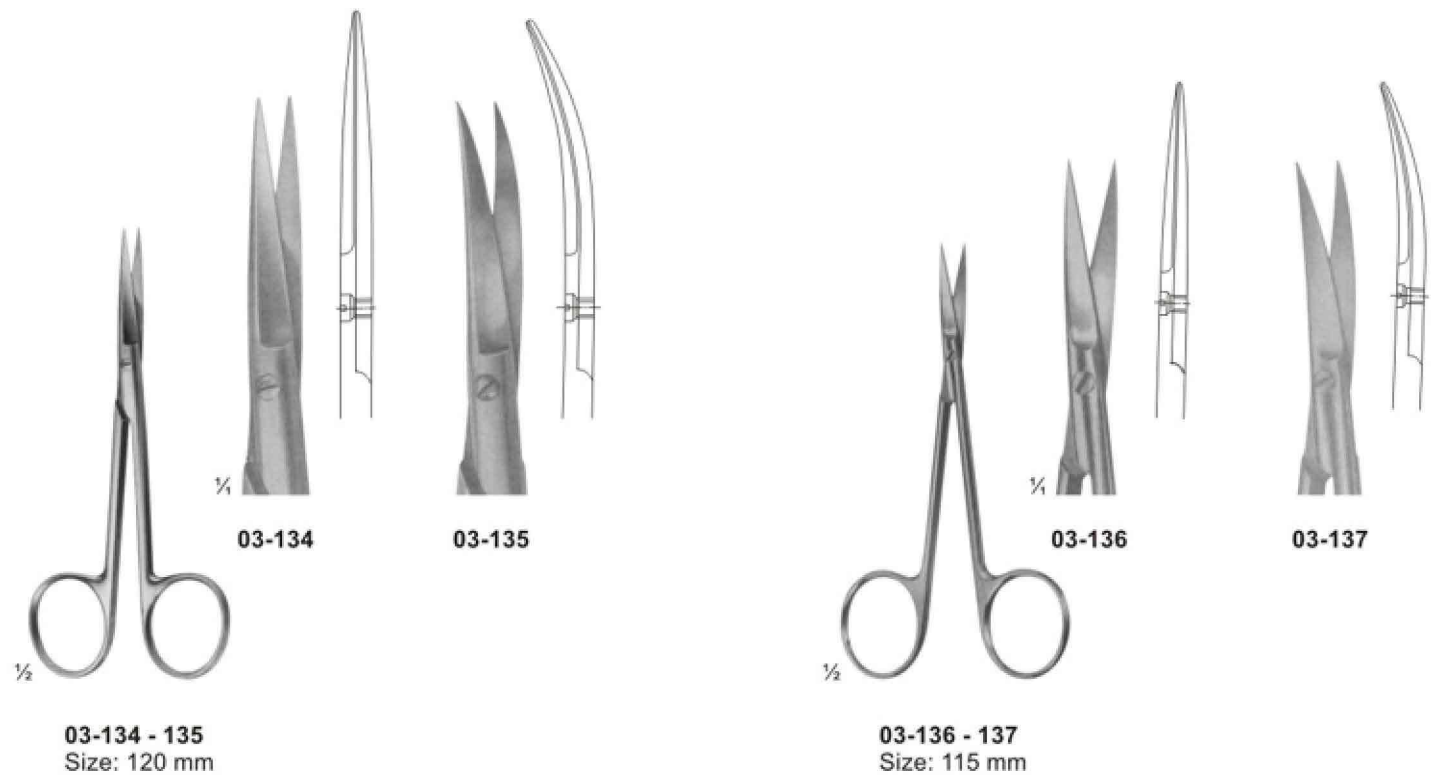
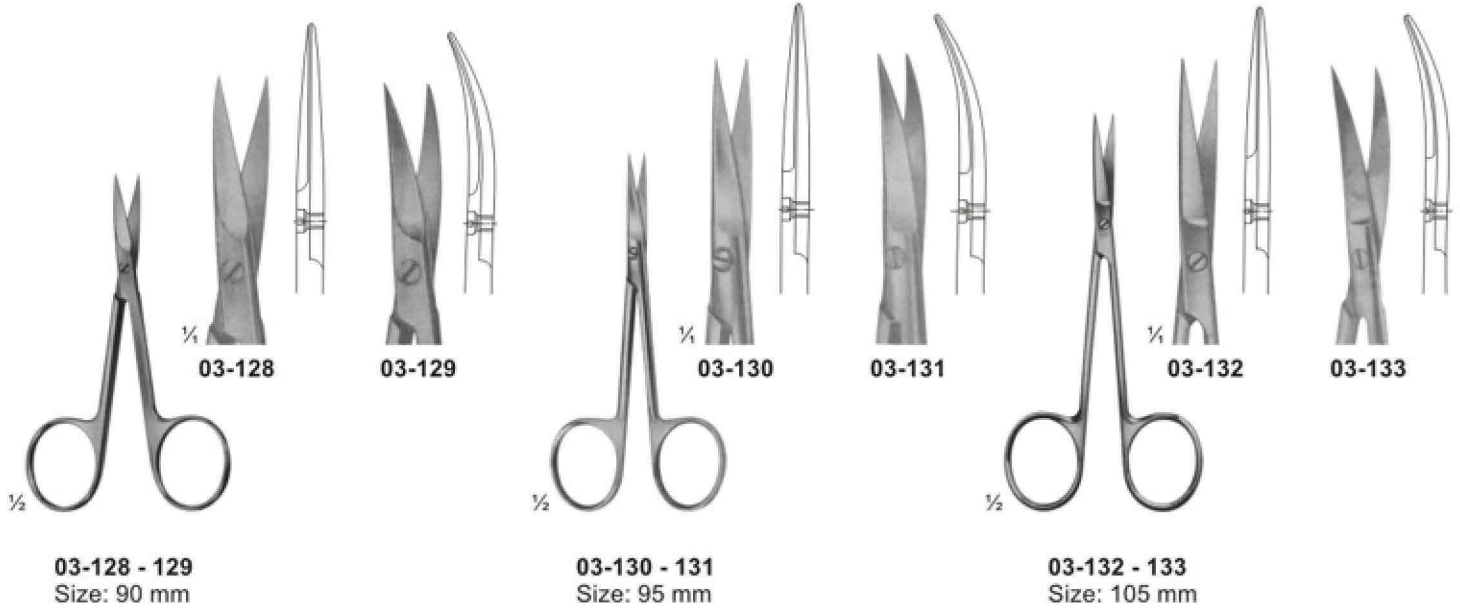

Delicate Scissors

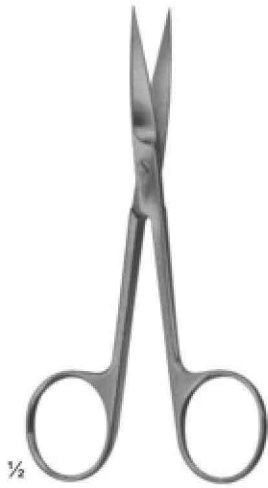

03-138 - 140
Size: 120 mm



03-138



03-139



03-140



03-141 - 144
Size: 130 mm

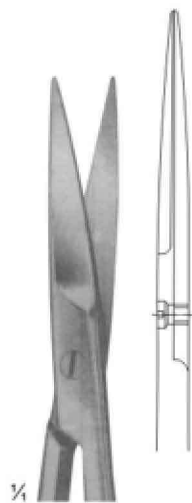

03-141

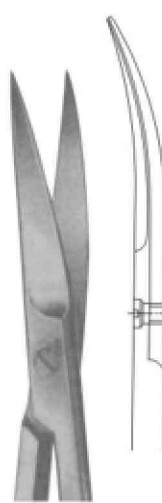

03-142



03-143

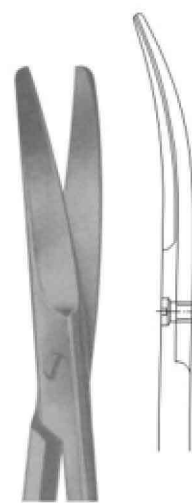

03-144



Surgical Scissors

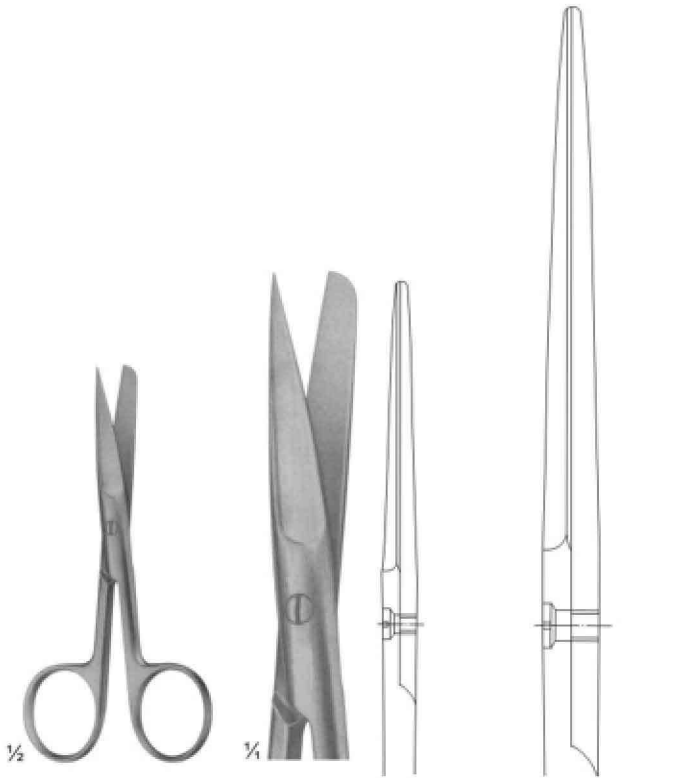

03-145 - 153 (Standard types)
 03-145 (105 mm)
 03-146 (115 mm)
 03-147 (130 mm)
 03-148 (145 mm)
 03-149 (150 mm)
 03-150 (165 mm)
 03-151 (175 mm)
 03-152 (185 mm)
 03-153 (200 mm)

03-145
 Size: 105 mm

03-153
 Size: 200 mm



03-154 - 160 (Standard types)
 03-154 (115 mm)
 03-155 (130 mm)
 03-156 (145 mm)
 03-157 (150 mm)
 03-158 (165 mm)
 03-159 (175 mm)
 03-160 (185 mm)

03-154
 Size: 115 mm

03-160
 Size: 185 mm

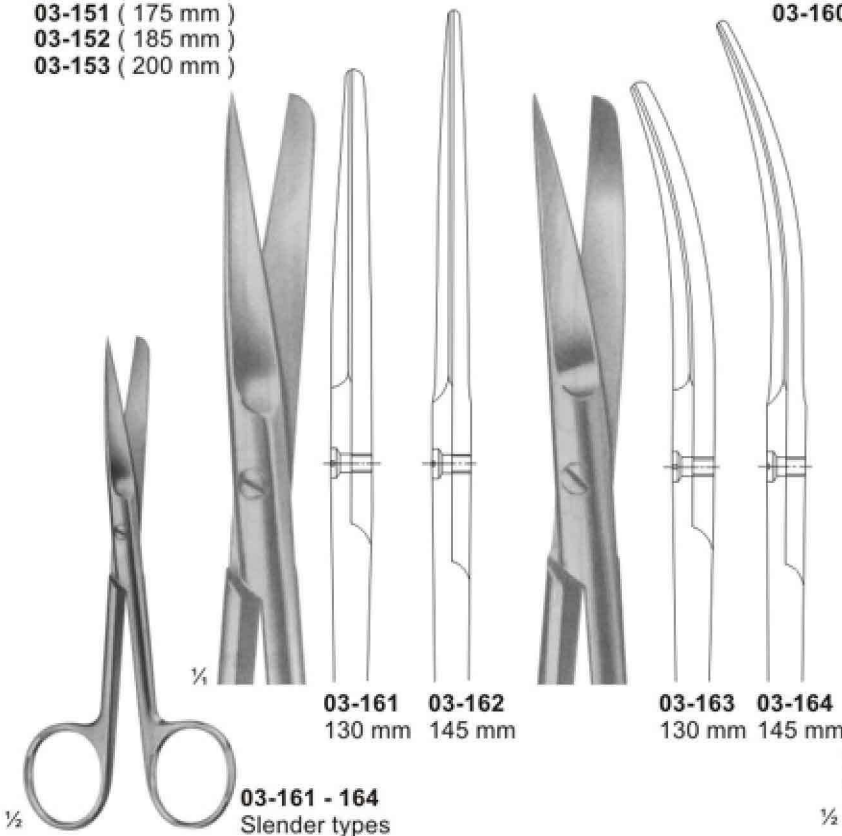

03-161
 130 mm

03-162
 145 mm

03-161 - 164
 Slender types

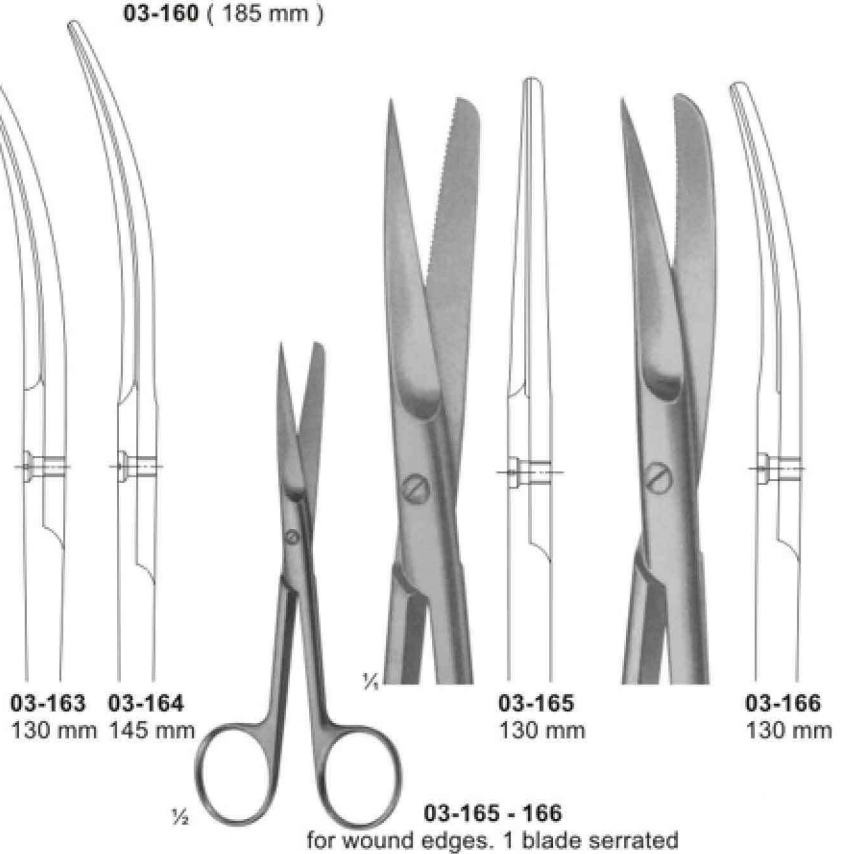

03-165
 130 mm

03-166
 130 mm

03-165 - 166
 for wound edges. 1 blade serrated

Surgical Scissors

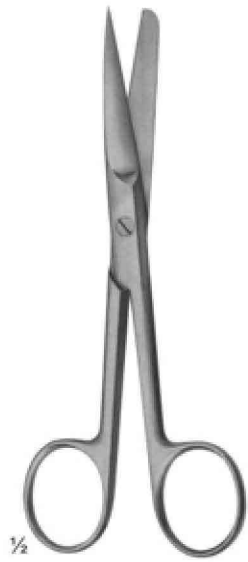

½

03-167 - 169
DEAVER
with flat lock

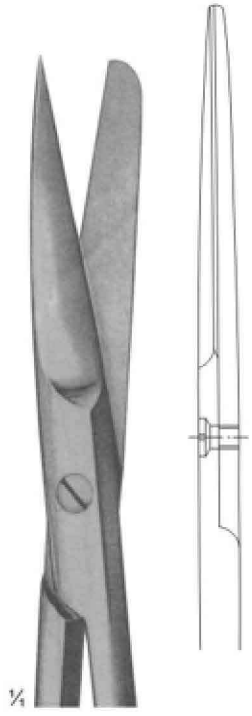

¼

03-167
Size: 145 mm

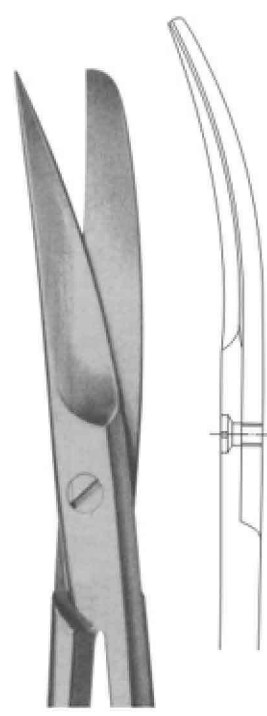

03-168
Size: 145 mm

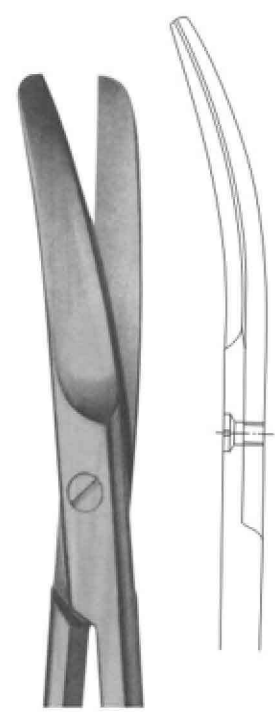

03-169
Size: 145 mm



½

03-170 - 172
Incision scissors

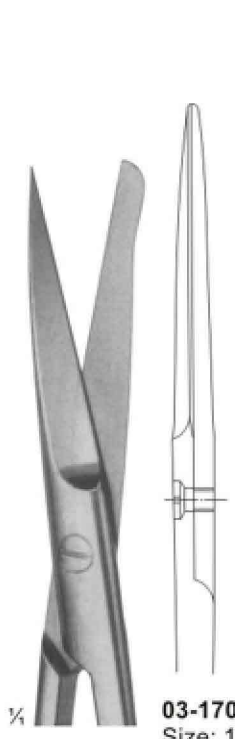

¼

03-170
Size: 130 mm



03-171
Size: 145 mm



03-172
Size: 165 mm

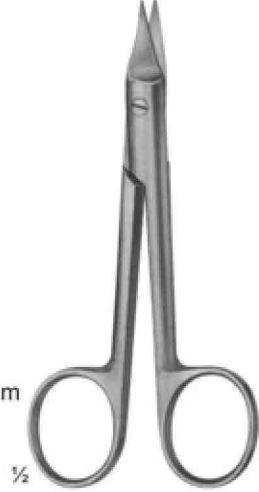

½

03-173
SYSTRUNK
Nail splitting scissors

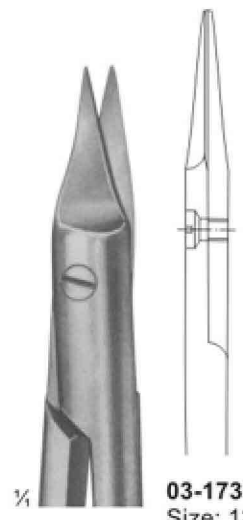

¼

03-173
Size: 130 mm

Dissecting Scissors

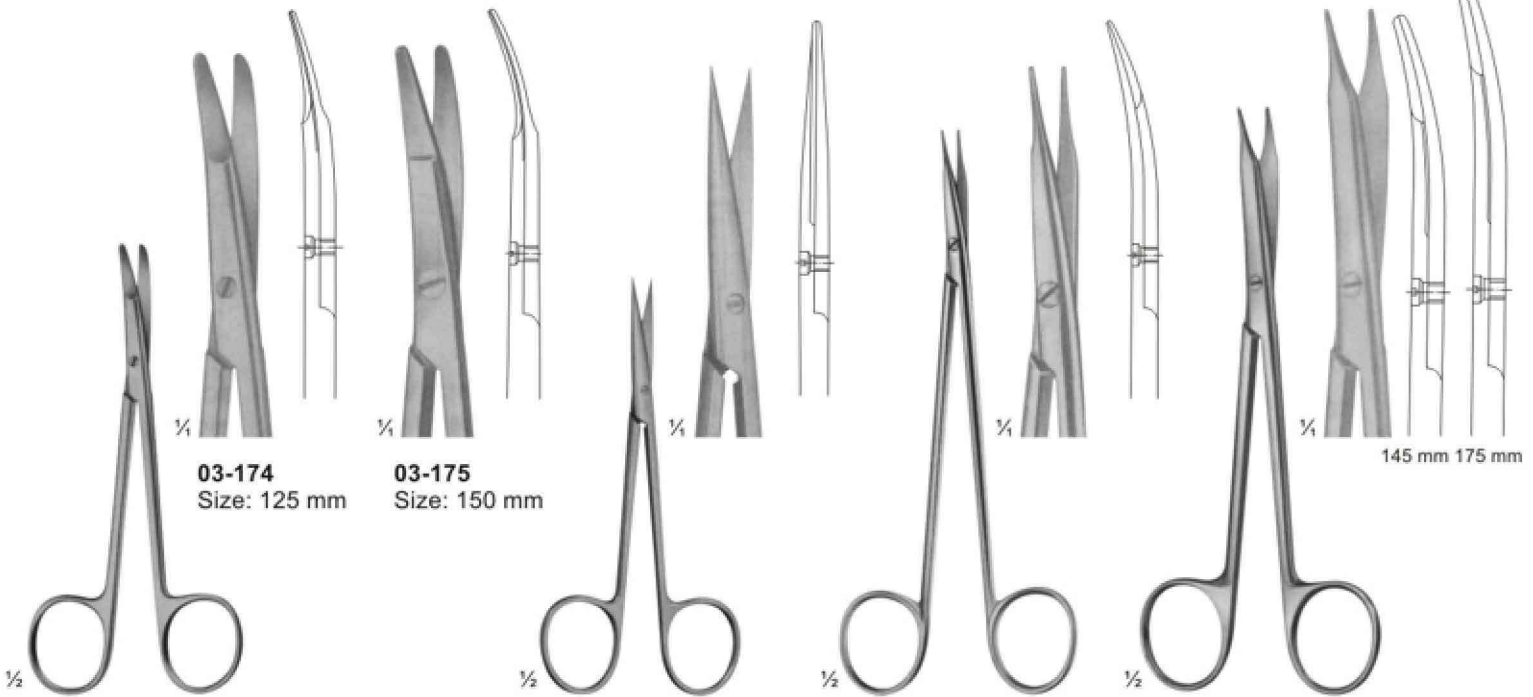

03-174 - 175
KILNER
 Special flat points for dissecting and undermining the skin

03-176
KILNER
 Fine dissecting scissors
 Size: 115 mm

03-177
JAMESON
 Dissecting scissors
 Size: 150 mm

03-178
REYNOLDS
 Dissecting scissors
 Size: 145 - 175 mm

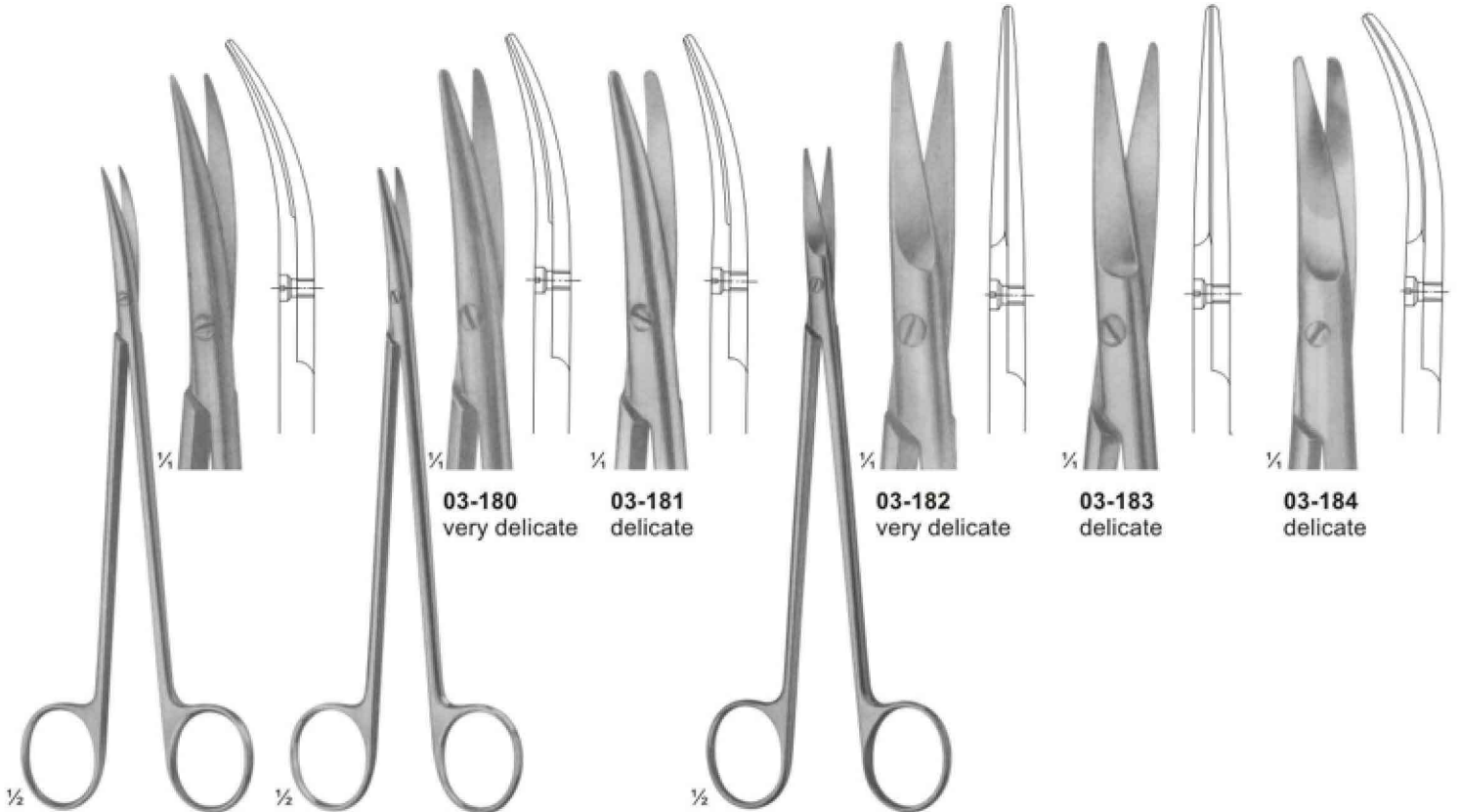

03-179
DE BAKEY
 Arteriotomy scissors
 Size: 175 mm

03-180 - 181
TOENNIS ADSON
 Dissecting scissors
 Size: 175 mm

03-182 - 184
TOENNIS
 Dissecting scissors
 Size: 180 mm

Dissecting Scissors

03-185

03-185 - 186
MAYO-STILLE
with chamfered blades
03-185 (140 mm)
03-186 (170 mm)

MAYO-STILLE
03-187 (140 mm)
03-188 (170 mm)

03-189

MAYO
with chamfered blades
03-189 (190 mm)
03-190 (215 mm)

MAYO
03-191
Size: 190 mm
03-192
Size: 215 mm

03-193
Size: 170 mm

03-194
Size: 170 mm

03-193 - 194
MAYO-NOBLE
broad pattern

03-195
Size: 230 mm

03-196
Size: 230 mm

03-195 - 196
MAYO-HARRINGTON

Scissors for Cardiovascular and Neuro-Surgery



03-197
OLIVECRONA
Dura scissors

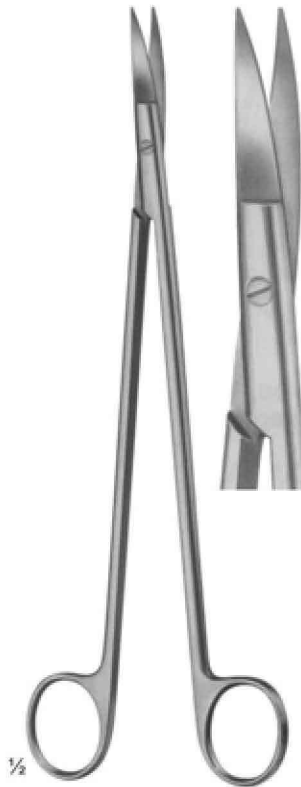

03-198
STRULLY
pointed
Size: 220 mm

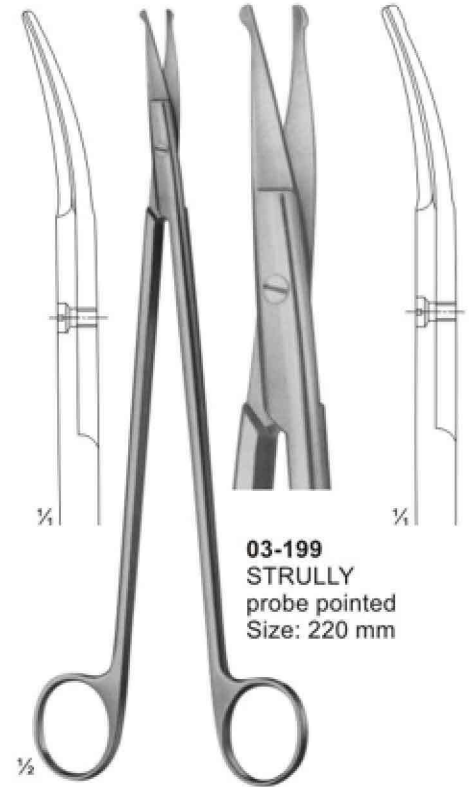

03-199
STRULLY
probe pointed
Size: 220 mm

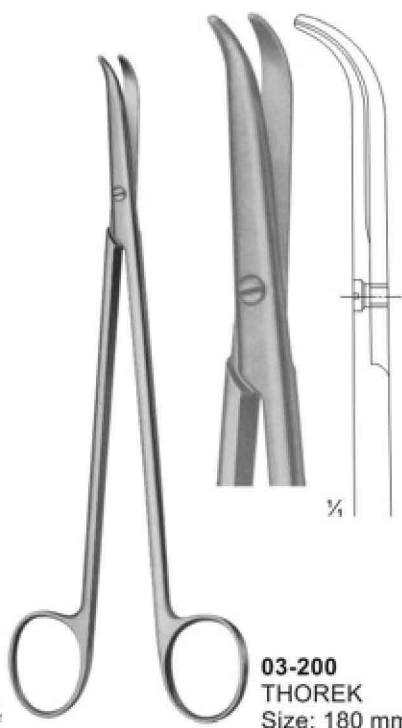

03-200
THOREK
Size: 180 mm

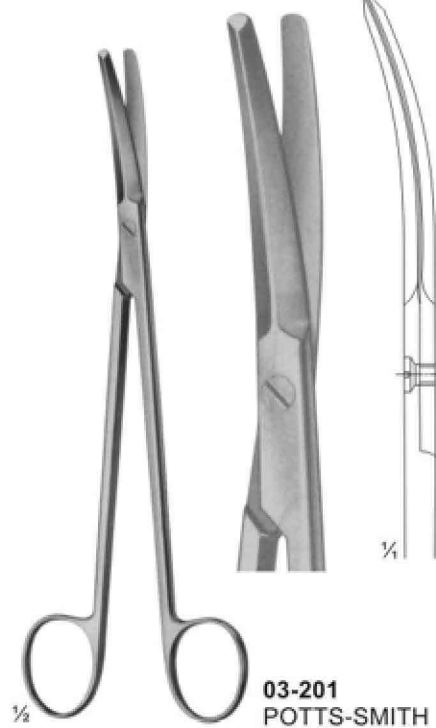

03-201
POTTS-SMITH
Size: 190 mm

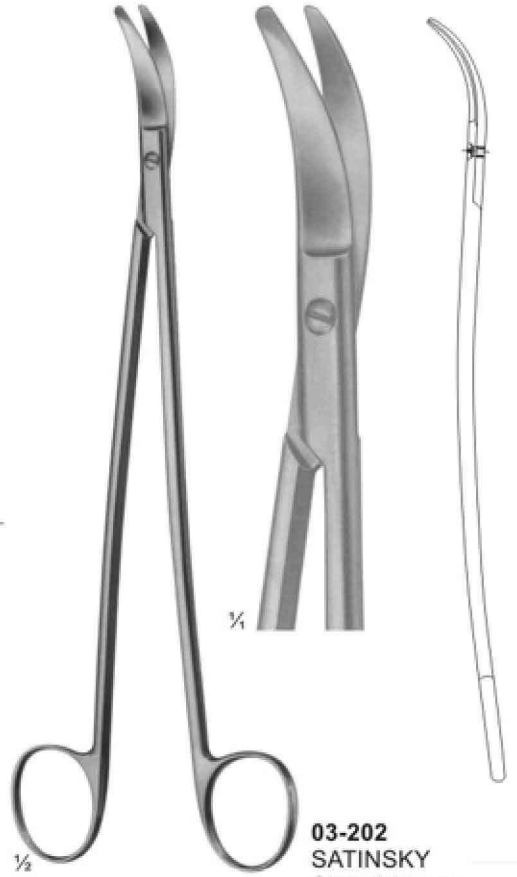

03-202
SATINSKY
Size: 245 mm

Delicate, Nasal and Tonsil Scissors

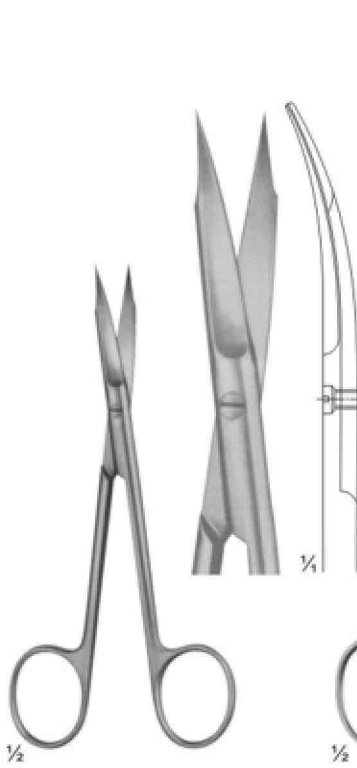

03-203
1 finely toothed blade
Size: 130 mm

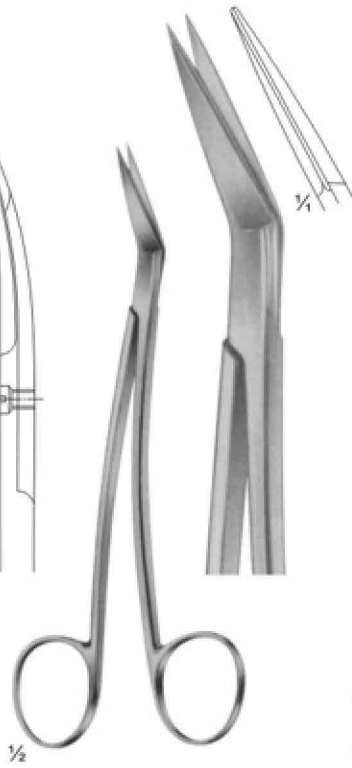

03-204
LOCKLIN
curved sideways,
1 toothed blade
Size: 155 mm

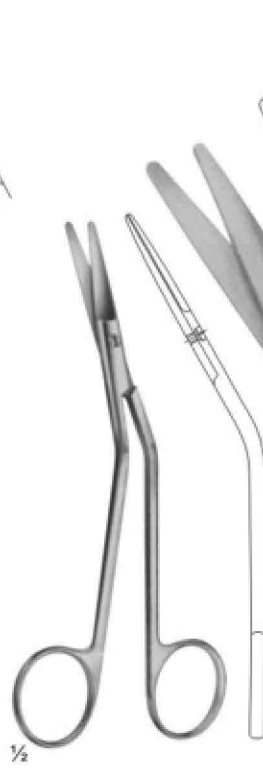

03-205
FOMON
blades serrated
Size: 145 mm

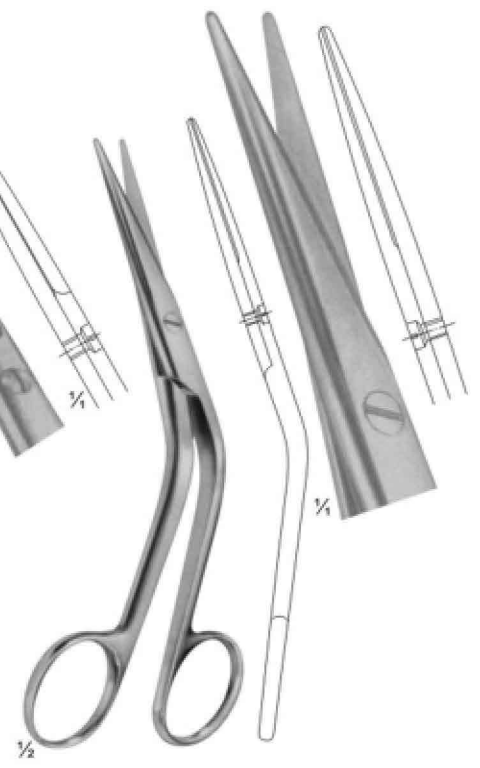

03-206
COTTLE
Size: 165 mm



03-207
HEYMANN-KNIGHT
Size: 175 mm

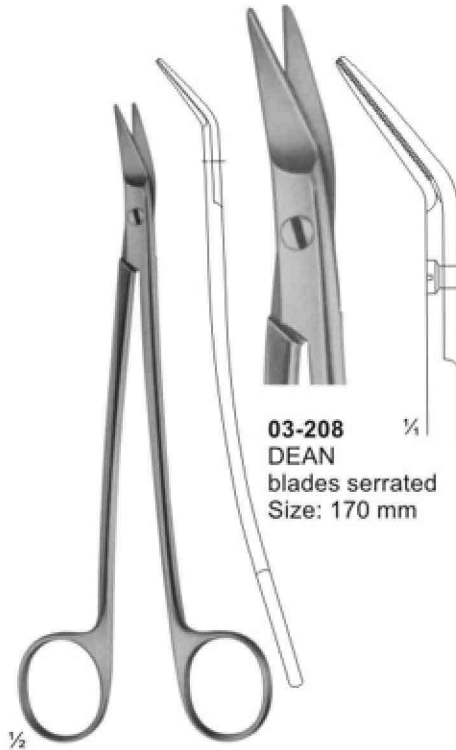

03-208
DEAN
blades serrated
Size: 170 mm

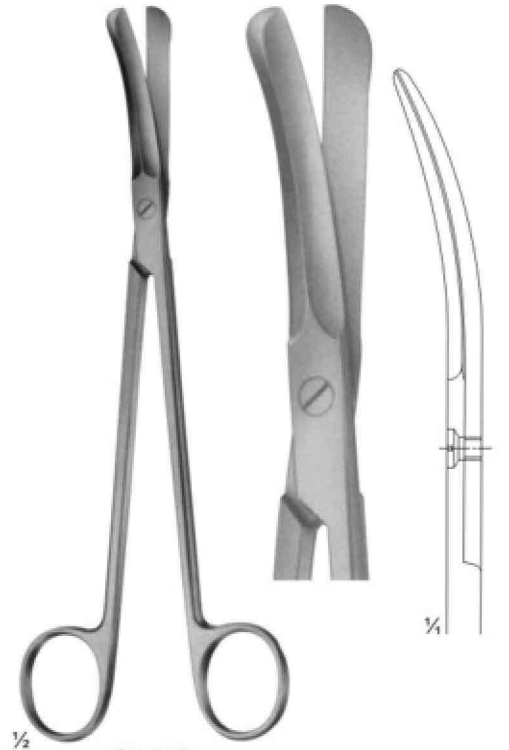

03-209
GOOD
Size: 195 mm

Bone Shears

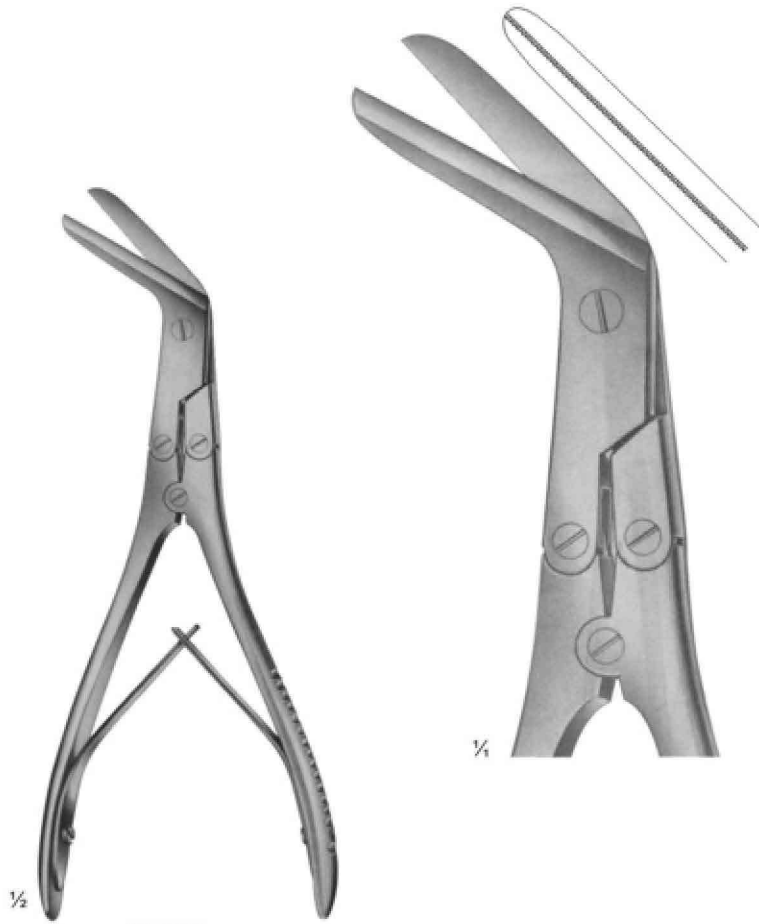

03-210
KILLIAN
Size: 200 mm



03-211 - 03-212

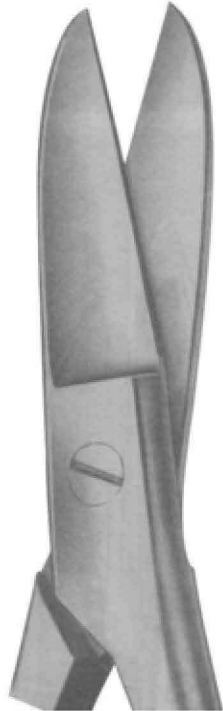

03-211
195 mm



03-212
225 mm



Scissors for deep operations and for Gynaecology

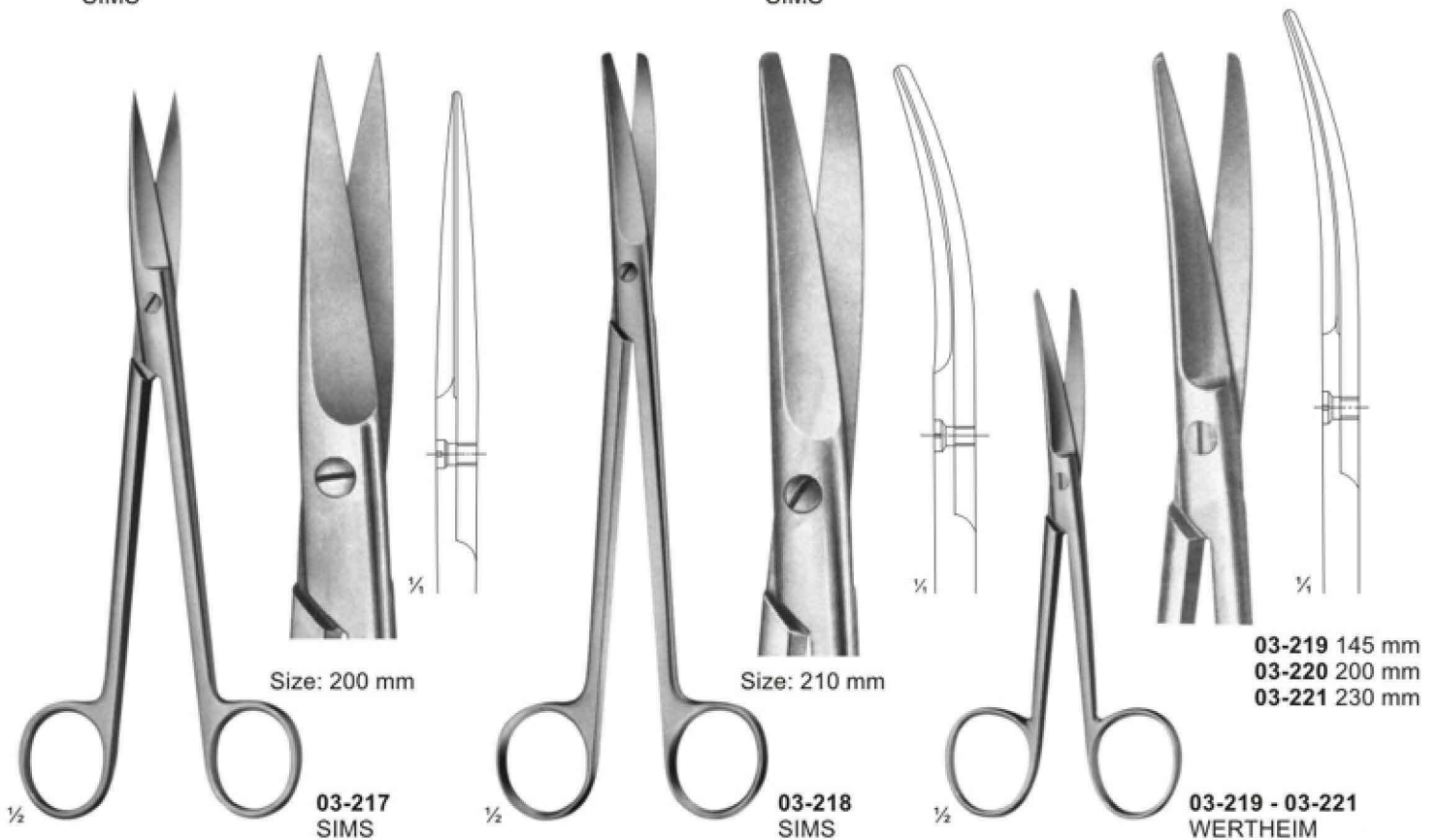
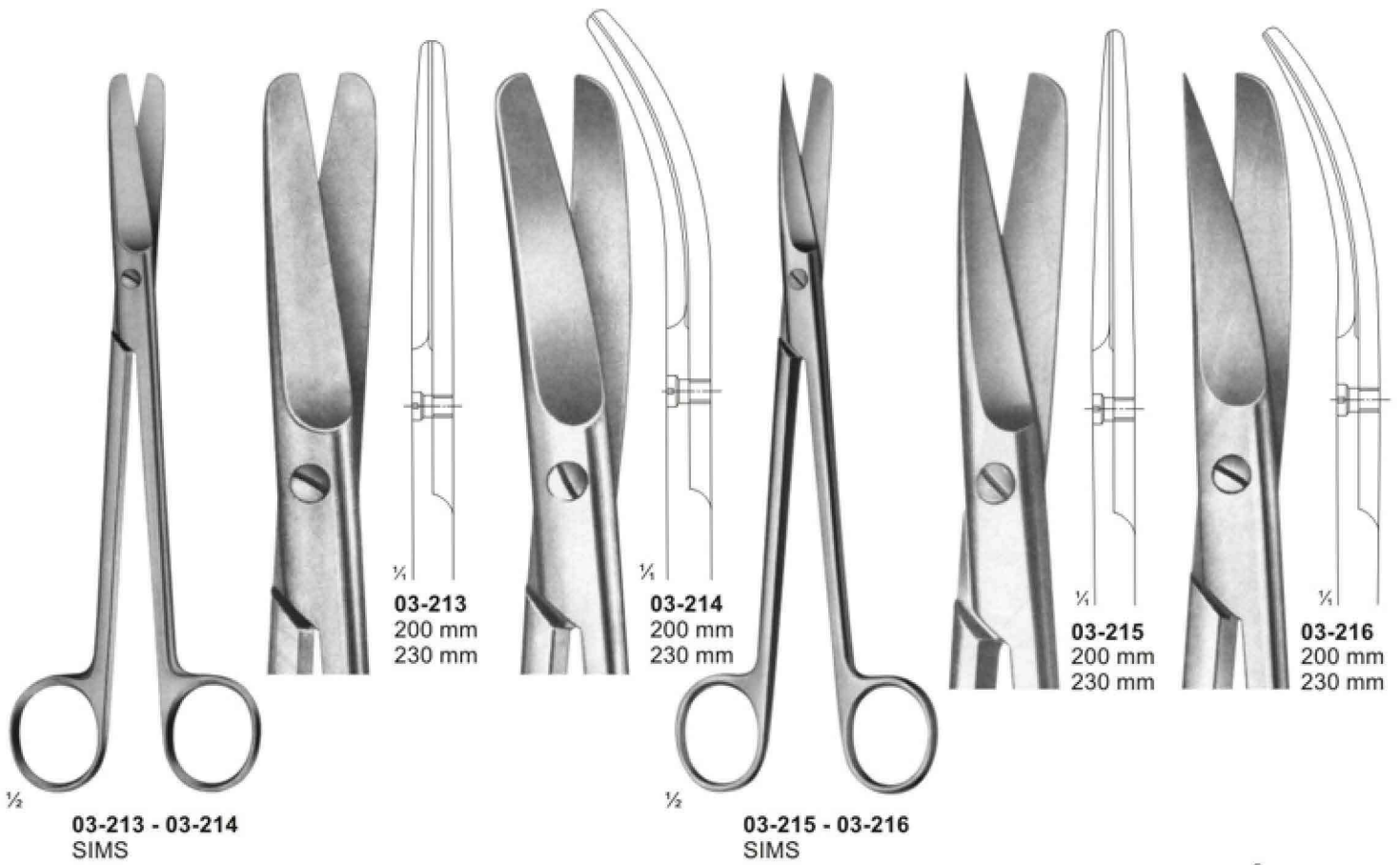

Scissors for Obstetrics



03-222
SCHUMACHER
 Umbilical cord scissors
 Size: 155 mm

03-223
 Umbilical cord scissors
 Size: 105 mm

03-224
 Umbilical cord scissors

135 mm

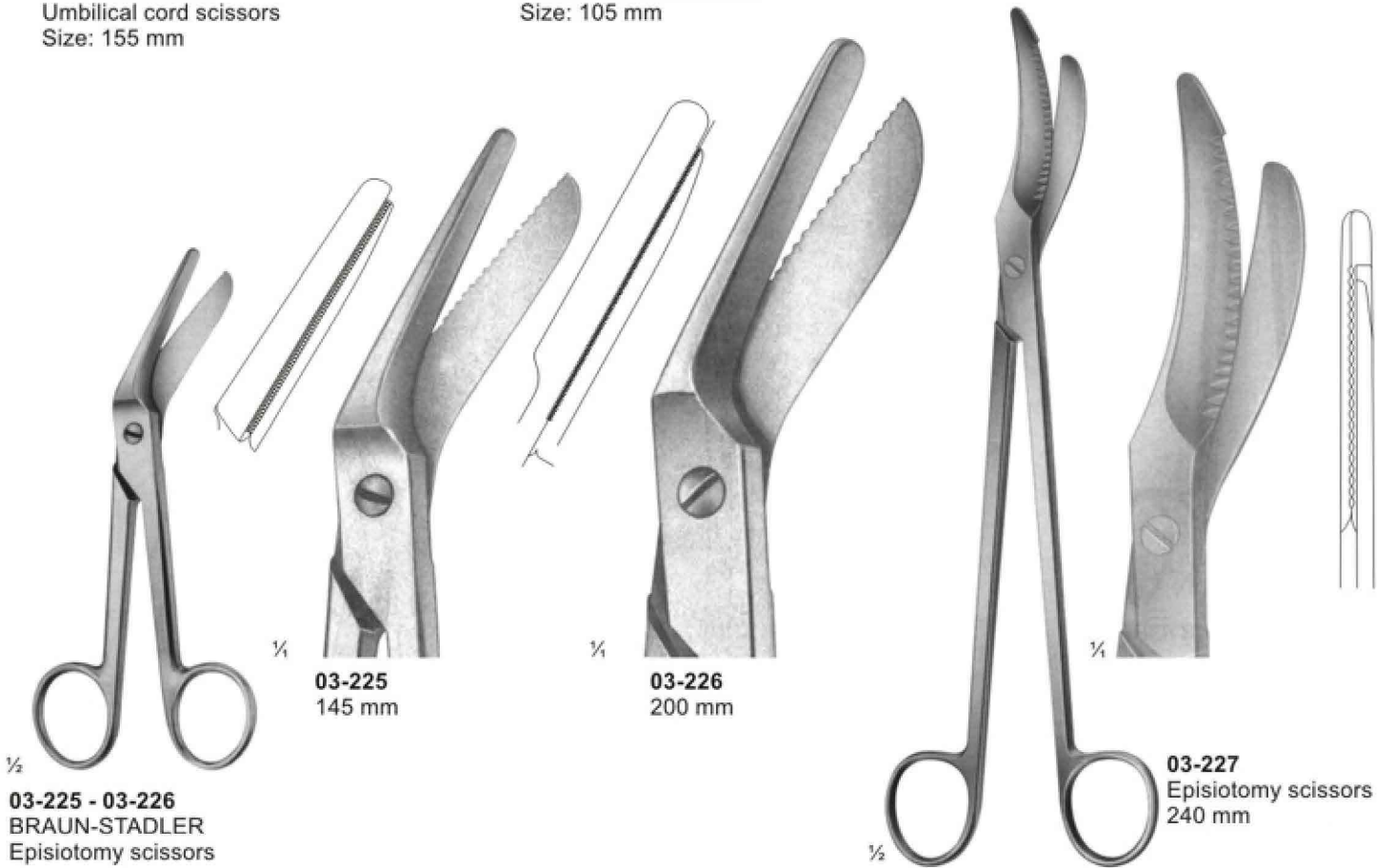

03-225 - 03-226
BRAUN-STADLER
 Episiotomy scissors

03-225
 145 mm

03-226
 200 mm

03-227
 Episiotomy scissors
 240 mm

Wire and Plate Scissors

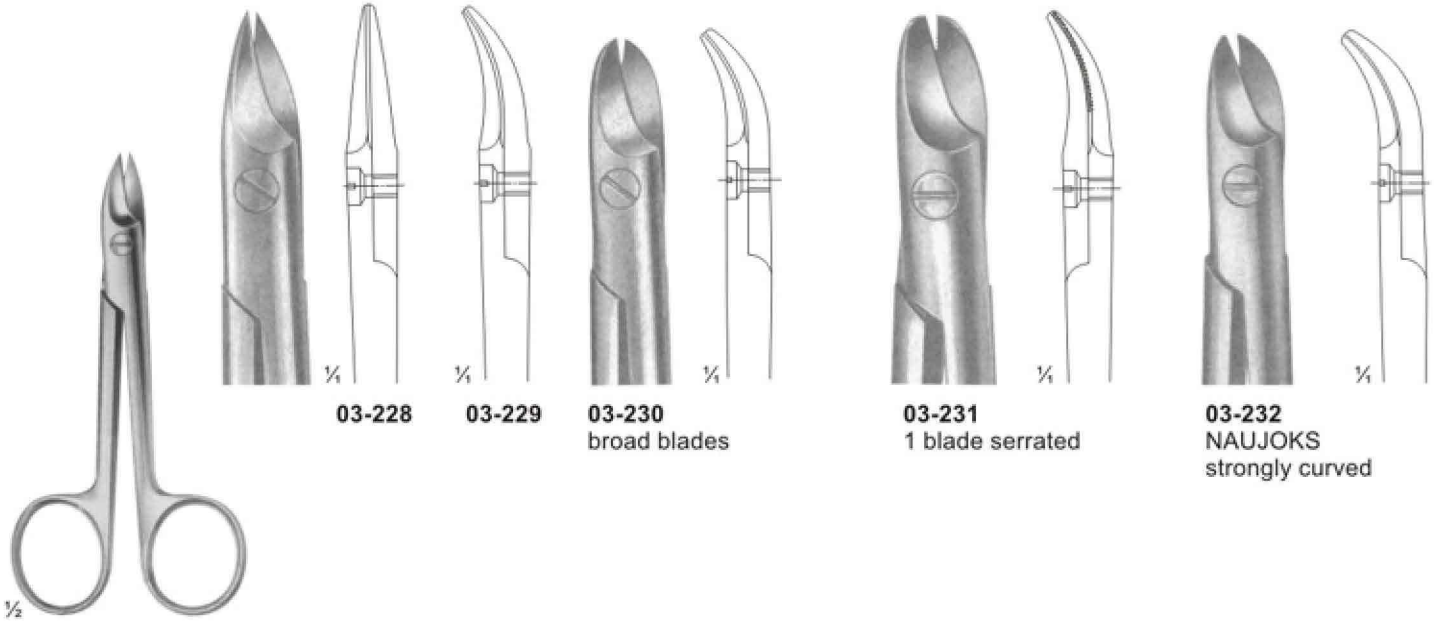

03-228

03-229

03-230
broad blades

03-231
1 blade serrated

03-232
NAUJOKS
strongly curved

03-228 - 03-232
BEEBE
Size: 110 mm

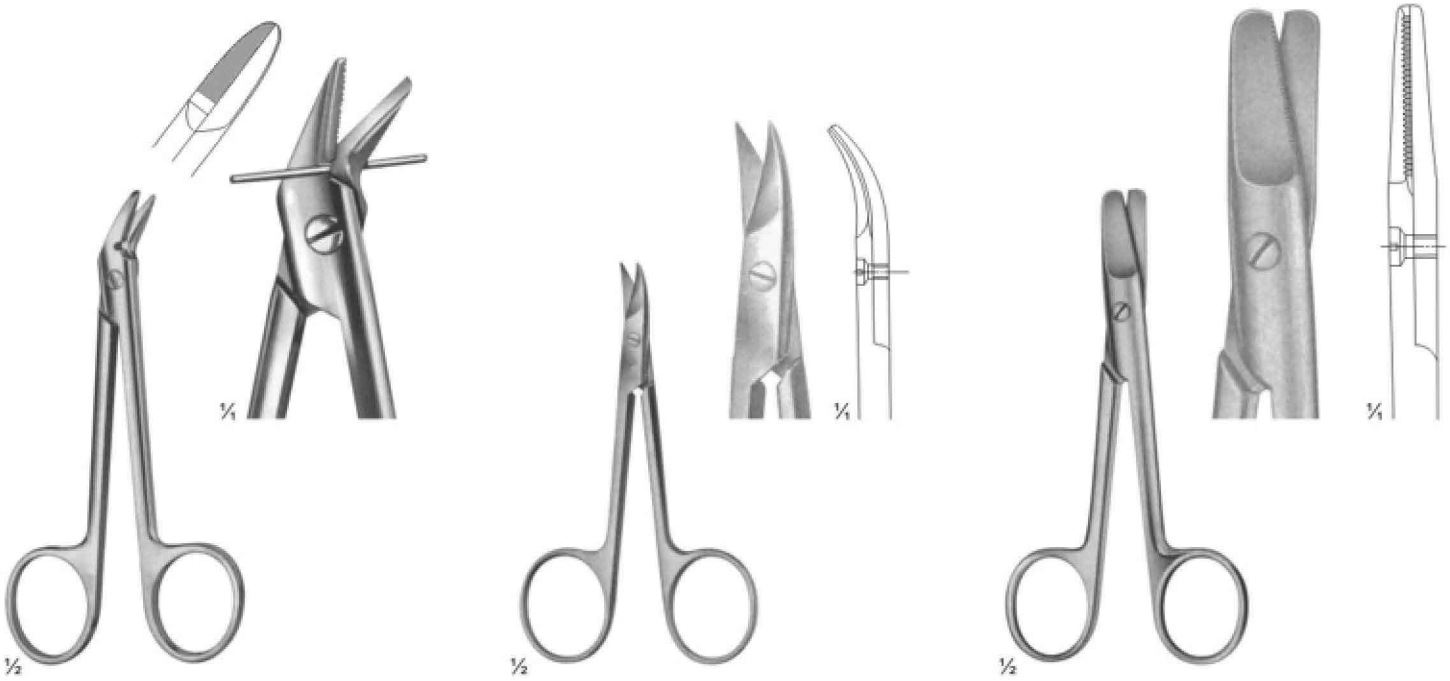

03-233
1 blade serrated
Size: 120 mm

03-234
STRACK
Size: 100 mm

03-235
HARVEY
blades serrated
Size: 125 mm

Bandage and Cloth Scissors



03-236
Universal bandage and cloth scissors,
with toothed edges
180 mm

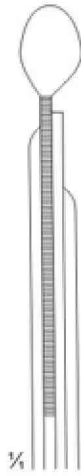

03-237
LISTER
Universal bandage and cloth scissors,
with toothed edges
Size: 145 mm

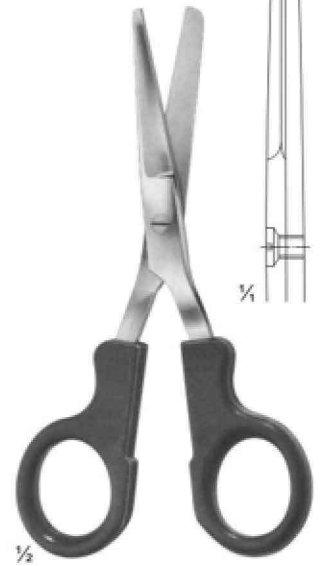
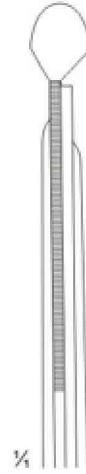

03-238
LISTER
Nurse's scissors
Size: 145 mm

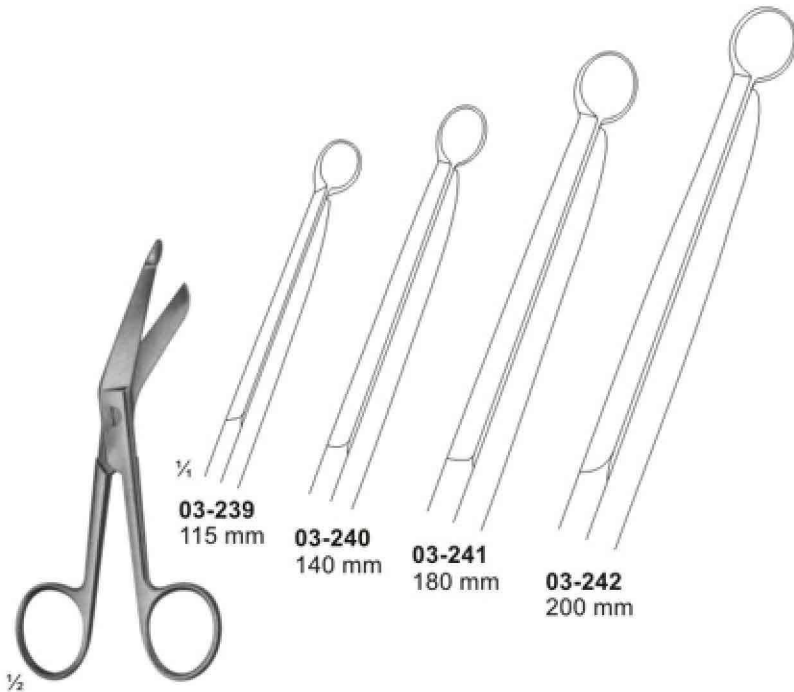

03-239 - 03-242
LISTER

03-239
115 mm

03-240
140 mm

03-241
180 mm

03-242
200 mm

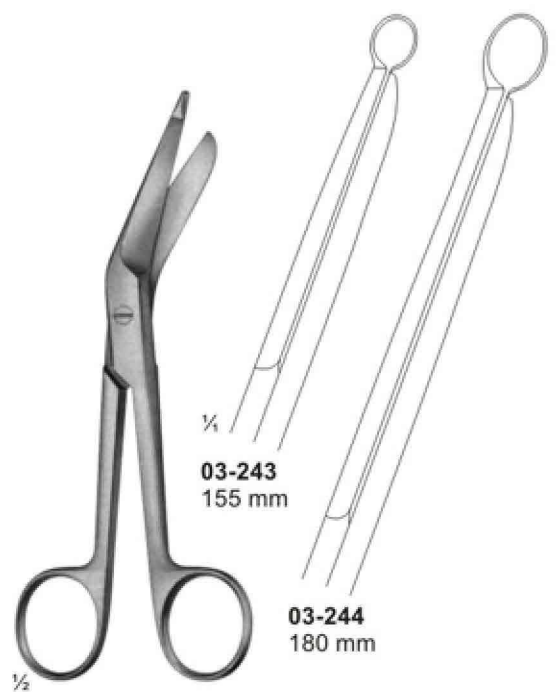

03-243 - 03-244
LISTER

03-243
155 mm

03-244
180 mm

Bandage-, Cloth-, and Plaster Scissors

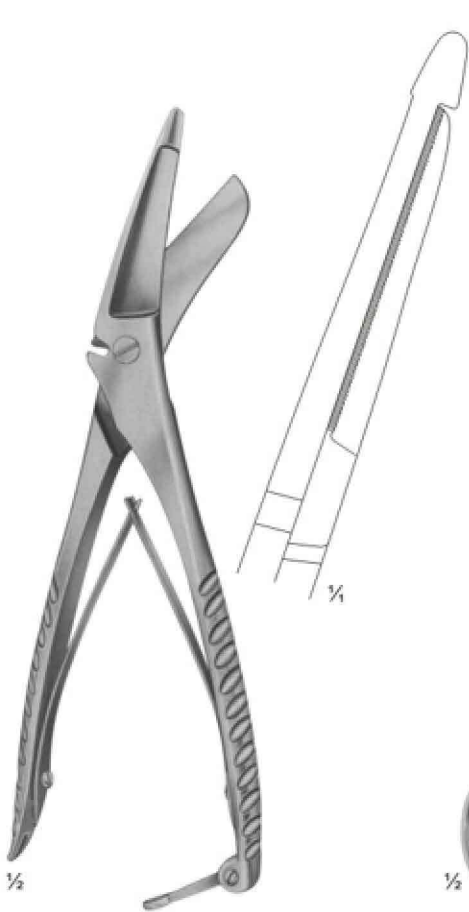

03-245
CLOTH SCISSORS
205 mm

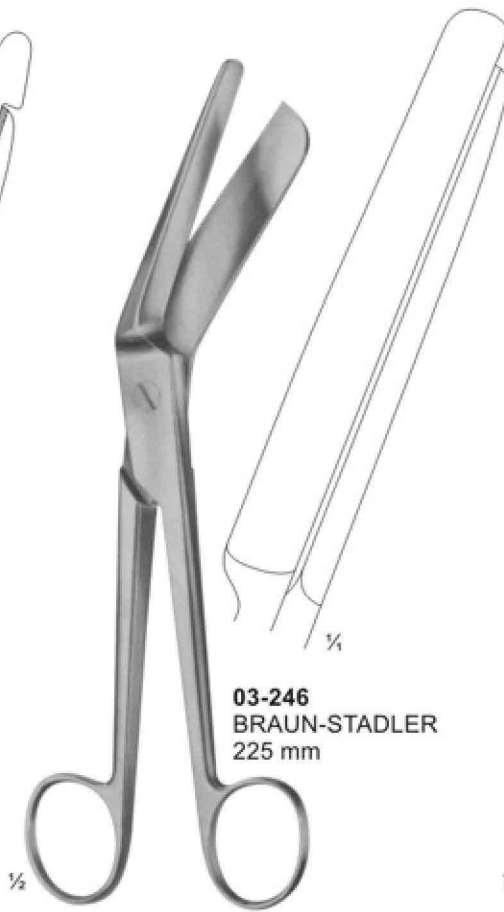

03-246
BRAUN-STADLER
225 mm



03-247
SEUTIN
230 mm

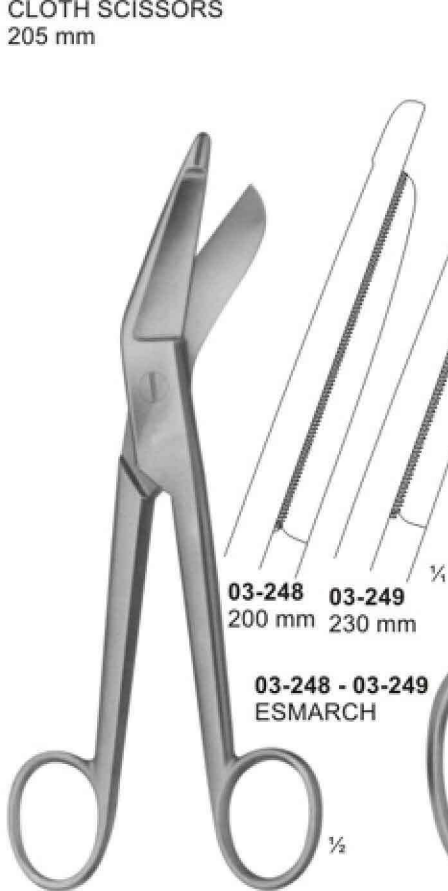

03-248 **03-249**
200 mm 230 mm

03-248 - 03-249
ESMARCH

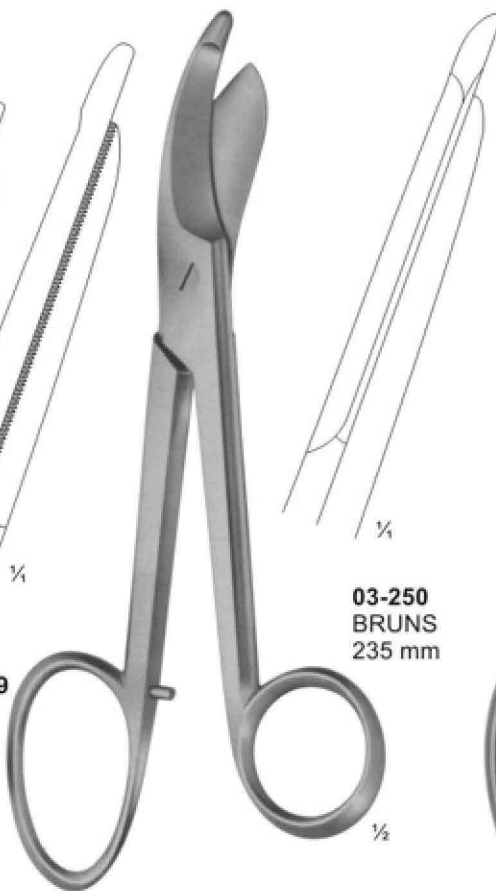

03-250
BRUNS
235 mm

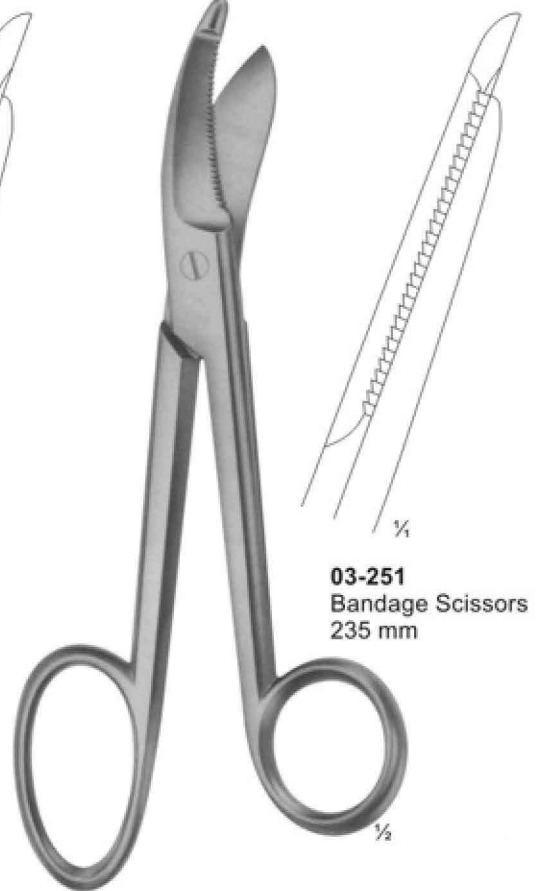

03-251
Bandage Scissors
235 mm

Forceps for grasping tissue, tumors etc.

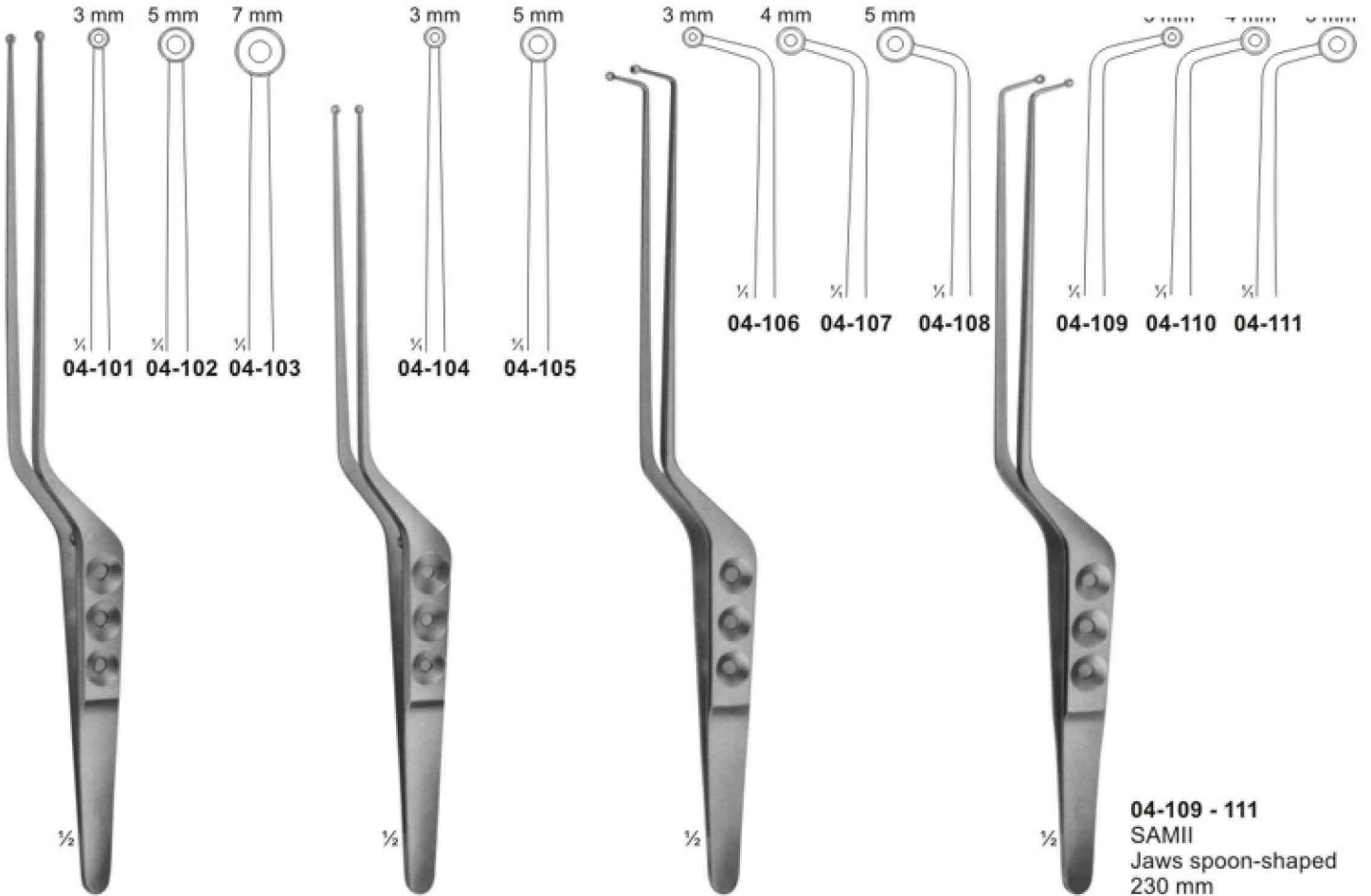

04-101 - 103
YASARGIL-SAMII
Jaws spoon-shaped
240 mm

04-104 - 105
YASARGIL
Jaws spoon-shaped
220 mm

04-106 - 108
SAMII
Jaws spoon-shaped
230 mm

04-109 - 111
SAMII
Jaws spoon-shaped
230 mm

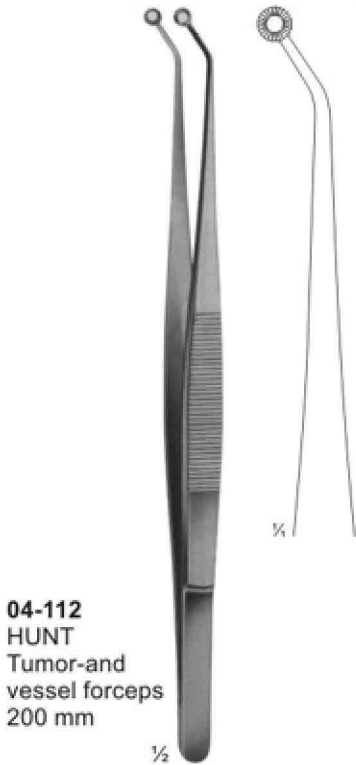

04-112
HUNT
Tumor-and
vessel forceps
200 mm



04-113
HUNT
Tumor-and
vessel forceps
200 mm



04-114
YASARGIL
Tumor-and
vessel forceps
200 mm

Delicate Dissecting, Microscopic, Sterilizing Forceps



04-115
THORPE
Corneal forceps
120 mm



04-116
MICRO-ADSON
120 mm

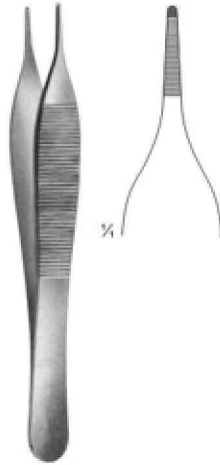

04-117
ADSON
120 mm



04-118
MICRO-ADSON
150 mm



04-119 - 121
100 mm



04-119



04-120



04-121

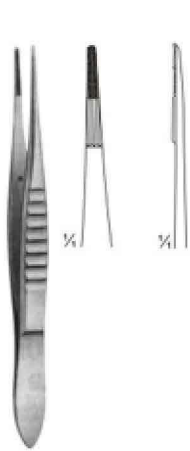

04-122
BONACCOLTO
110 mm



04-123
115 mm



04-124 - 133

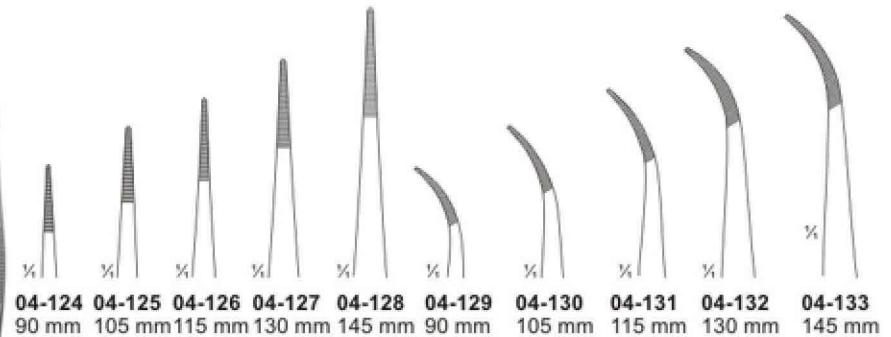

04-124 90 mm **04-125** 105 mm **04-126** 115 mm **04-127** 130 mm **04-128** 145 mm **04-129** 90 mm **04-130** 105 mm **04-131** 115 mm **04-132** 130 mm **04-133** 145 mm



04-134
100 mm



04-135
100 mm



04-136
100 mm

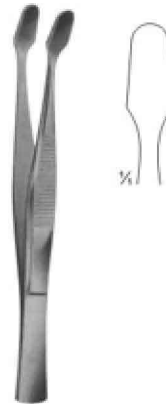

04-137
KUHNE
Cover glass forceps, 105 mm



04-138
160 mm

Delicate Dissecting Forceps

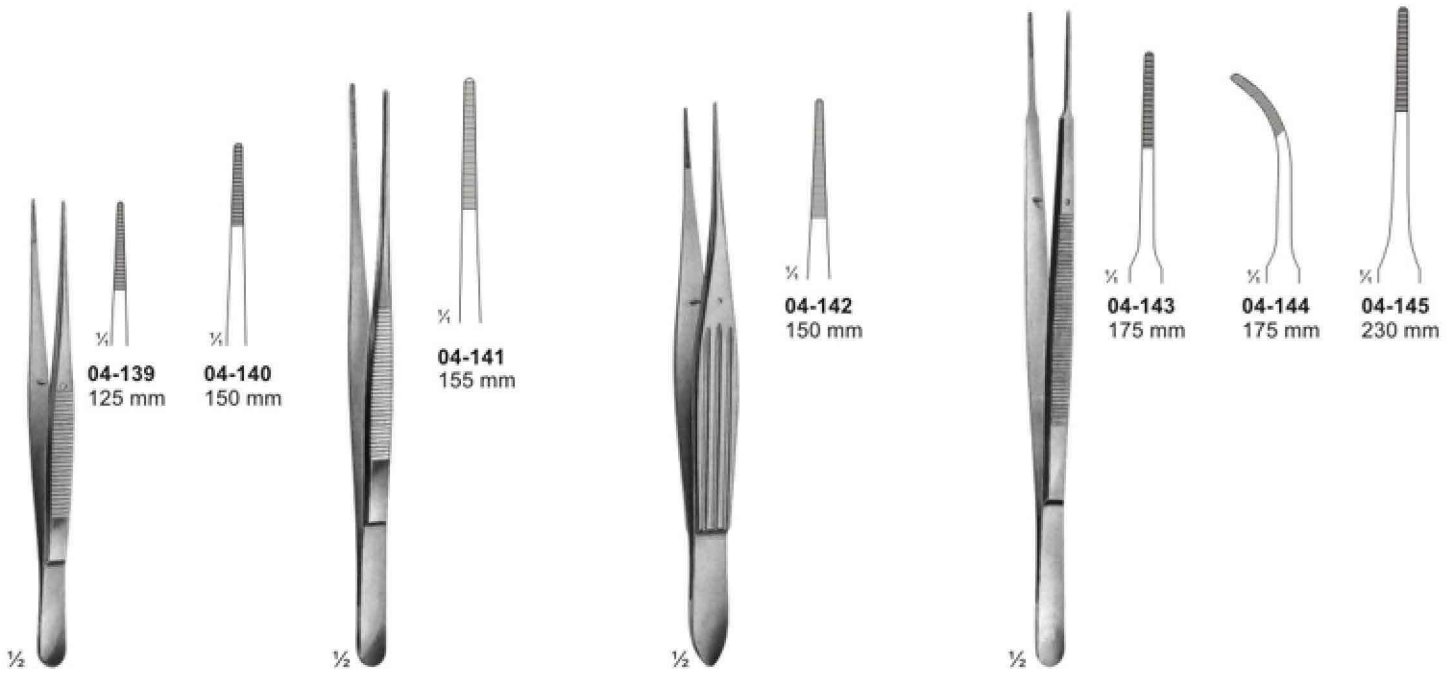

04-139 - 140
SEMKEN

04-141

04-142
MC INDOE

04-143 - 145
GERALD

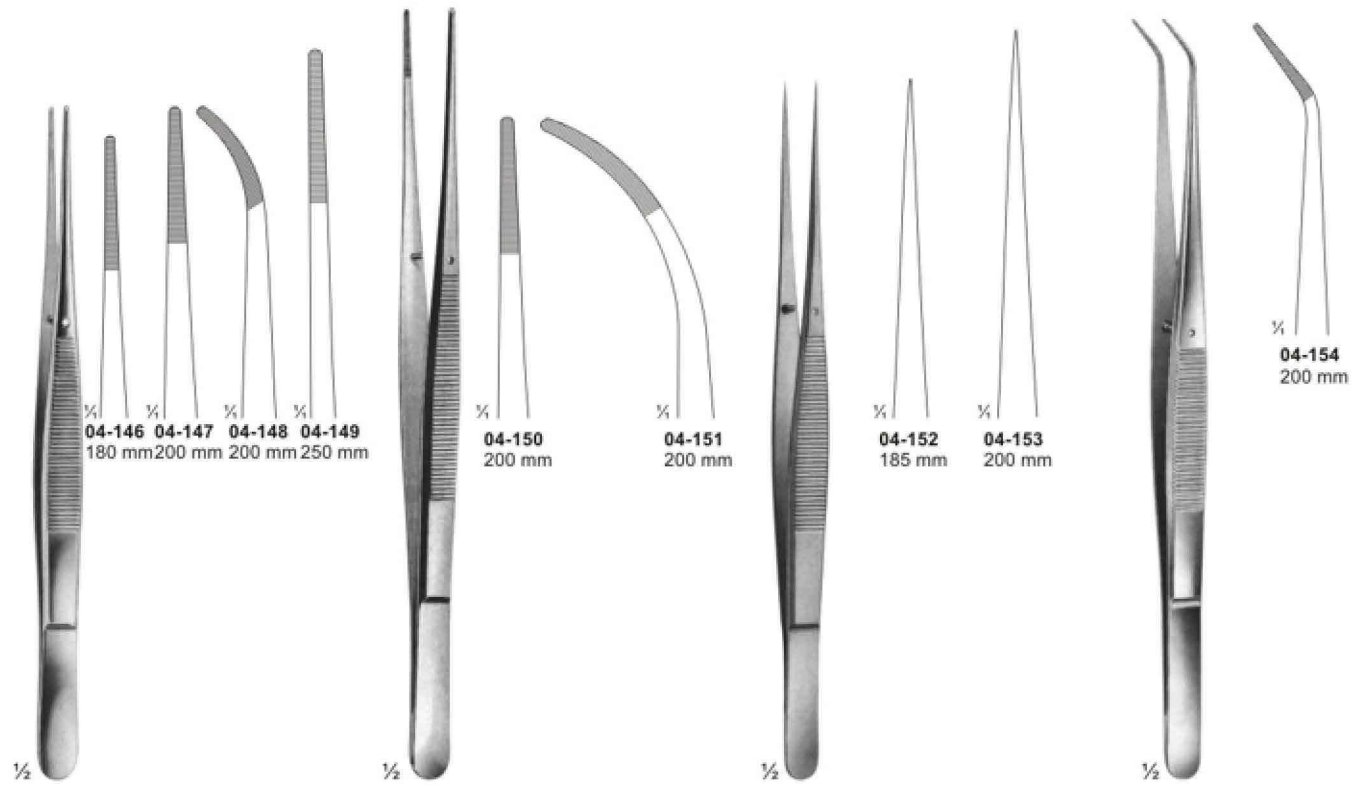

04-146 - 149
CUSHING

04-150 - 151
BROPHY

04-152 - 153
smooth jaws

04-154

Dissecting Forceps

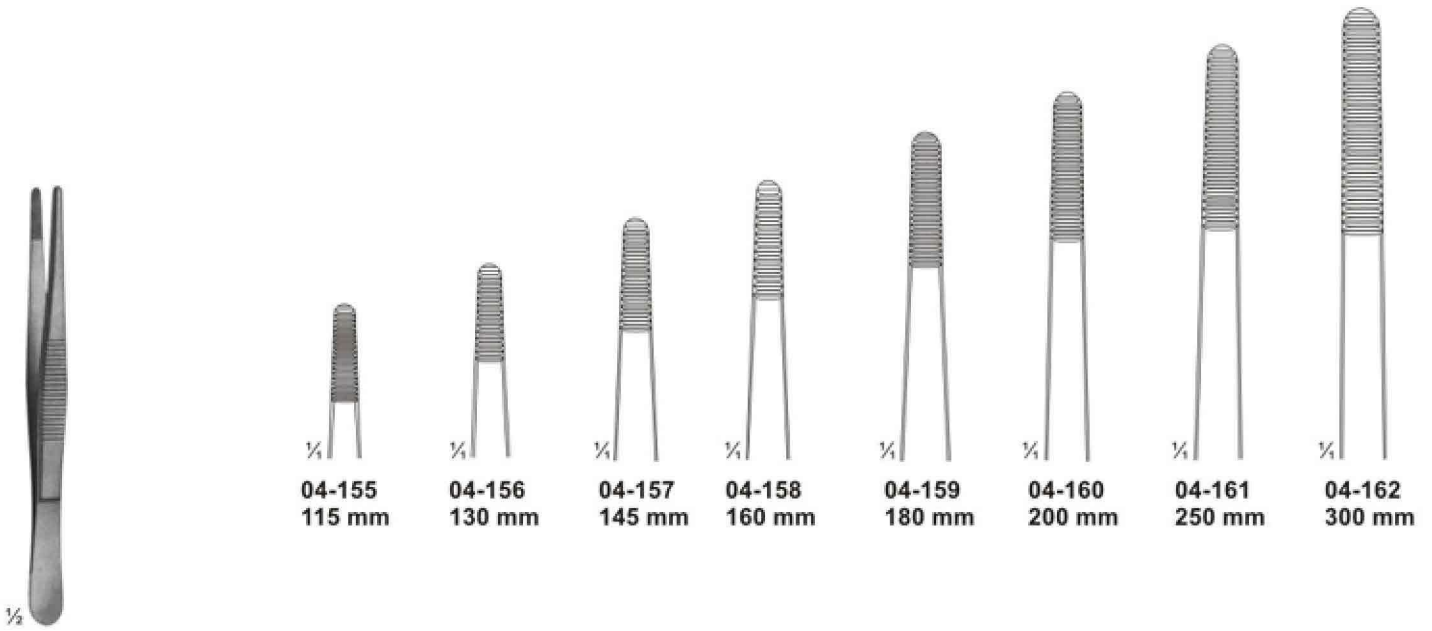

04-155 - 04-162
STANDARD

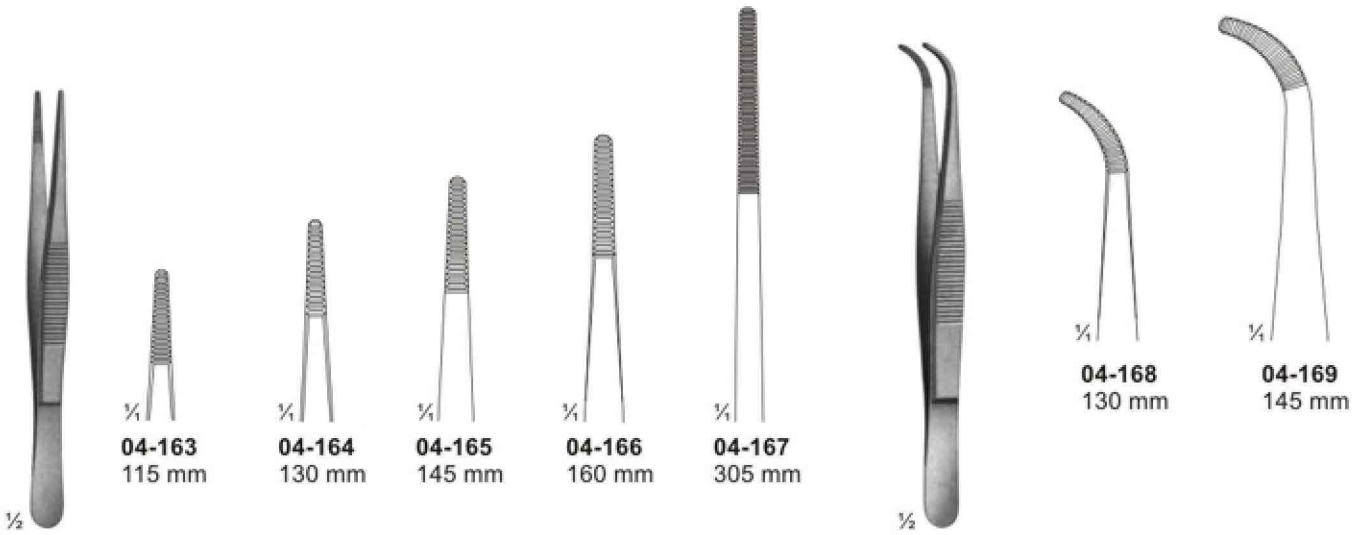

04-163 - 04-167
MEDIUM

04-168 - 04-169
MEDIUM

Forceps

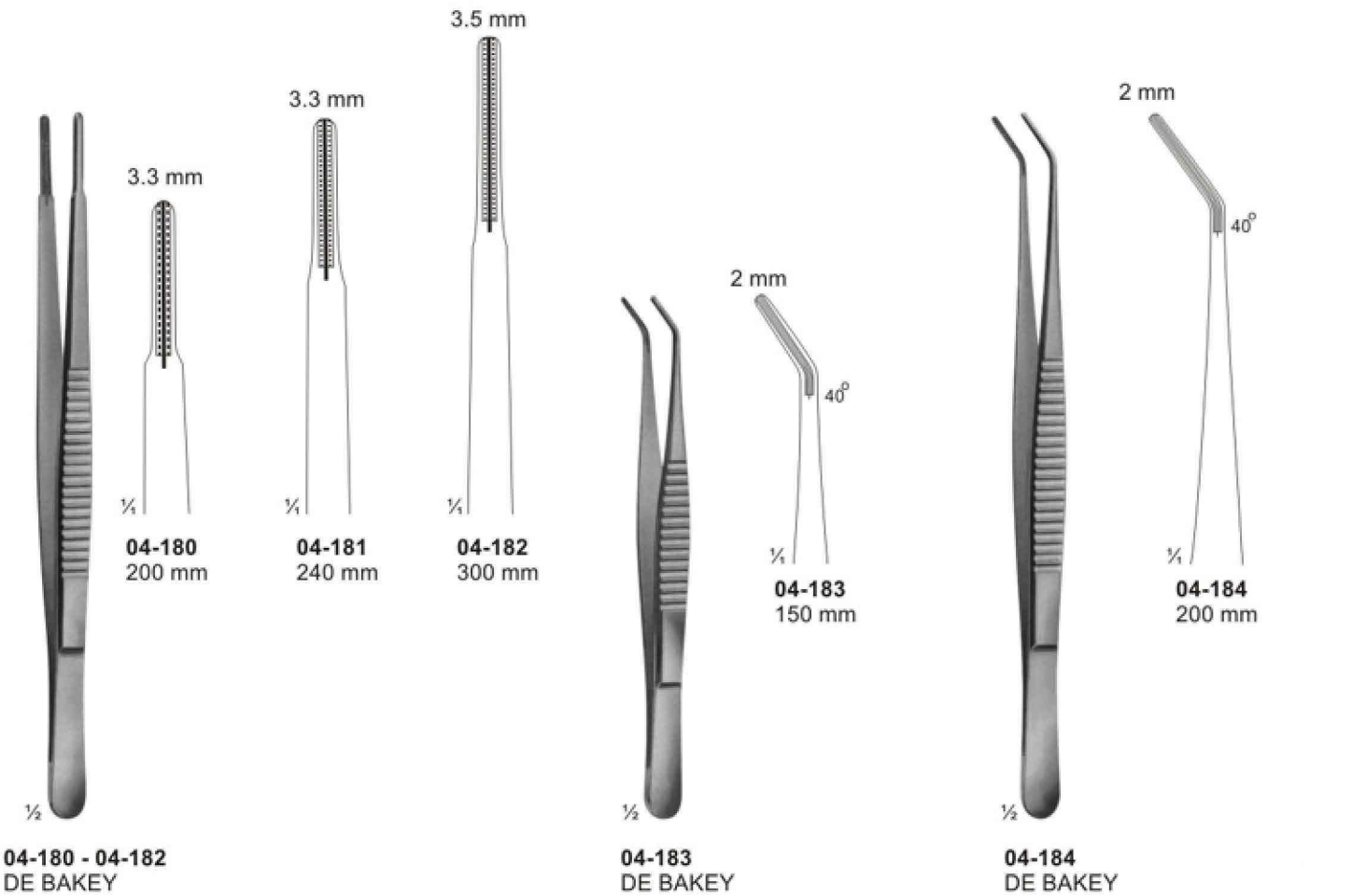
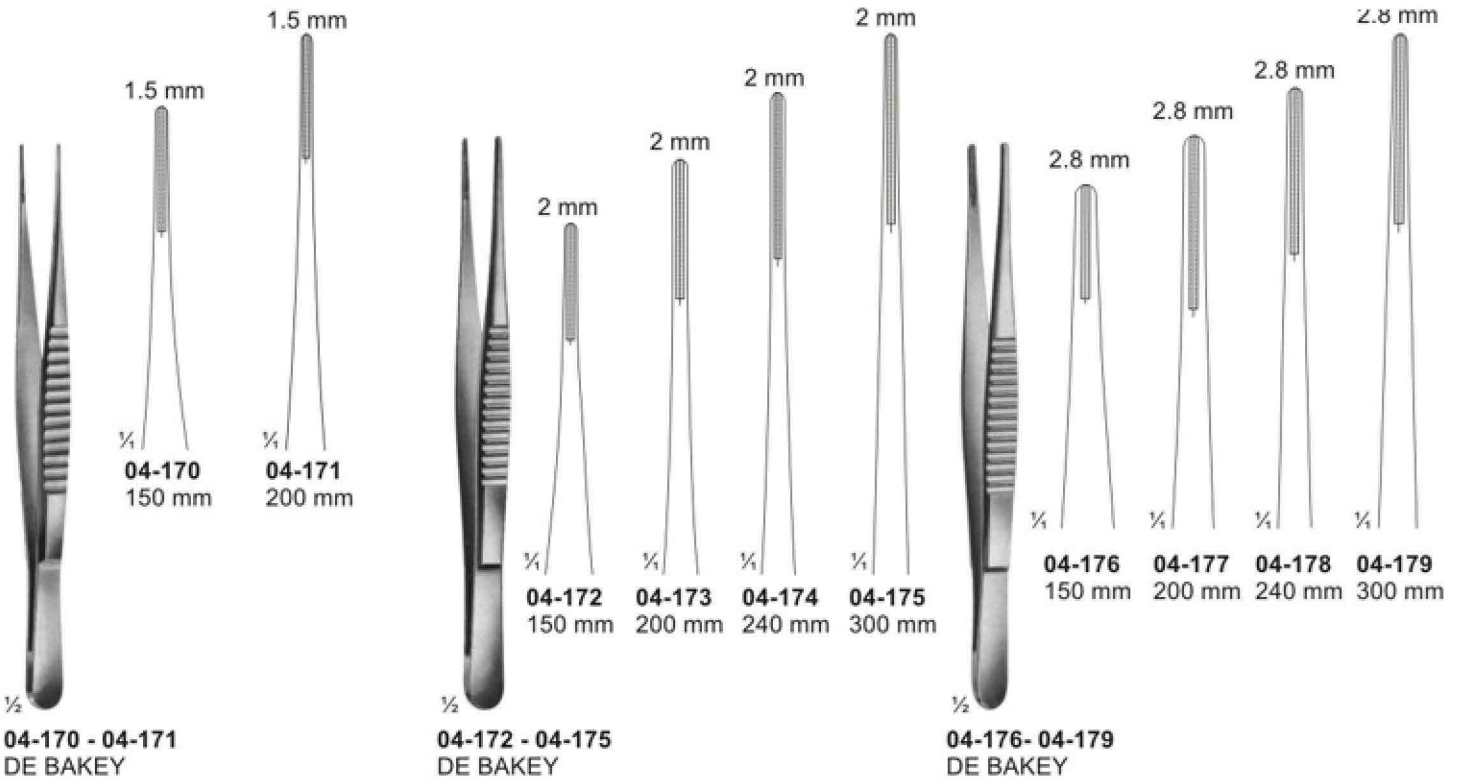

Delicate Tissue Forceps



04-185
BISHOP-HARMON
85 mm

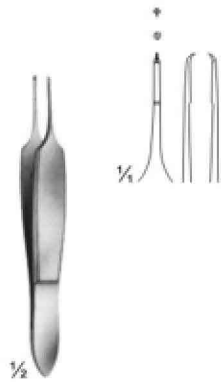

04-186
ST. MARTIN
80 mm

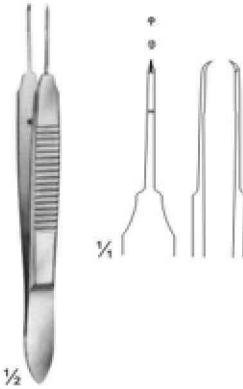

04-187
CASTROVIEJO
teeth 0.9 mm
100 mm

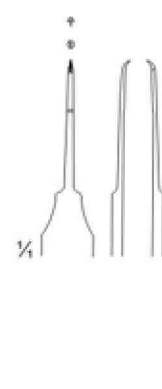

04-188
CASTROVIEJO
teeth 0.5 mm
100 mm

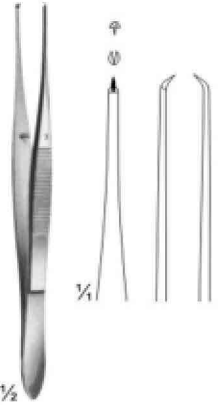

04-189
ELSCHING
110 mm

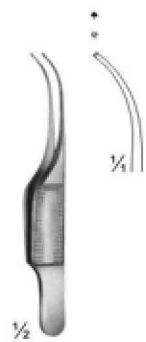

04-190
GILL
75 mm



04-191
GILL - HESS
75 mm

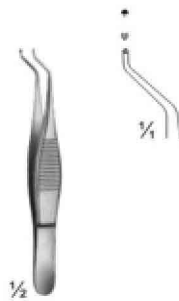

04-192
HESS
70 mm

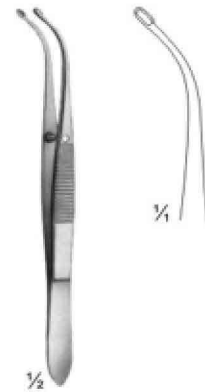

04-193
ARRUGA
100 mm

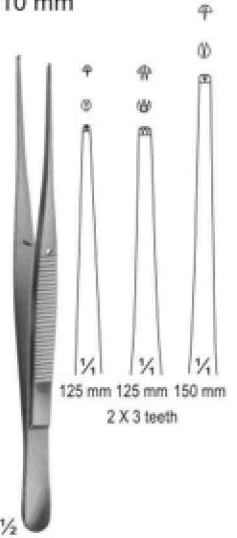

04-194
SEMKEN
125 mm
125 mm
150 mm
2 X 3 teeth

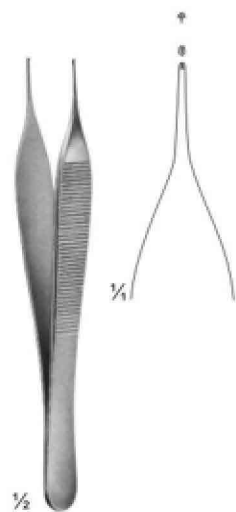

04-195
MICRO-ADSON
120 mm

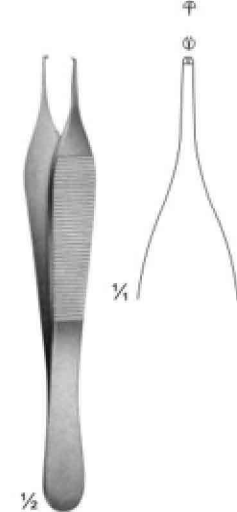

04-196
ADSON
120 mm



04-197
ADSON
120 mm

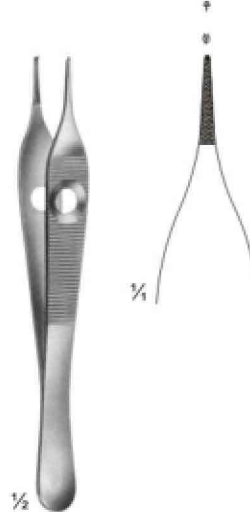

04-198
ADSON
120 mm



04-199
ADSON
150 mm

Tissue Forceps

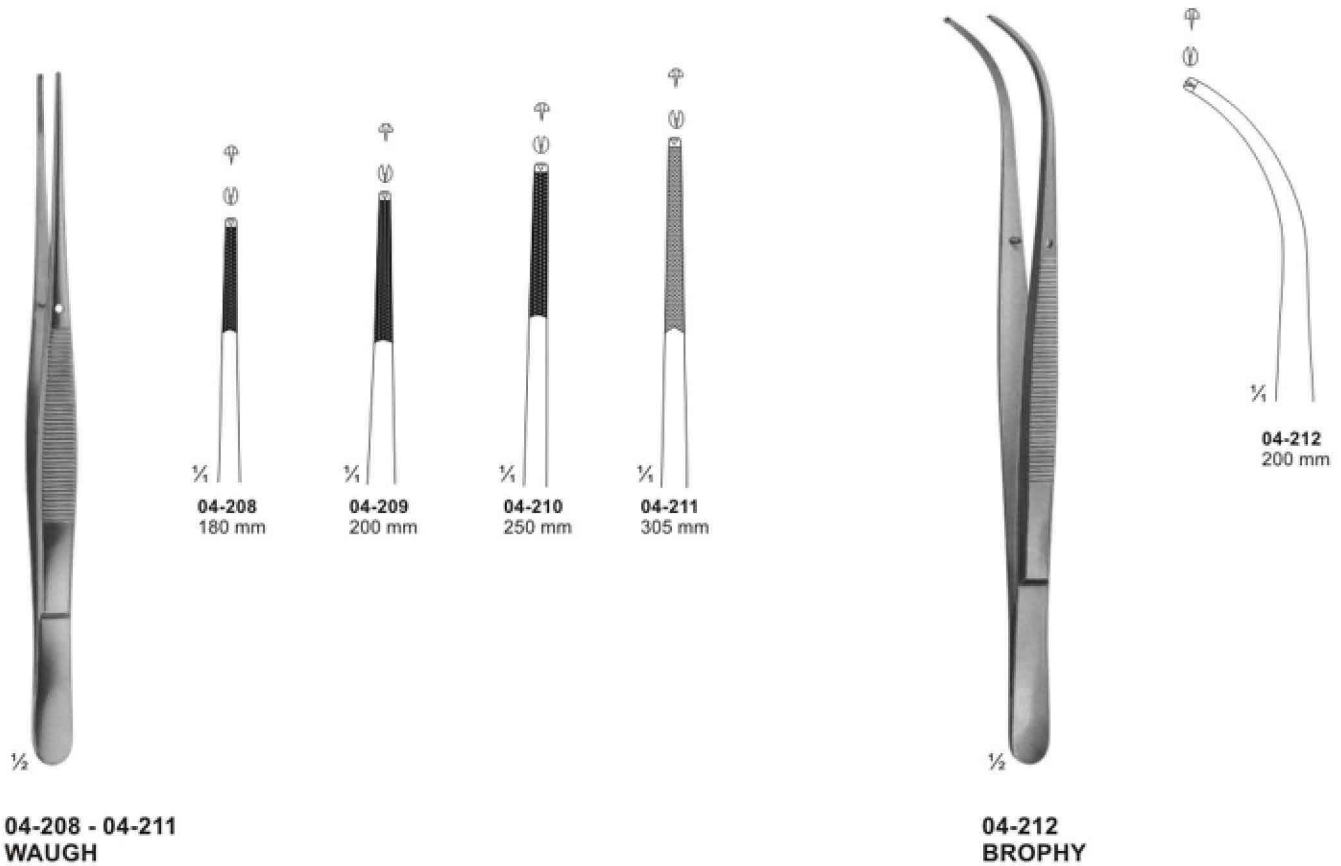
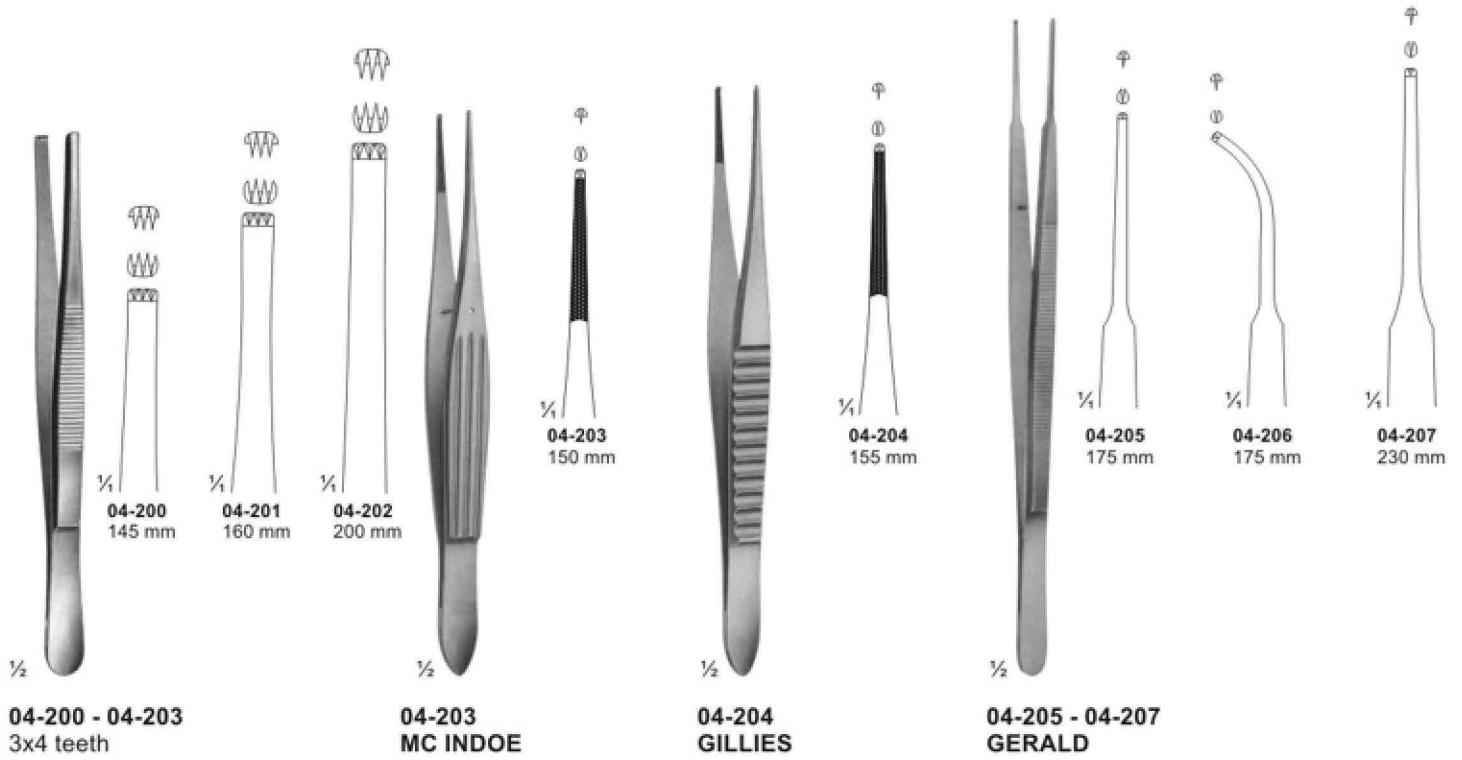

Tissue Forceps

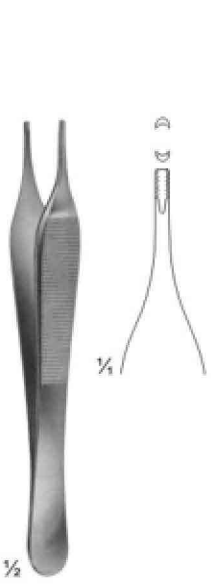

04-213
ADSON - BROWN
Non-traumatic
120 mm

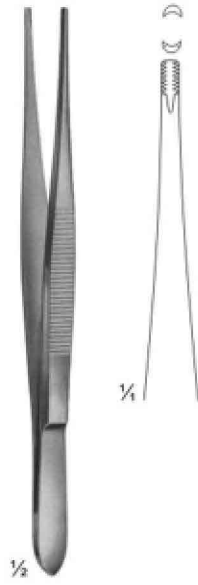

04-214
BROWN
120 mm



04-215
GRAEFE
110 mm



04-216
GRAEFE
With Catch
110 mm

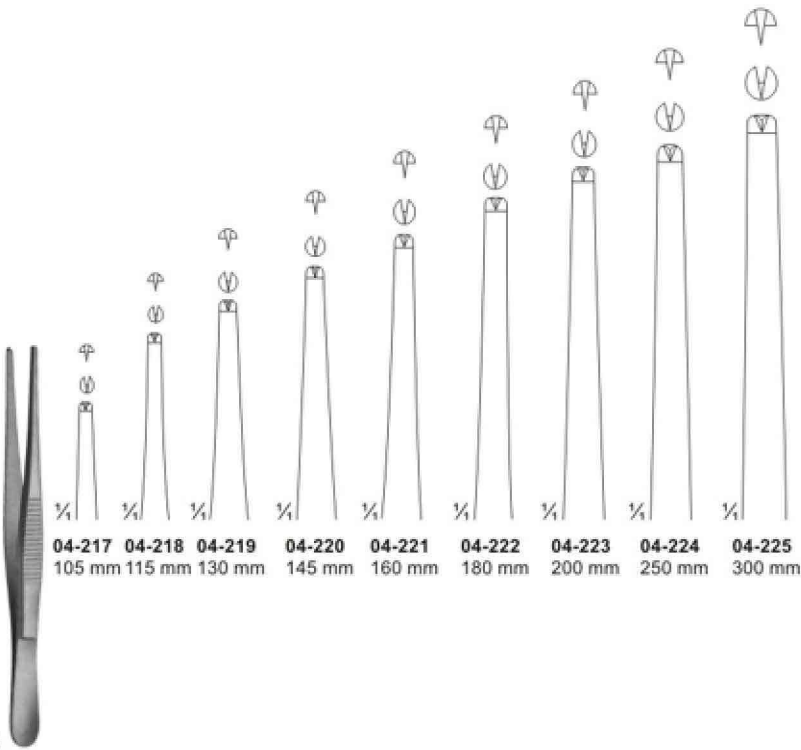

04-217 - 04-225
STANDARD

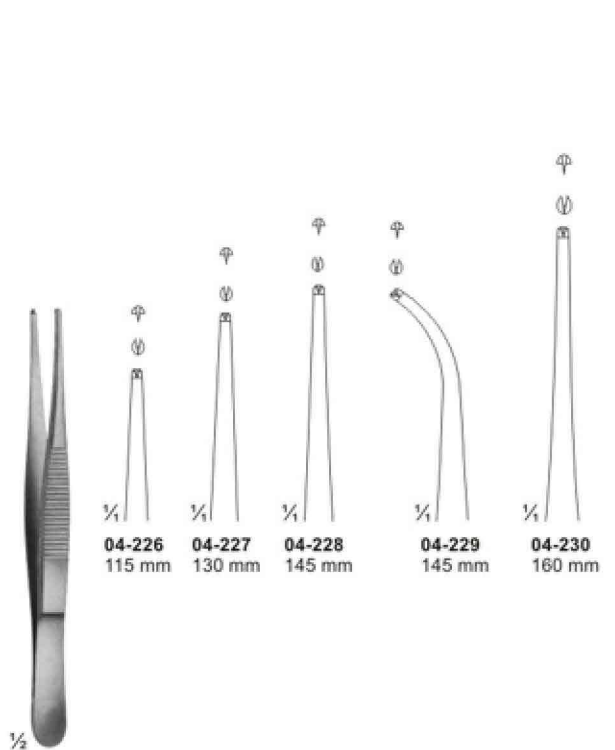

04-226 - 04-230
GRAEFE
110 mm

Forceps, Bayonet - Shaped

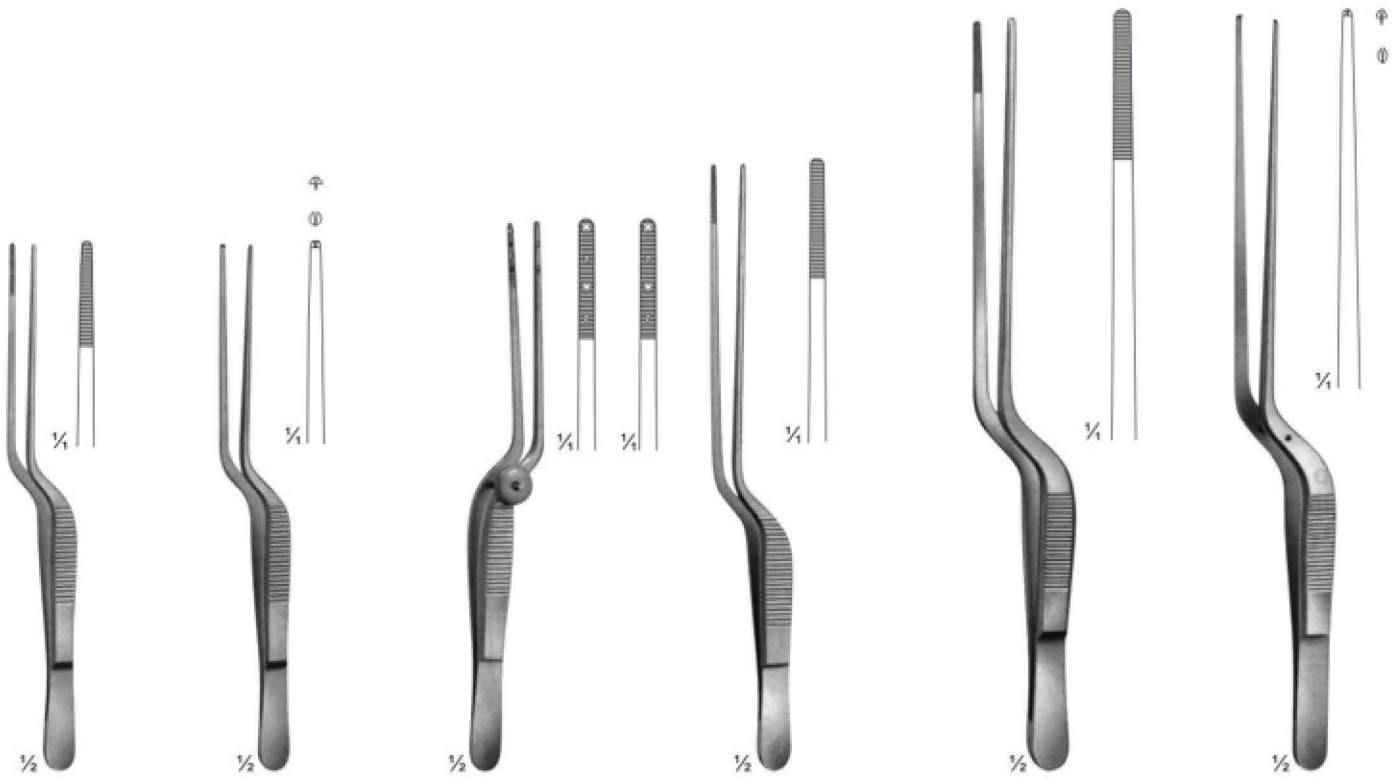

04-231
LUCAE
140 mm

04-232
LUCAE
1x2 teeth
140 mm

04-233
COTTLE
Forceps with
jaws toothed
and serrated
140 mm

04-234
JANSEN
160 mm

04-235
GRUENWALD
200 mm

04-236
1x2 teeth
200 mm

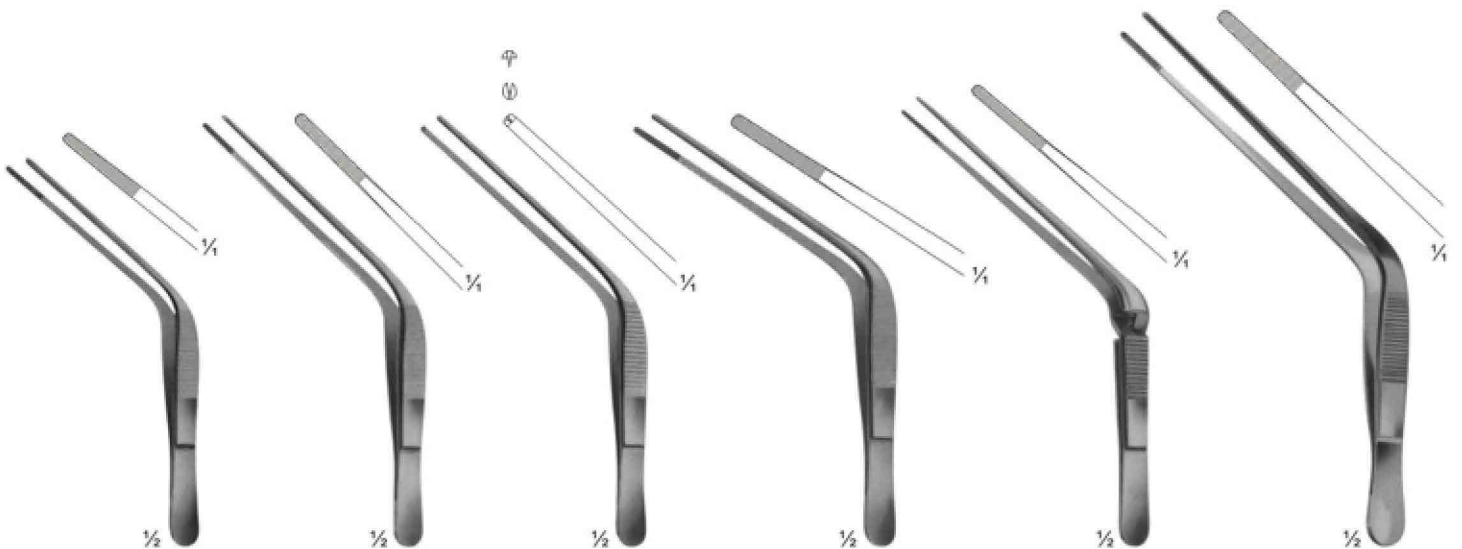

04-237
TROELTSCH
100 mm

04-238
TROELTSCH
115 mm

04-239
TROELTSCH
1X2 teeth
115 mm

04-240
WILDE
115 mm

04-241
TROELTSCH
Cross action
120 mm

04-242
TROELTSCH
140 mm

Tissue Forceps, Lung Dissecting Forceps



Splinter and Cilia Forceps

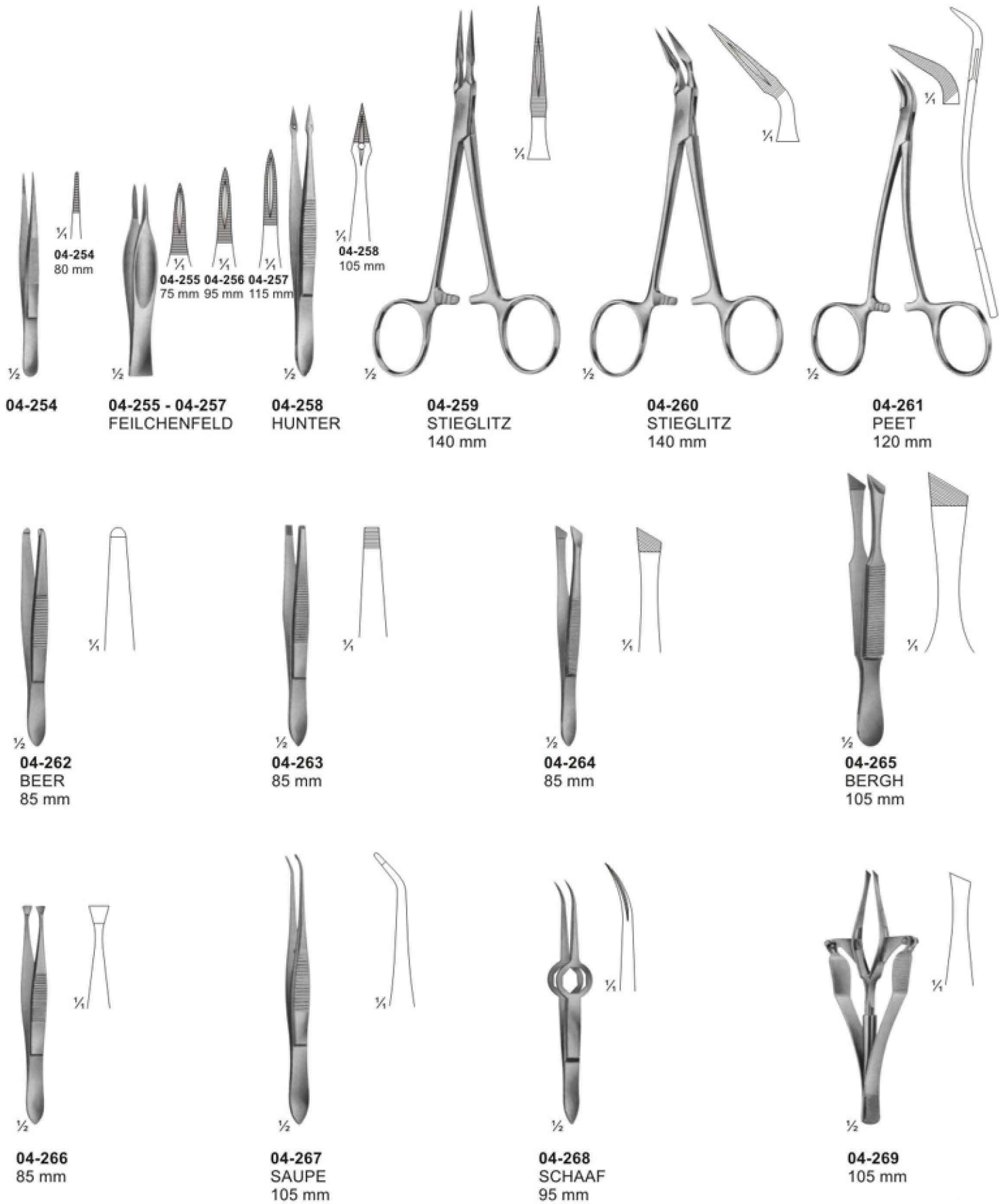

Sponge and Dressing Forceps

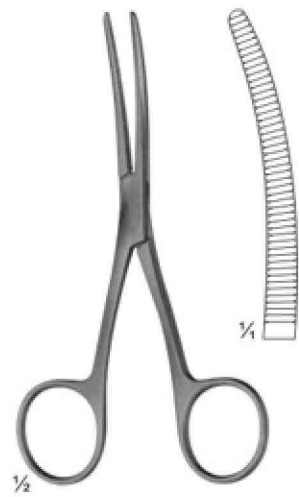
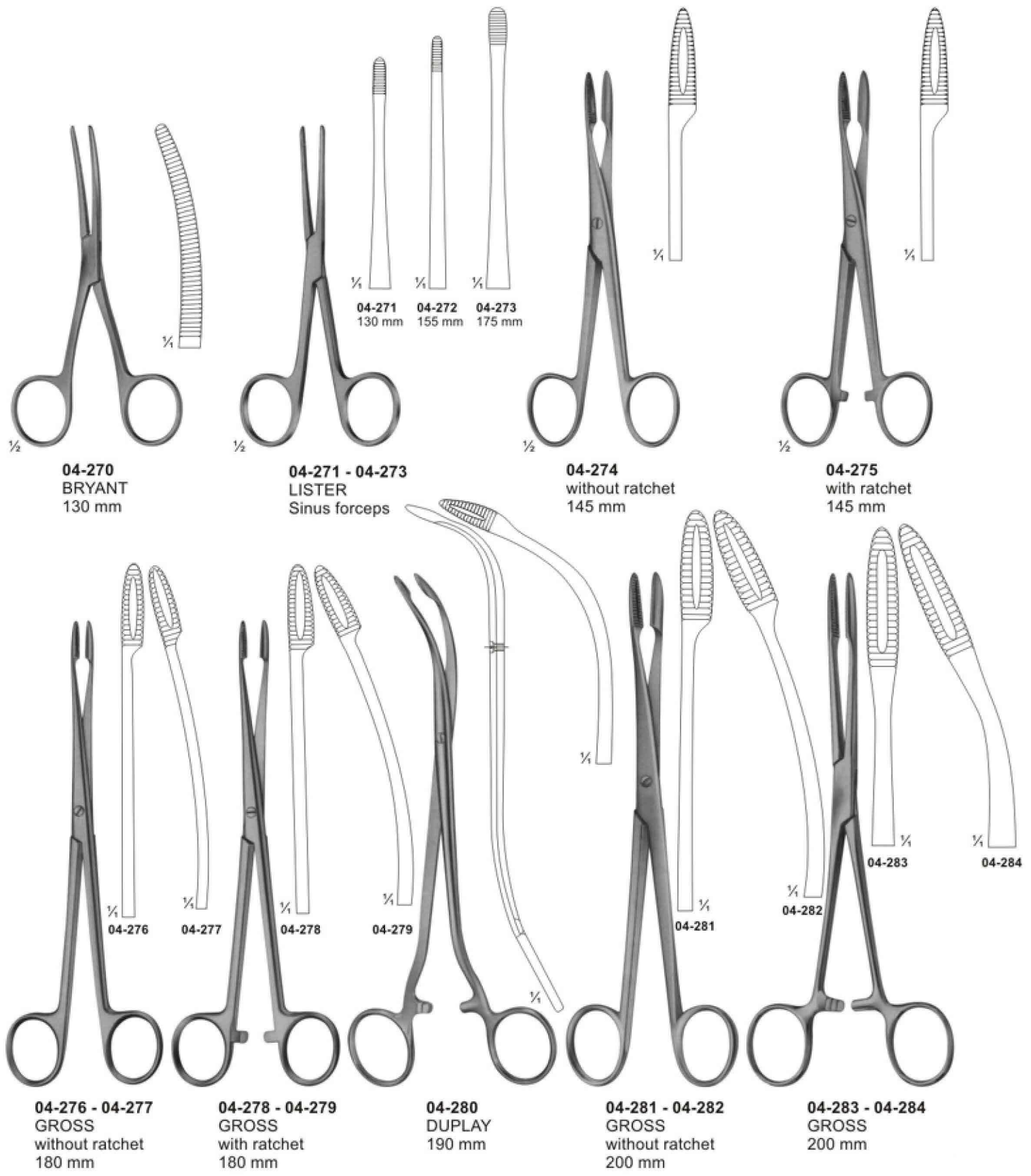

04-270
BRYANT
130 mm

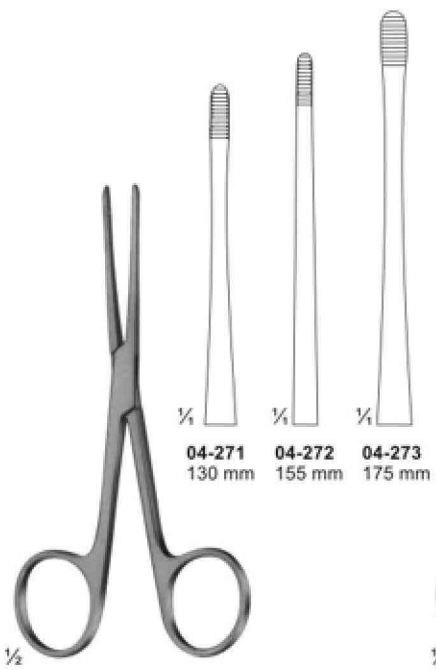

04-271 - 04-273
LISTER
Sinus forceps

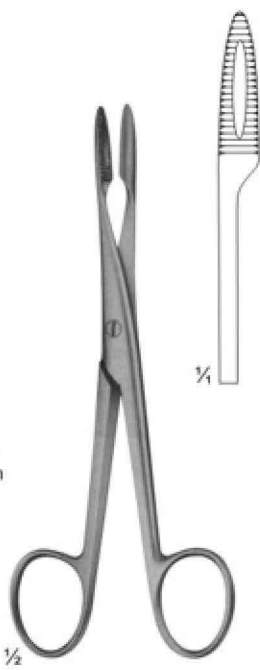

04-274
without ratchet
145 mm

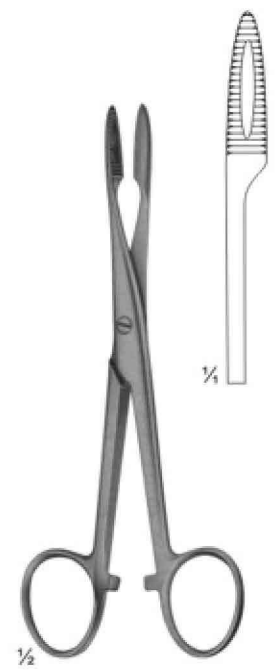

04-275
with ratchet
145 mm

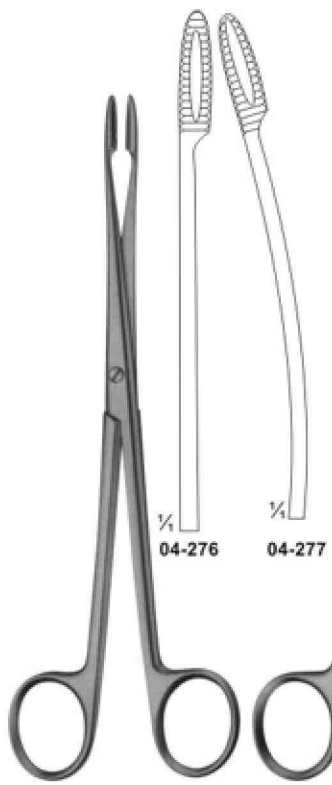

04-276 - 04-277
GROSS
without ratchet
180 mm

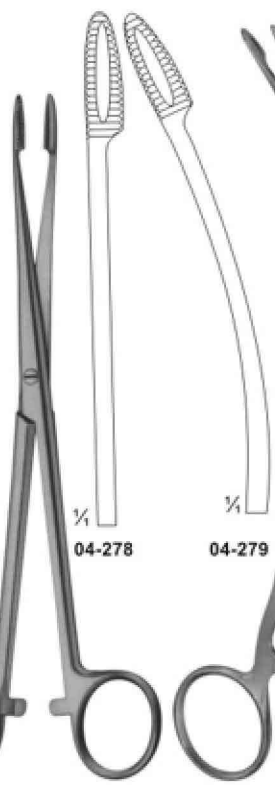

04-278 - 04-279
GROSS
with ratchet
180 mm

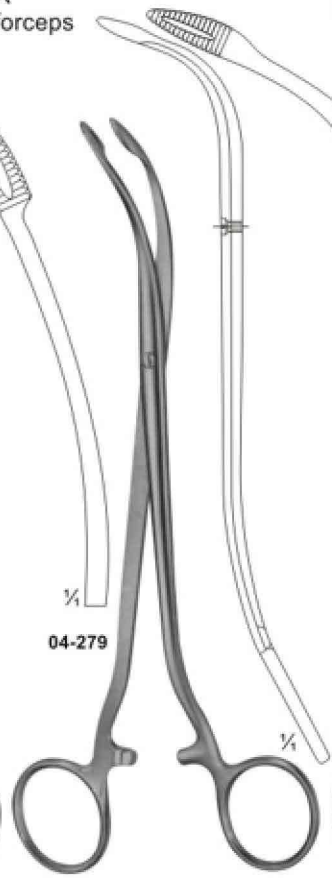

04-280
DUPLAY
190 mm

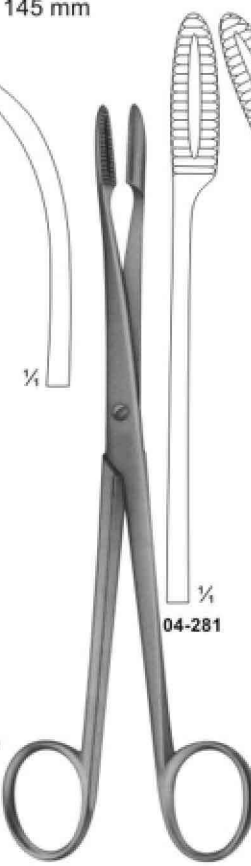

04-281 - 04-282
GROSS
without ratchet
200 mm

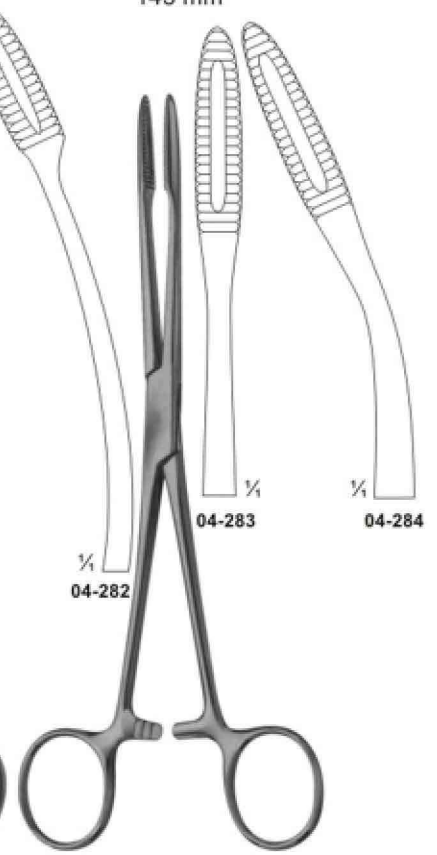

04-283 - 04-284
GROSS
200 mm

Dressing-, Sponge holding-, Organ- and Tissue Grasping Forceps

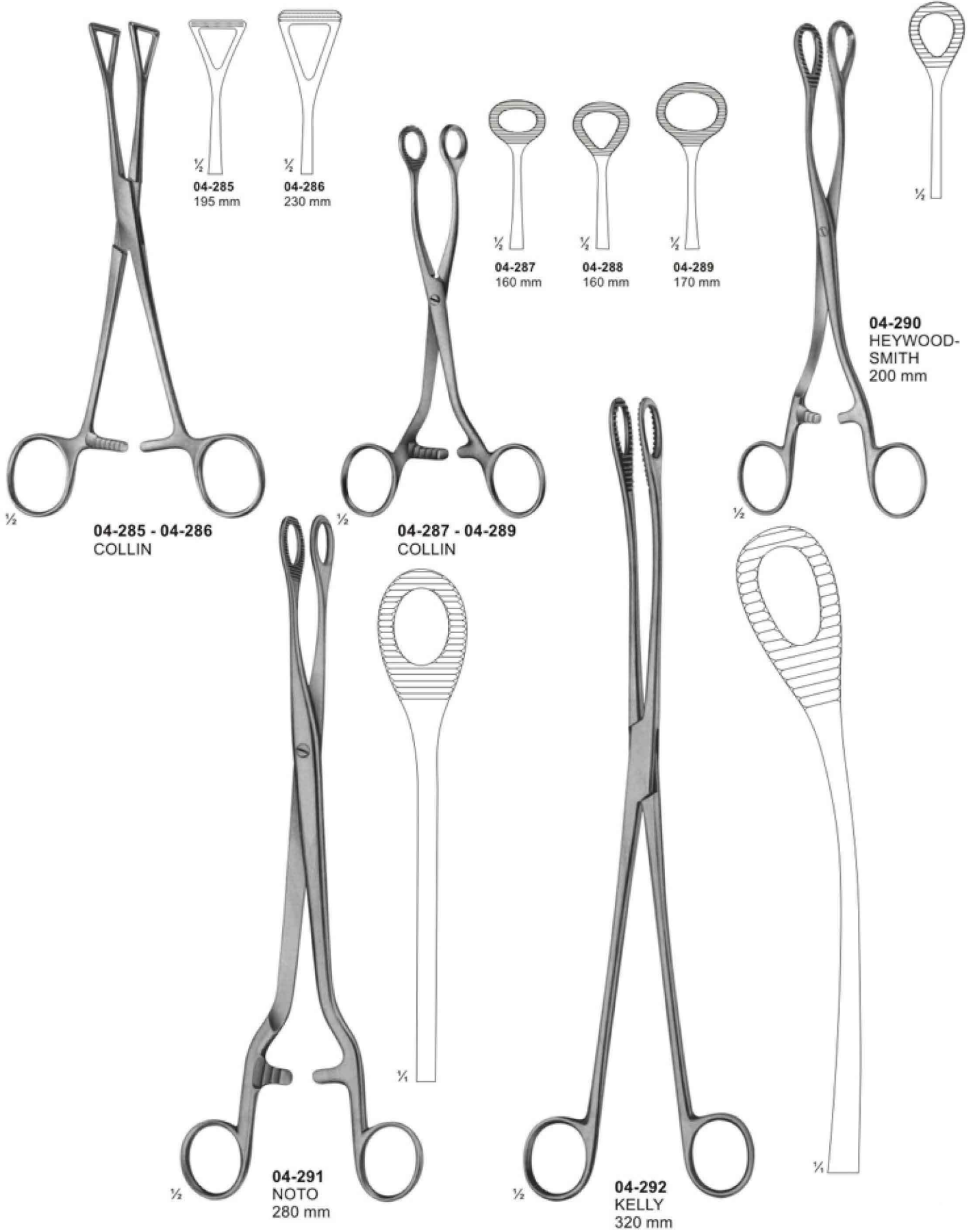

Dressing, Sponge holding, Organ and Tissue Grasping Forceps

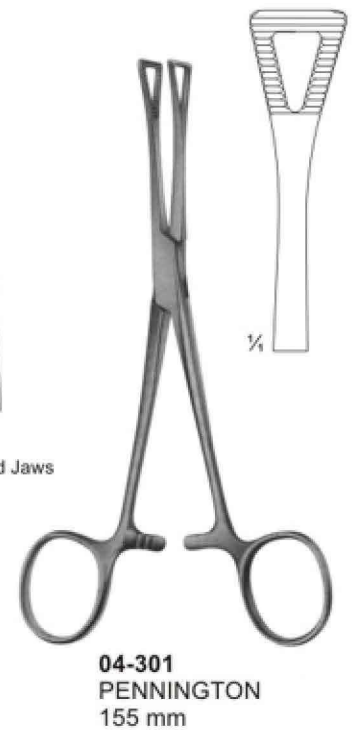
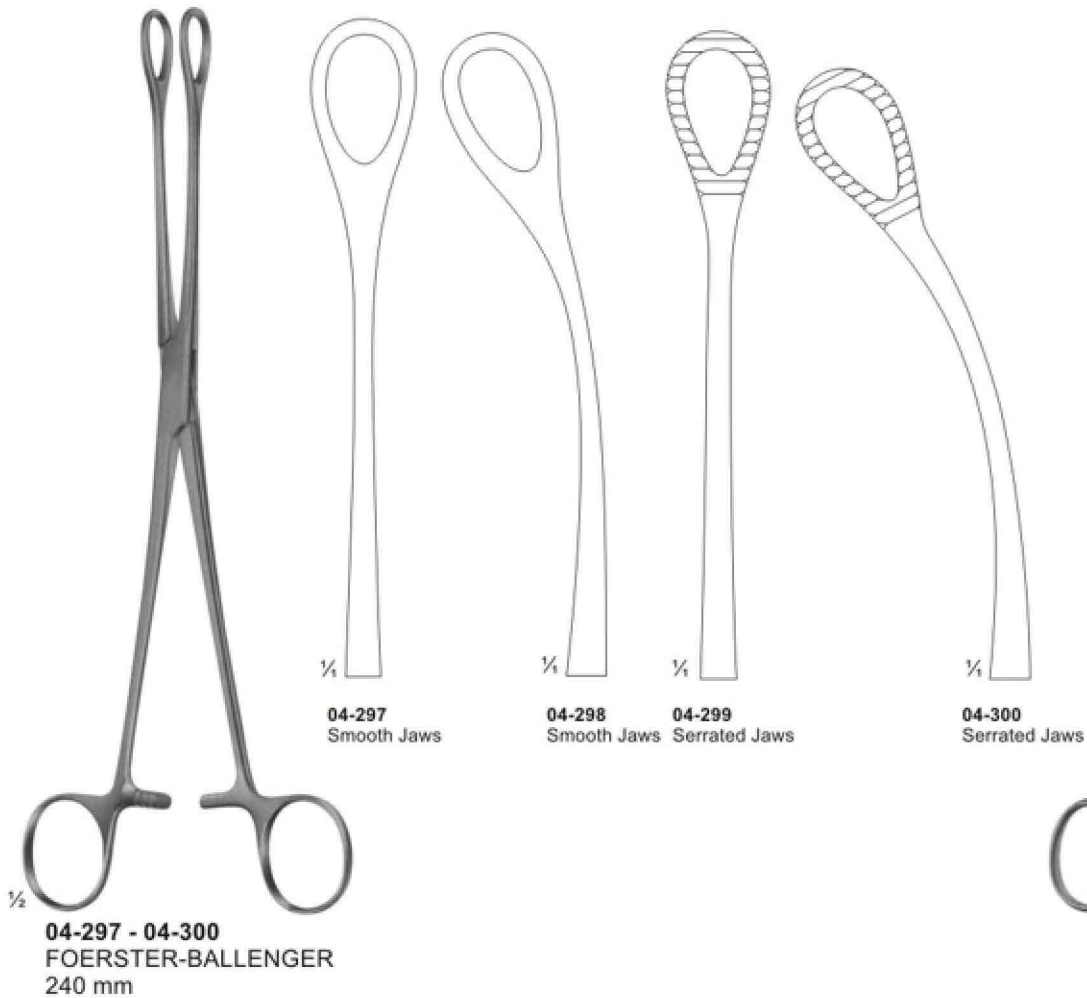
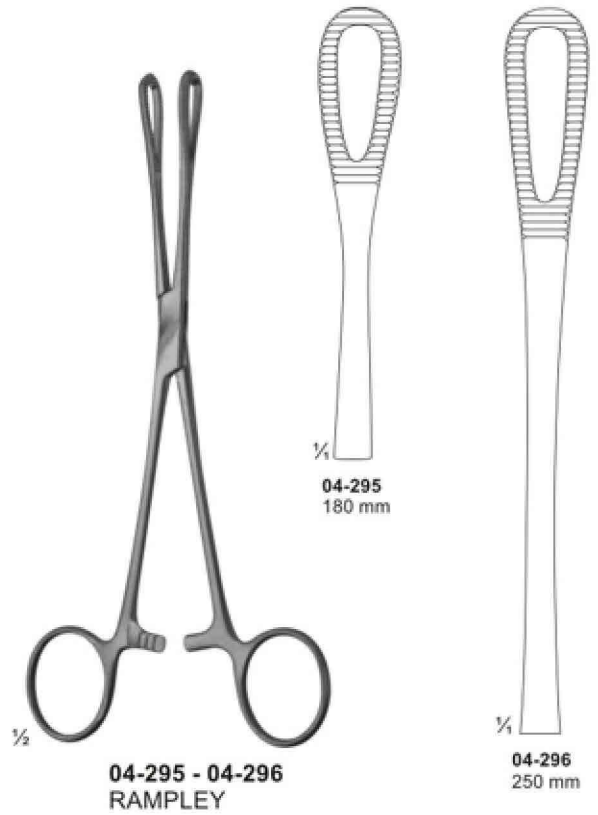
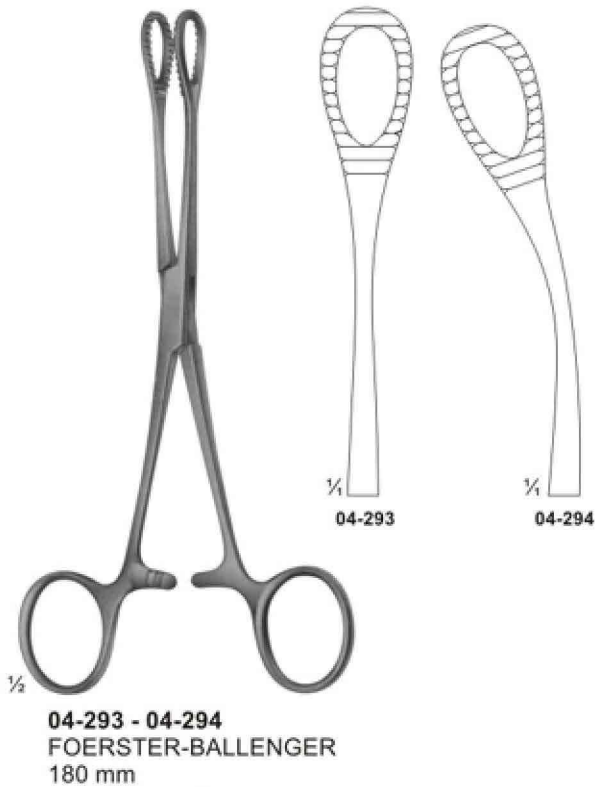

Intestinal Grasping Forceps

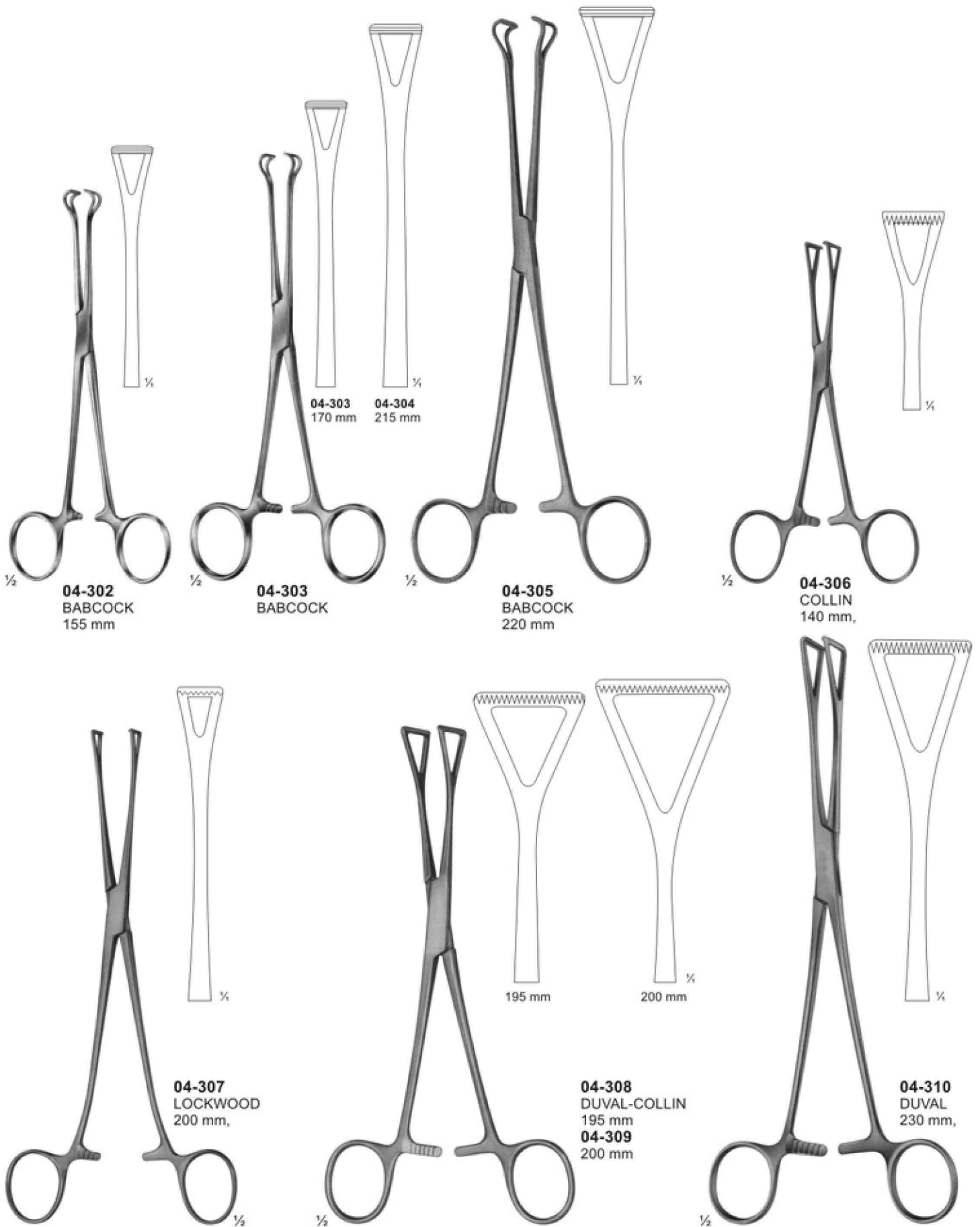

Artery Traction - and Tissue Grasping Forceps

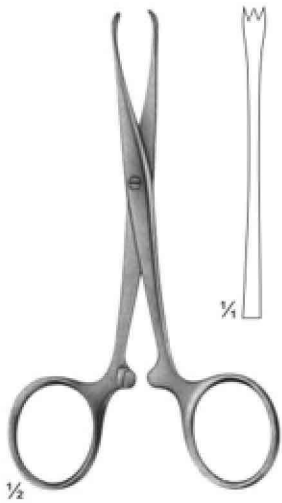

04-311
CHAPUT
2 x 3 teeth
125 mm

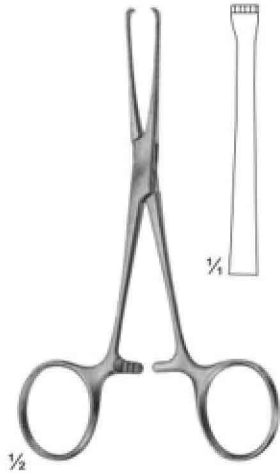

04-312
BABY-ALLIS
4 x 5 teeth
130 mm

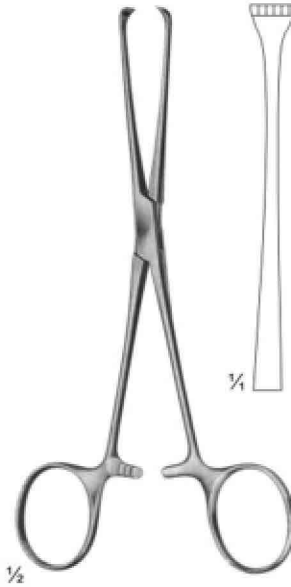

04-313
BOYS-ALLIS
5 x 6 teeth sharp
155 mm

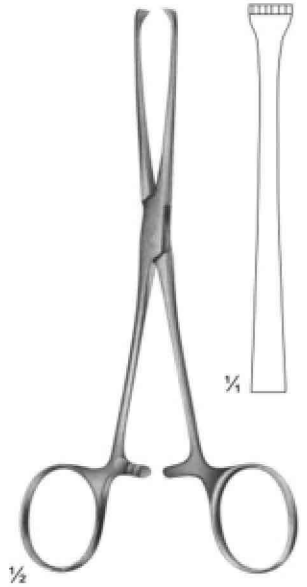

04-314
ALLIS
5 x 6 teeth
155 mm



04-315
LAHEY
155 mm

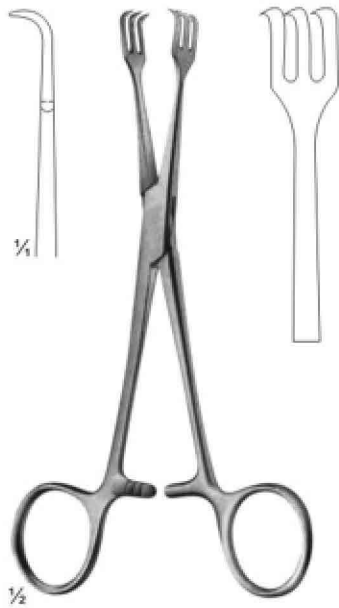

04-316
LAHEY
155 mm

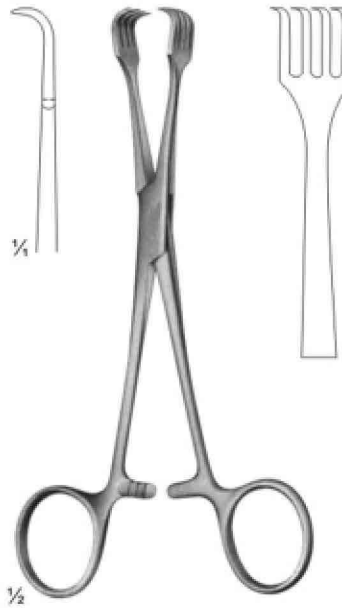

04-317
BRAUN
155 mm

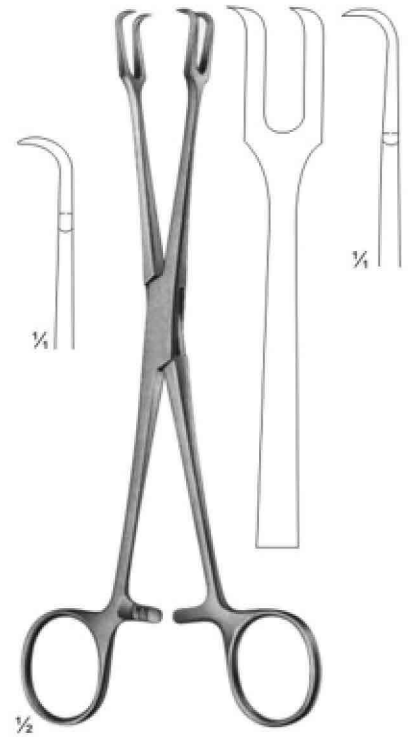





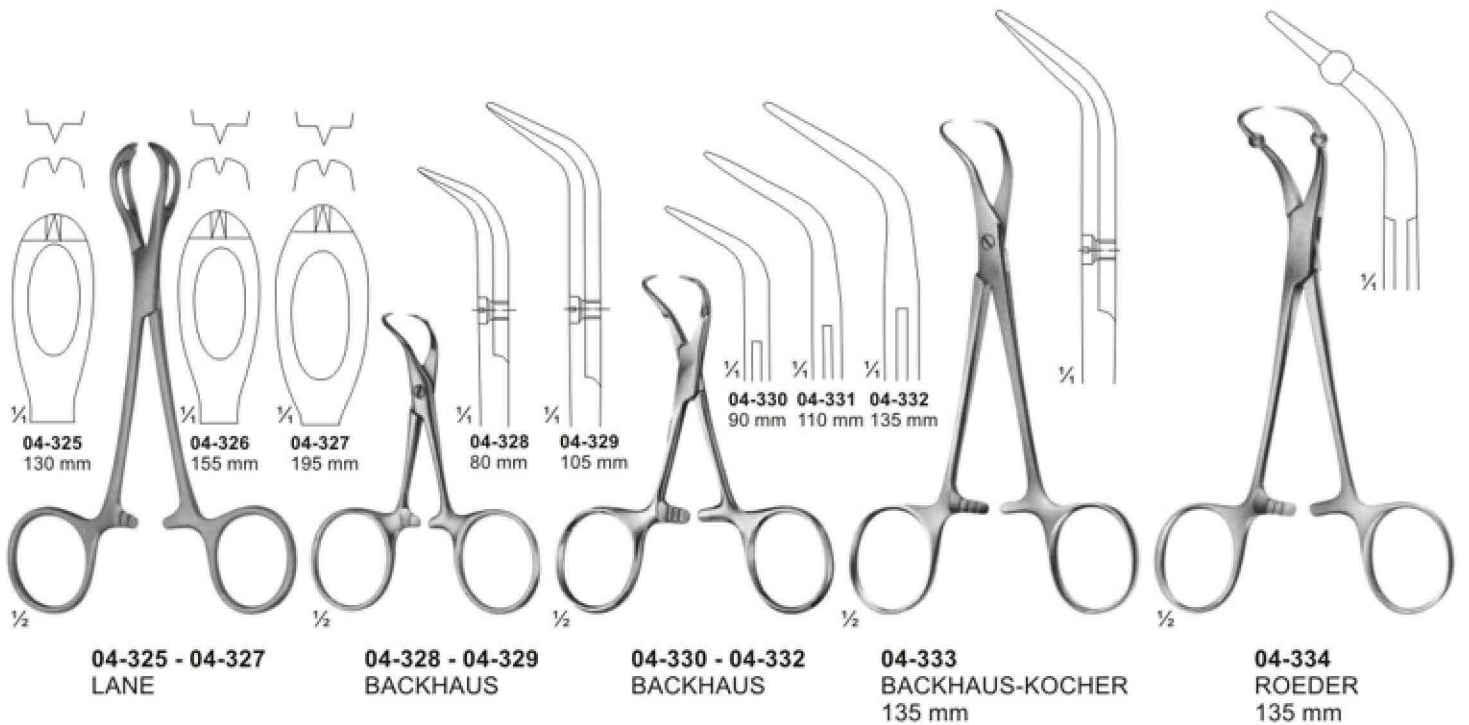
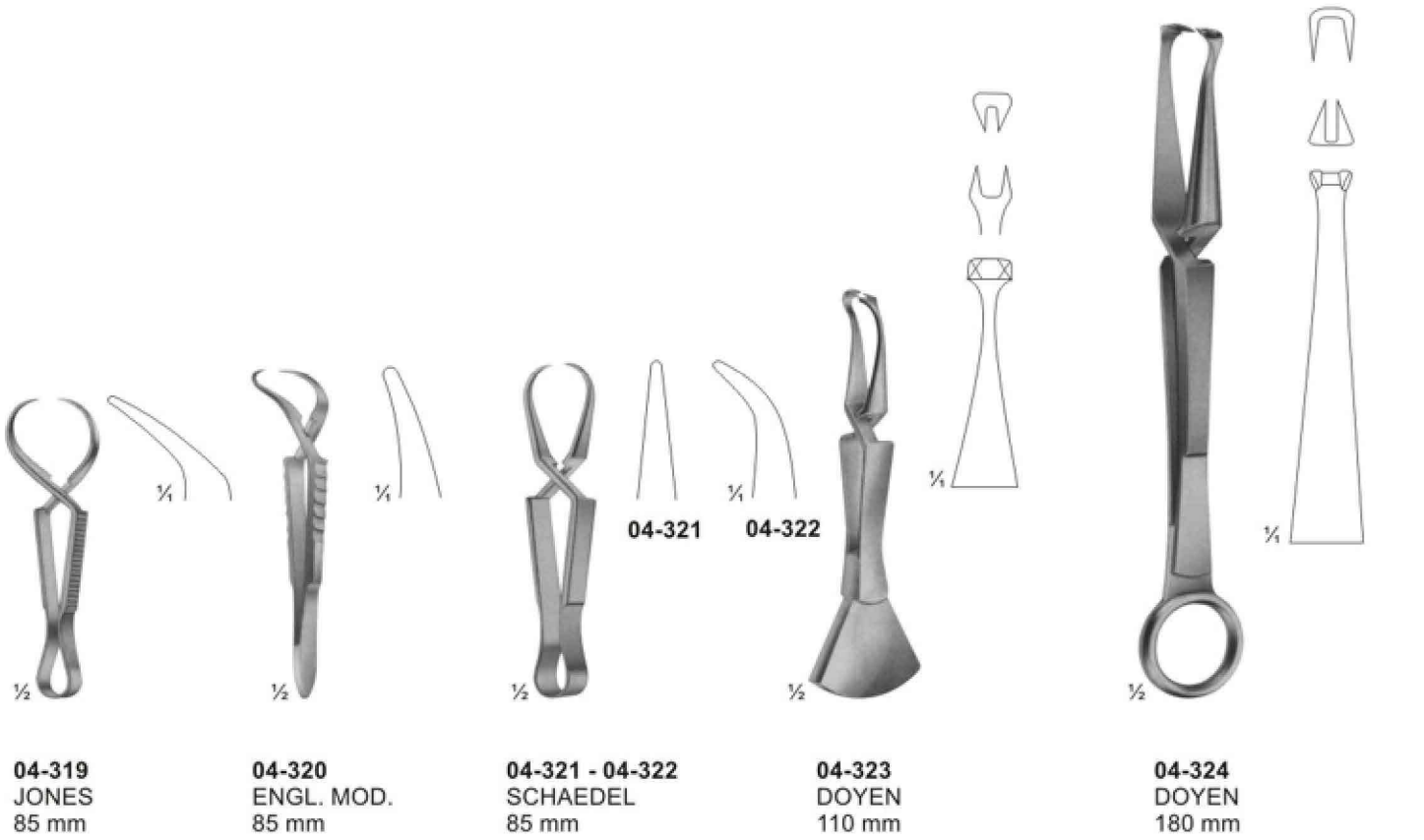























04-318
MUSEUX
200 mm

Towel Clamps



Muller Vessel Clips and Bulldog Clamps

Closing force

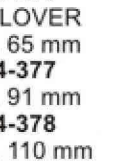
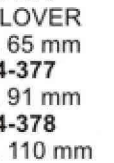
											
04-335 straight	04-336 curved	04-337 curved tips	04-338 angled shaped	04-339 MULLER knee-bent	04-340 Muller Ligature Forceps	Jaw, cross serrated					
80g 50g	80g 50g	80g 50g	80g 50g	80g 50g	80g 50g						
											
04-341 35 mm	04-342 35 mm	04-343 45 mm	04-344 45 mm	04-345 04-346 38 mm 48 mm	04-346 04-348 38 mm 48 mm	04-347 04-348 38 mm 48 mm	04-348 04-348 38 mm 48 mm	04-349 58 mm	04-350 58 mm	04-351 - 04-357 91 mm	04-358 DE BAKEY- HESS 20 mm
											
04-359 length 50 mm jaws 27 mm	04-360 length 48 mm jaws 27 mm	04-361 GLOVER length 57 mm jaws 35 mm	04-362 DE BAKEY length 73 mm jaws 38 mm	04-363 DE BAKEY length 99 mm jaws 63 mm	04-364 DE BAKEY length 95 mm jaws 54 mm	04-365 L. 80 mm 04-366 L. 90 mm 04-367 L. 105 mm 04-368 L. 124 mm	04-369 L. 78 mm 04-370 L. 86 mm 04-371 L. 97 mm 04-372 L. 114 mm	04-373 GLOVER L. 68 mm 04-374 L. 96 mm 04-375 L. 117 mm	04-376 GLOVER L. 65 mm 04-377 L. 91 mm 04-378 L. 110 mm		

Delicate Haemostatic Forceps

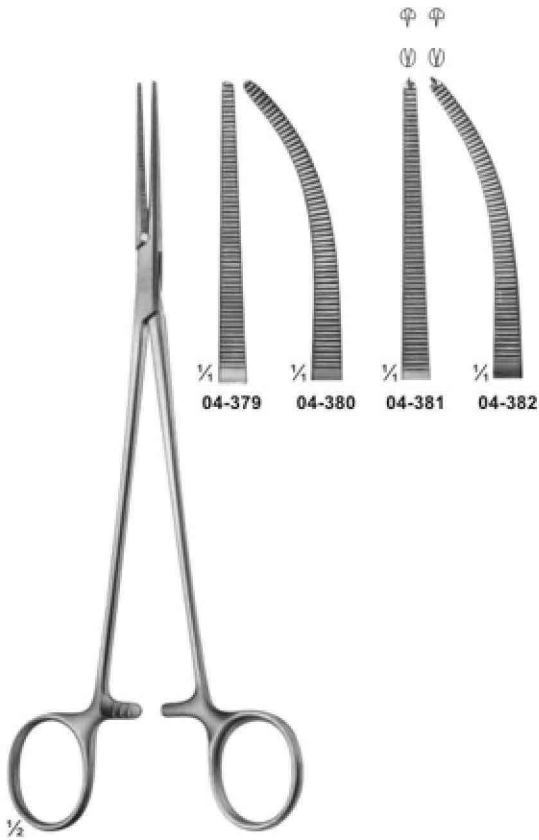

04-379 - 04-382
HALSTED-MOSQUITO
200 mm



04-383 - 04-387
HEISS
200 mm



04-388 - 04-389
HALSTED
215 mm

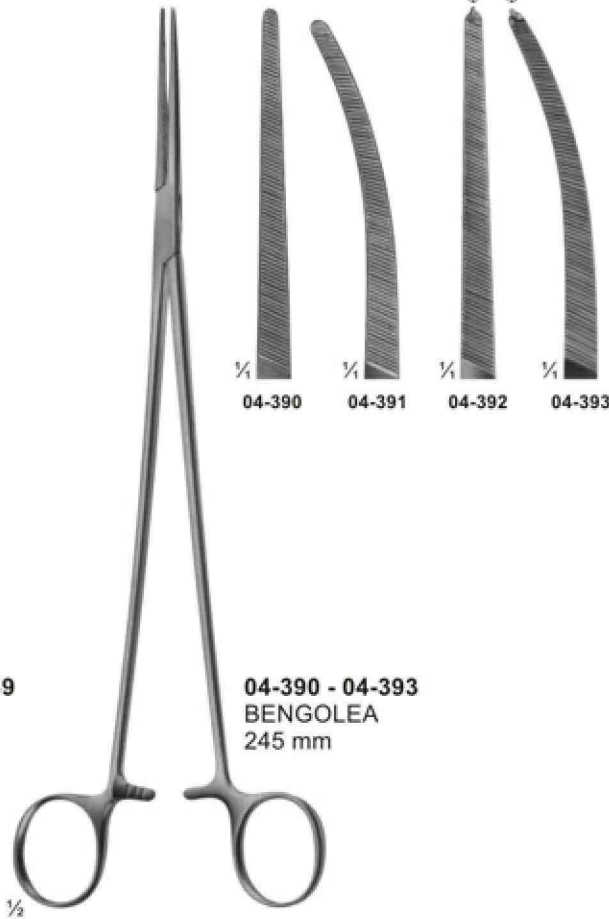

04-390 - 04-393
BENGOLEA
245 mm



04-394
CRAFOORD
245 mm

Delicate Haemostatic Forceps

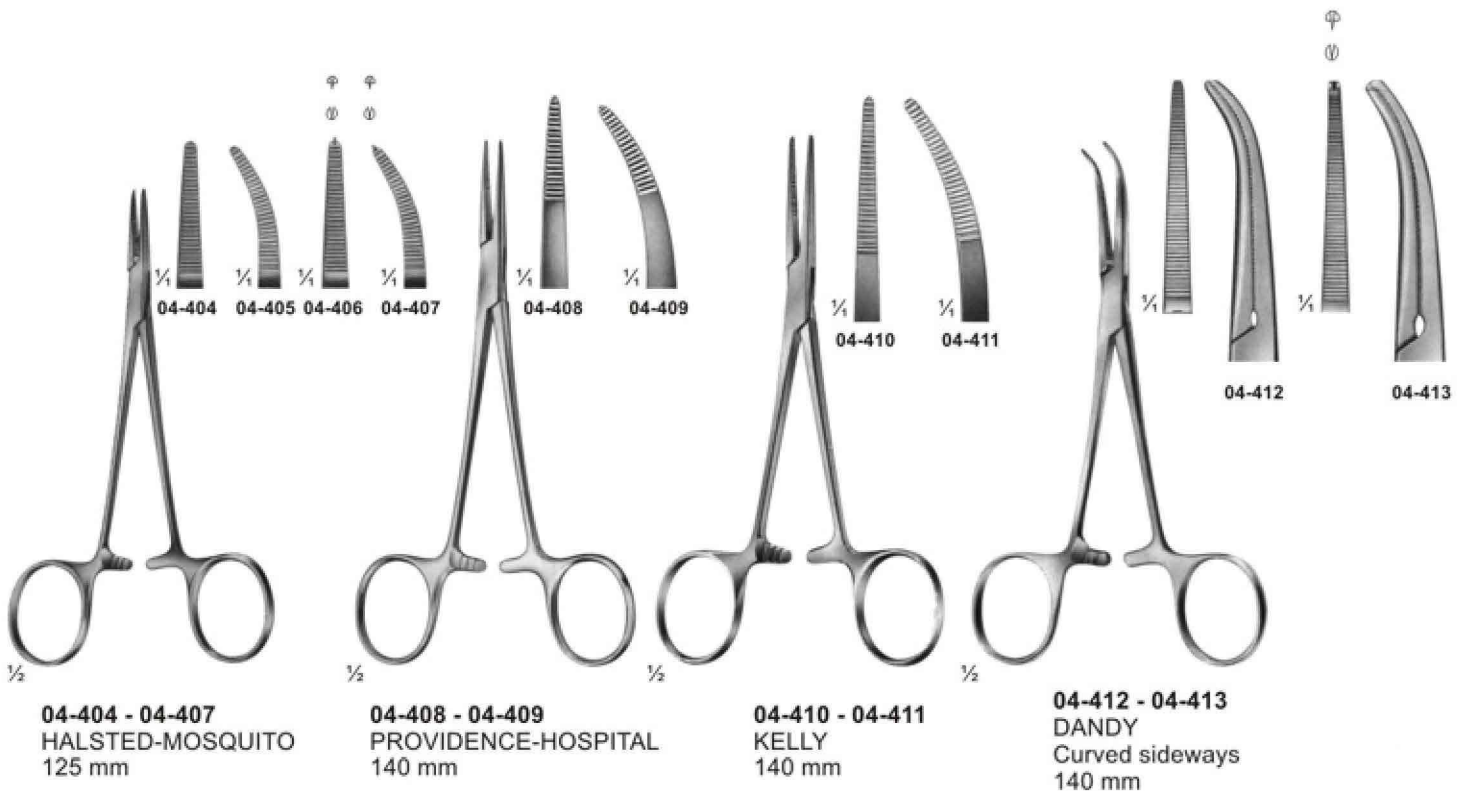
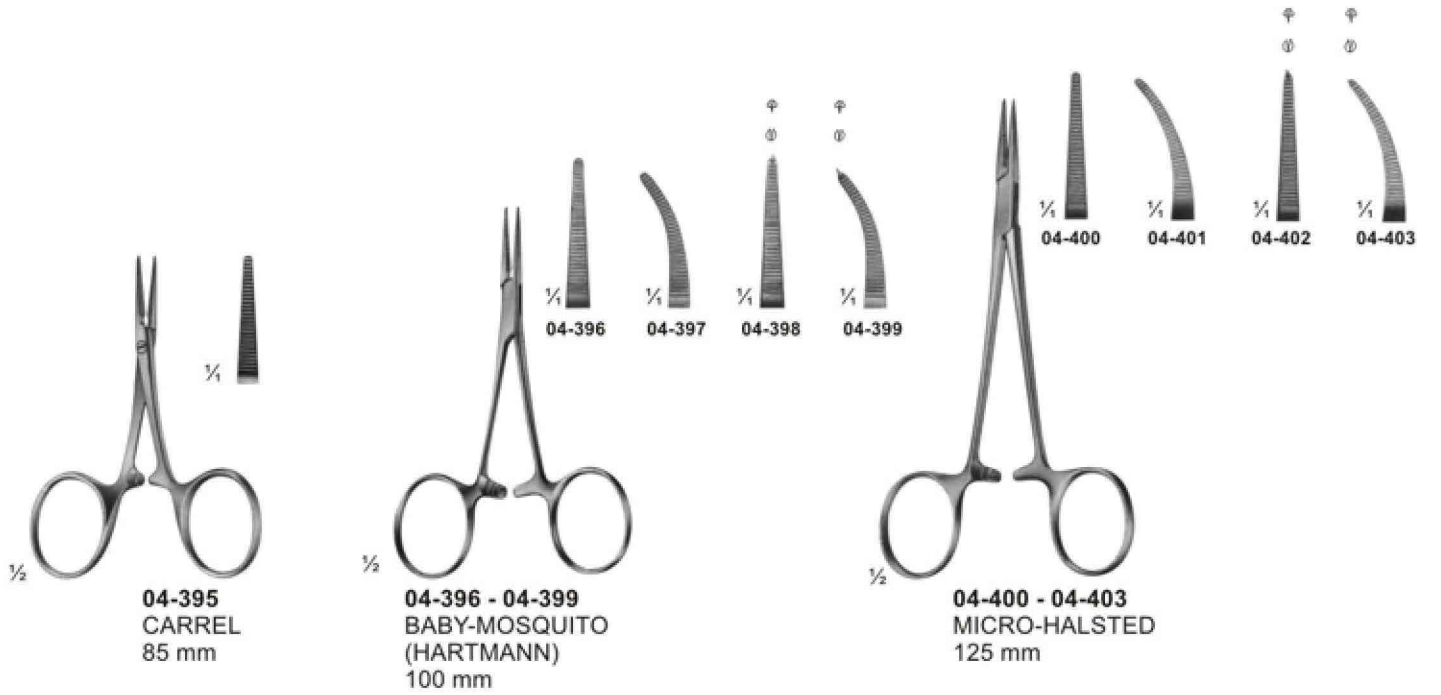

Delicate Haemostatic Forceps

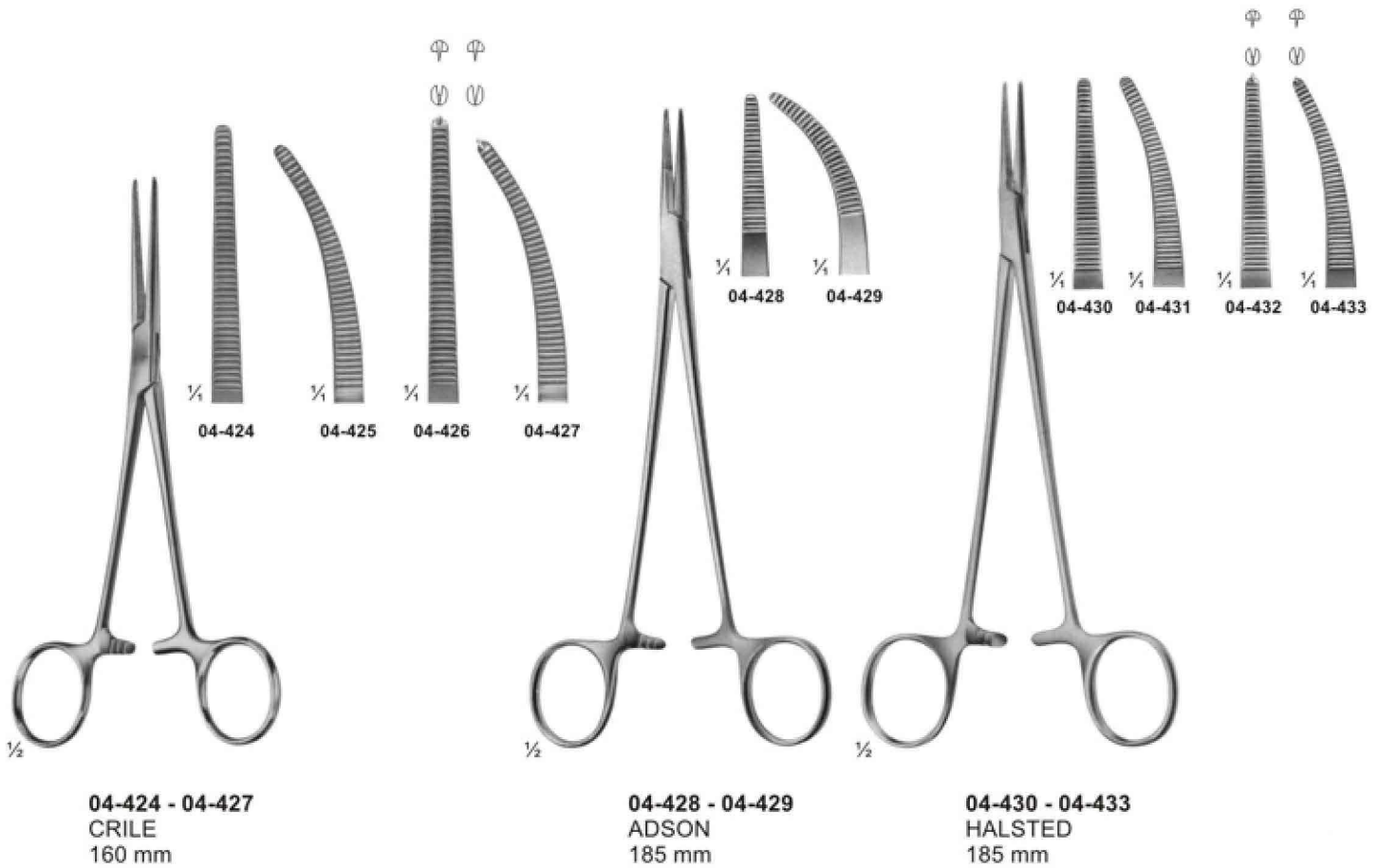
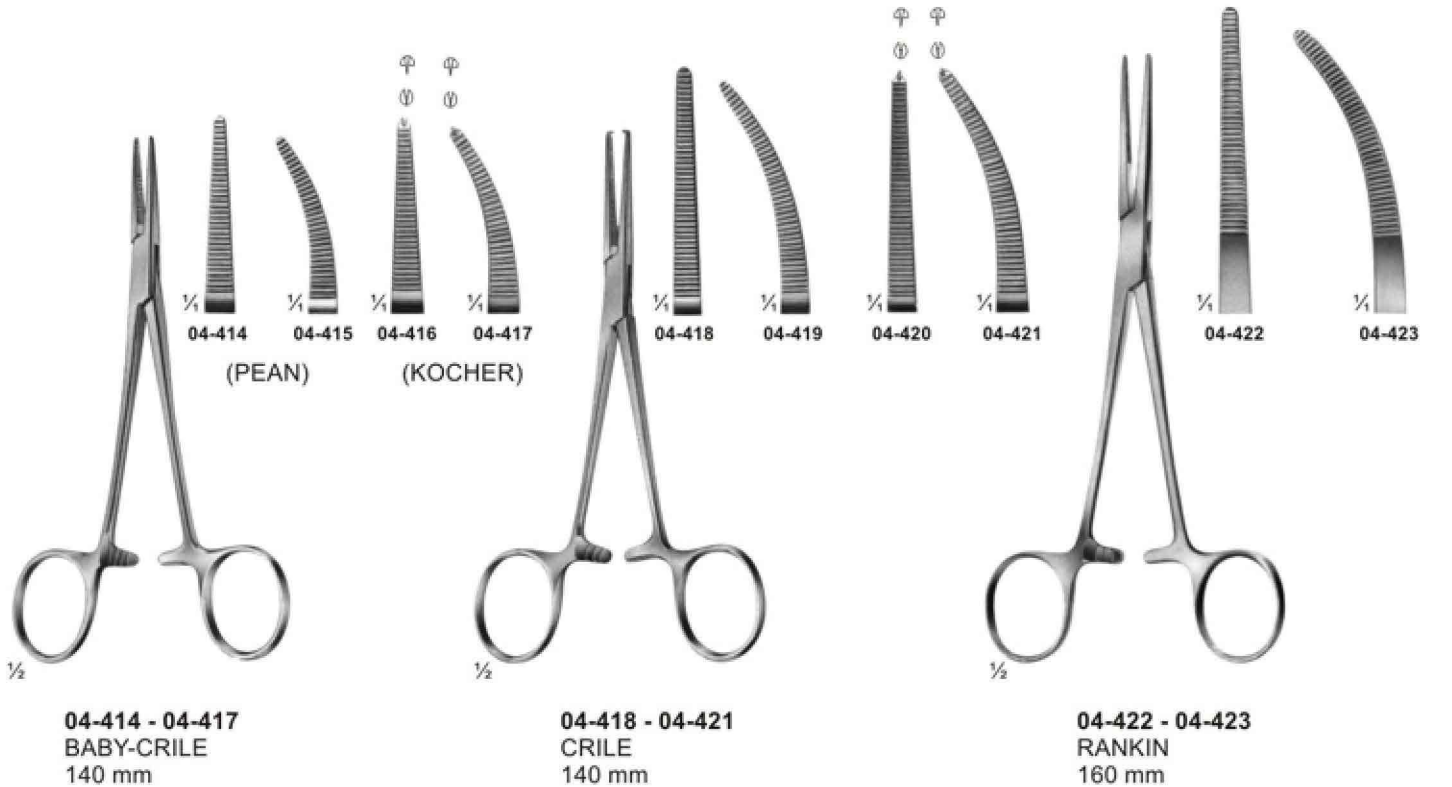

Haemostatic Forceps

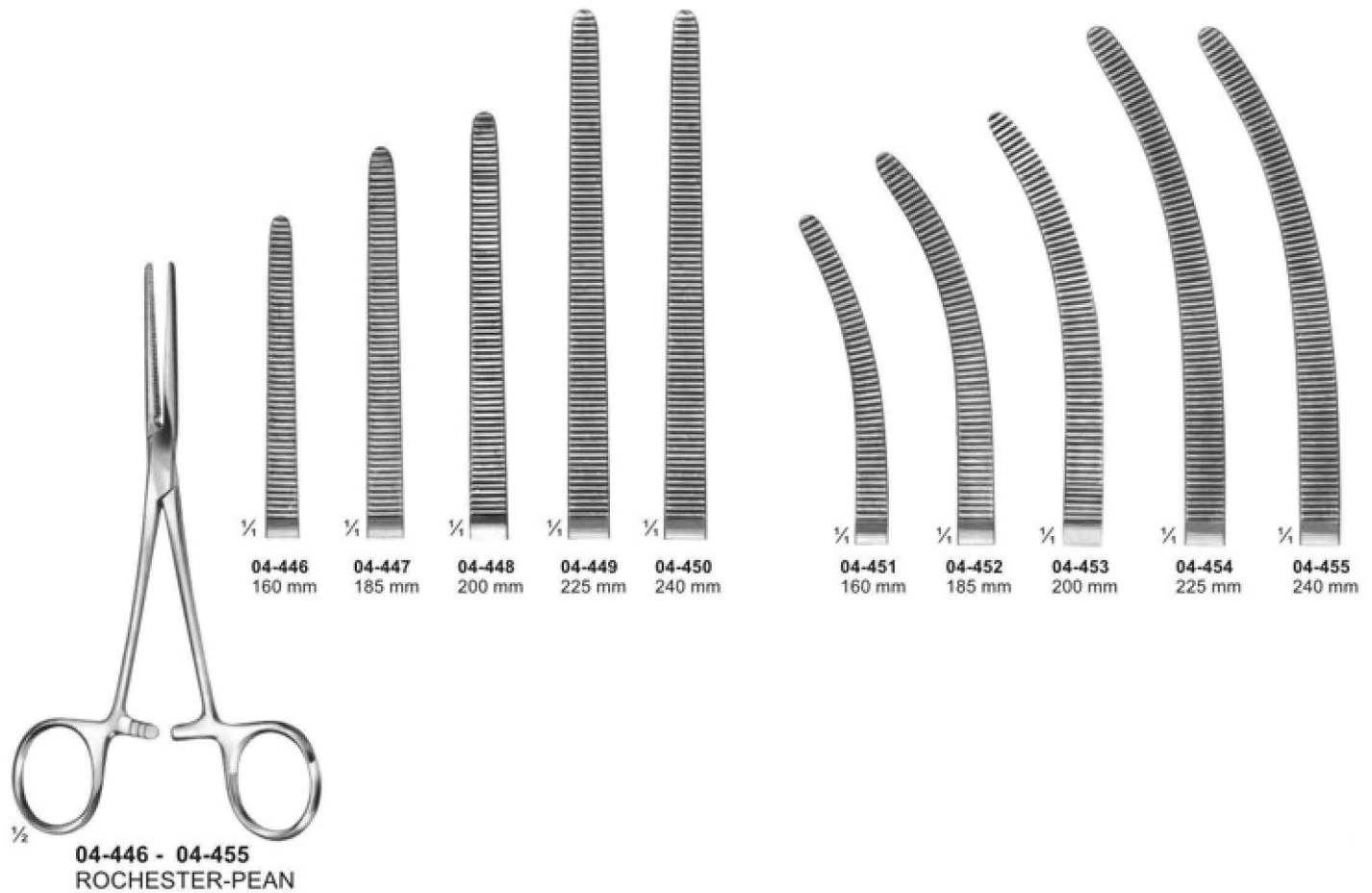
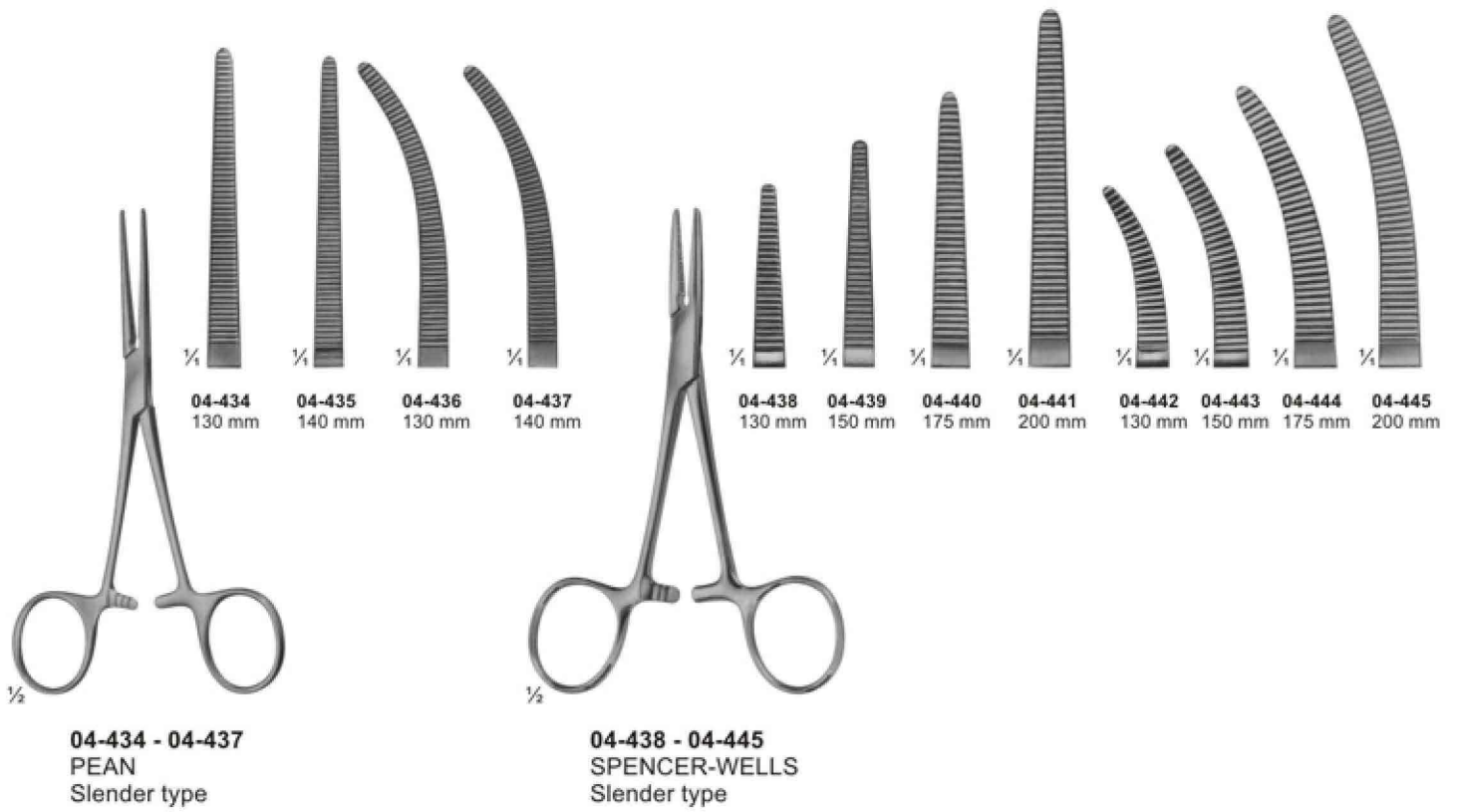

Haemostatic Forceps



04-456 - 04-461
PEAN

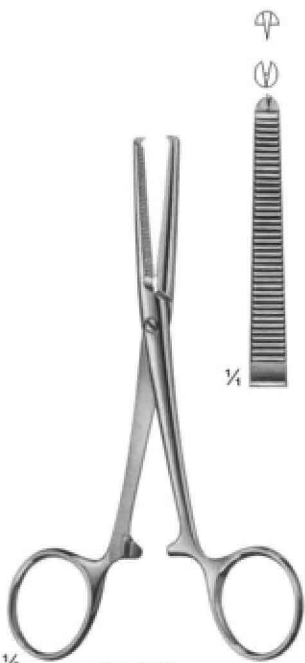
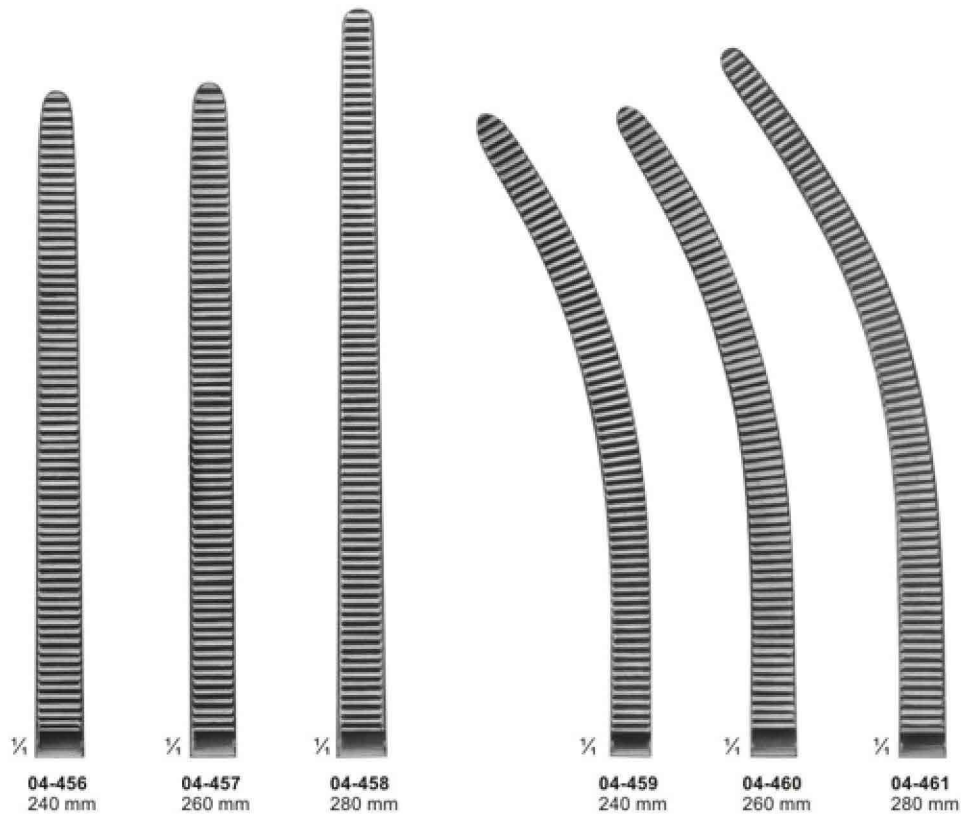

04-462
KOCHER
Strong Pattern
145 mm

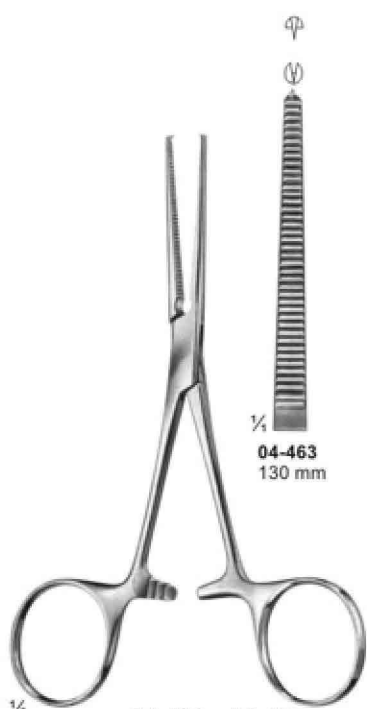

04-463 - 04-465
KOCHER

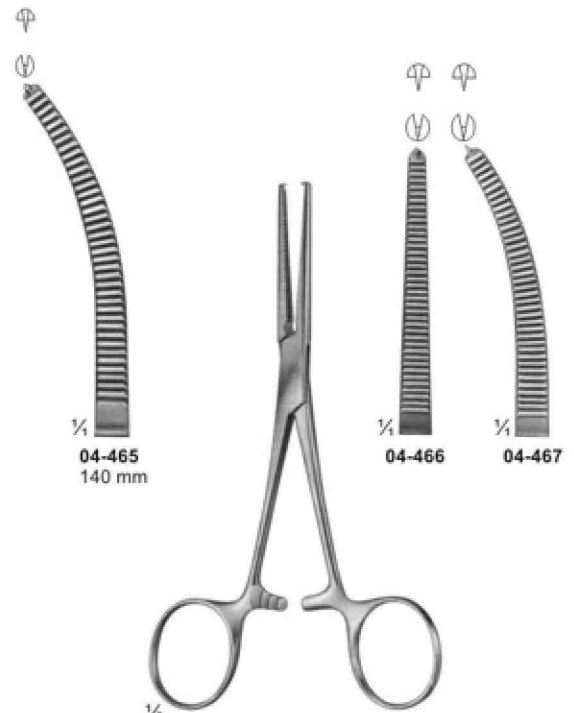

04-466 - 04-467
ROCHESTER-OGHSNER
140 mm

Haemostatic Forceps

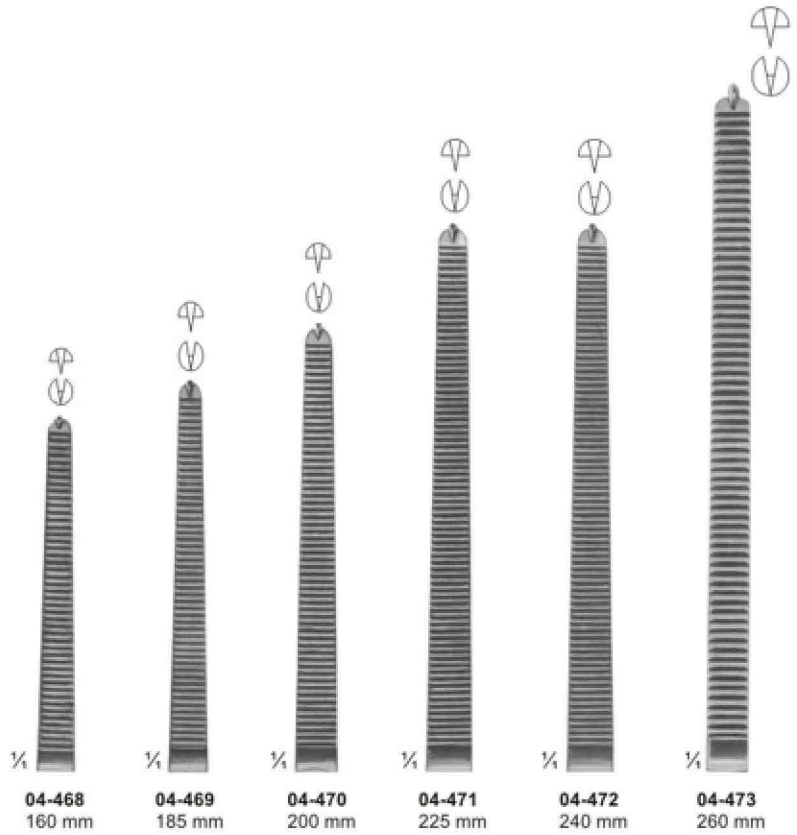

04-468 - 04-479
KOCHER-OCHSNER

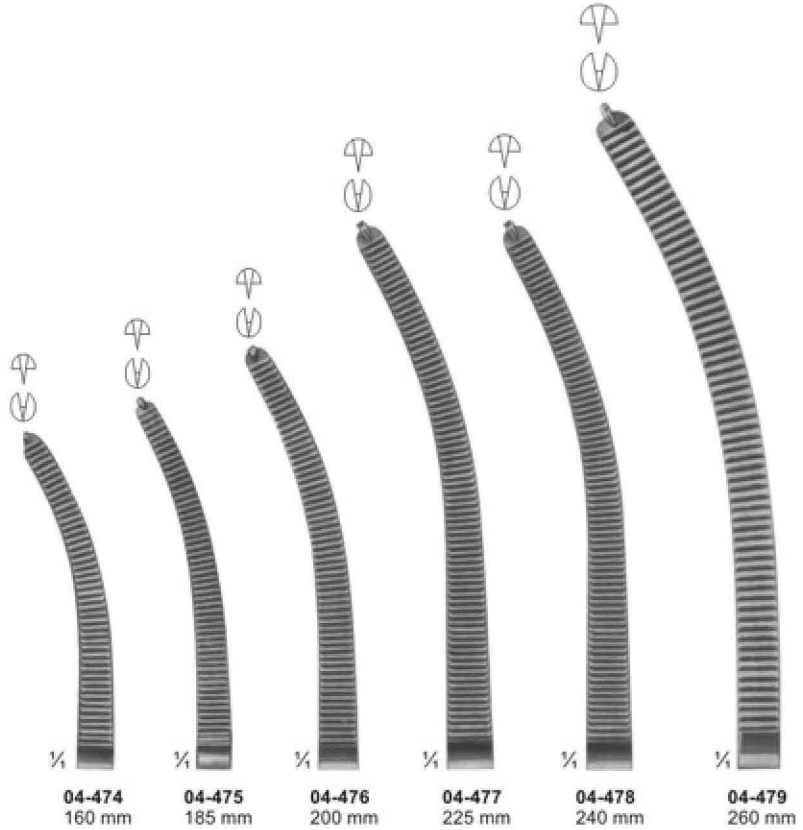

Haemostatic Forceps

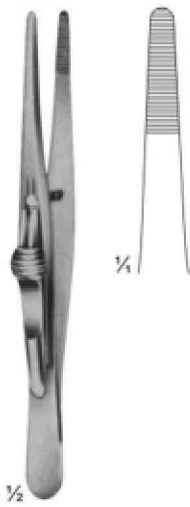

04-480
FRICKE
Artery forceps
130 mm

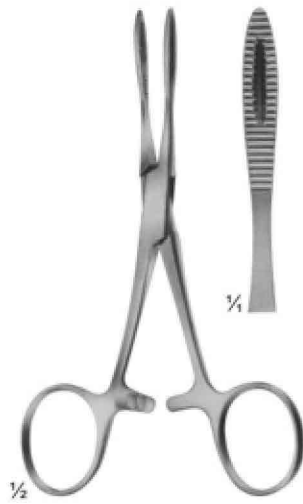

04-481
KRONLEIN
130 mm

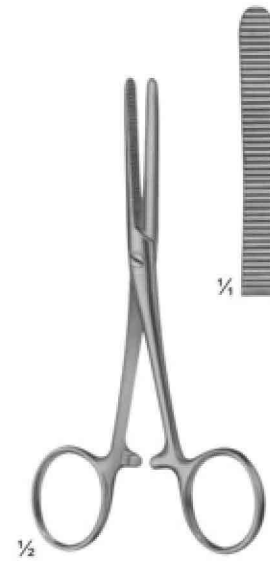

04-482
PEAN
125 mm



04-483
125 mm



04-484
140 mm

04-483 - 04-484
PEAN

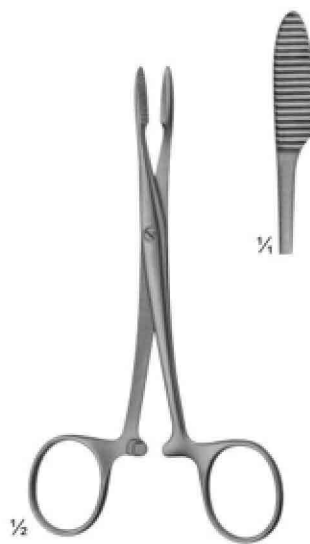

04-485
PEAN
125 mm

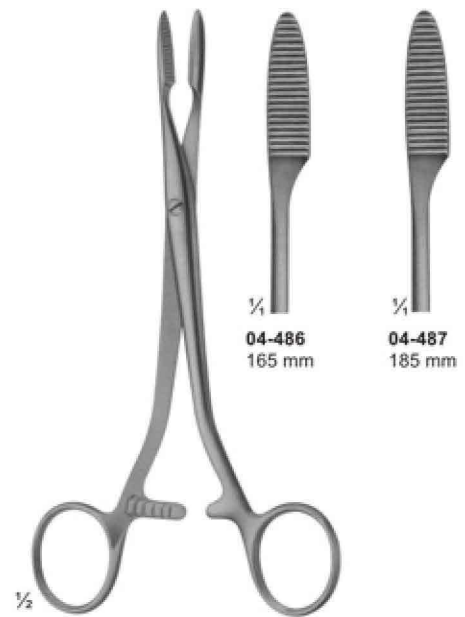

04-486
165 mm

04-487
185 mm

04-486 - 04-487
PEAN

Haemostatic Forceps, Special Pattern, Tonsil Forceps

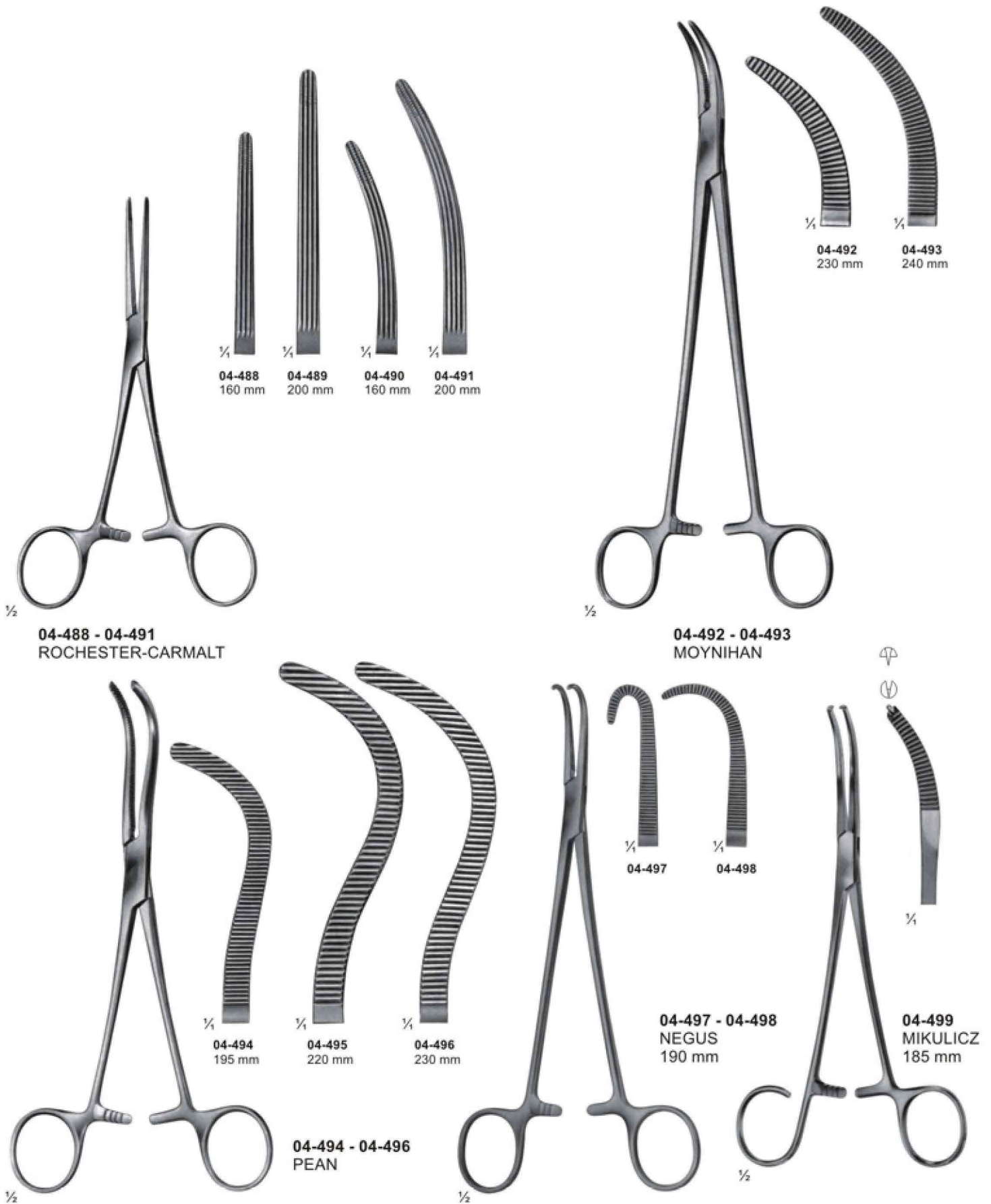

Dissecting- and Ligature Forceps



04-500
MIXTER-O'SHAUGHNESSY
190 mm

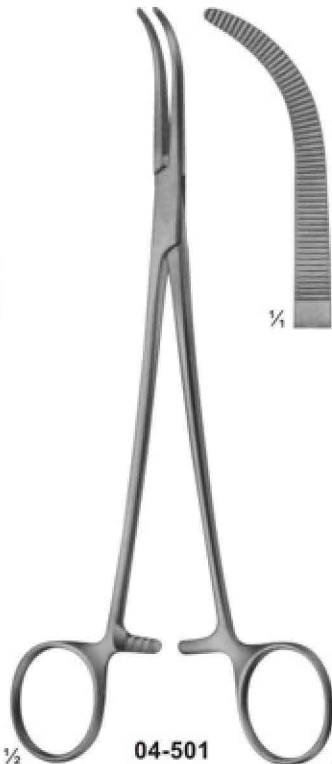

04-501
HEISS
195 mm

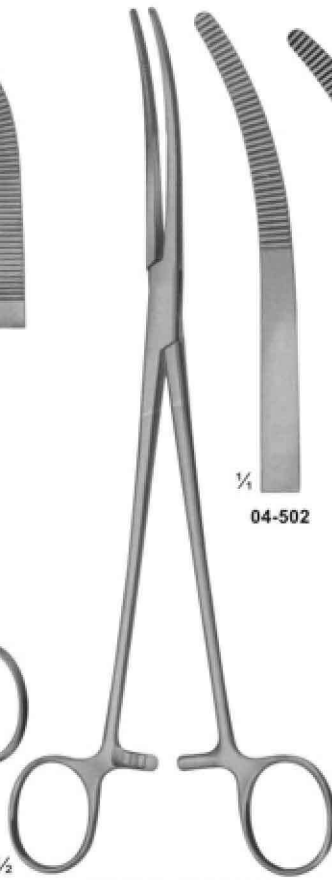

04-502 - 04-506
RUMEL
240 mm

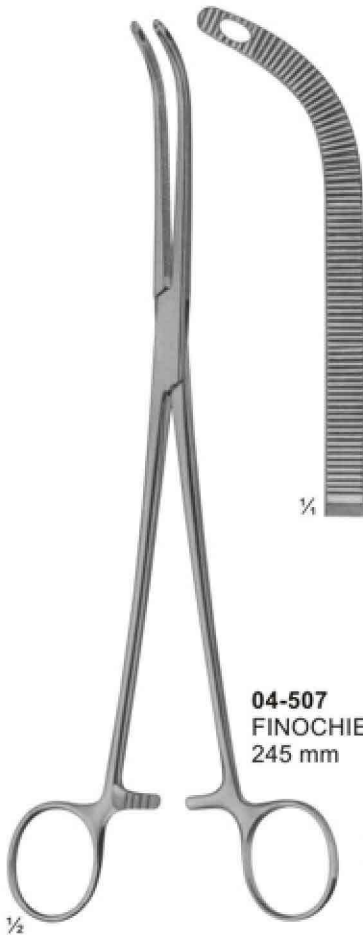
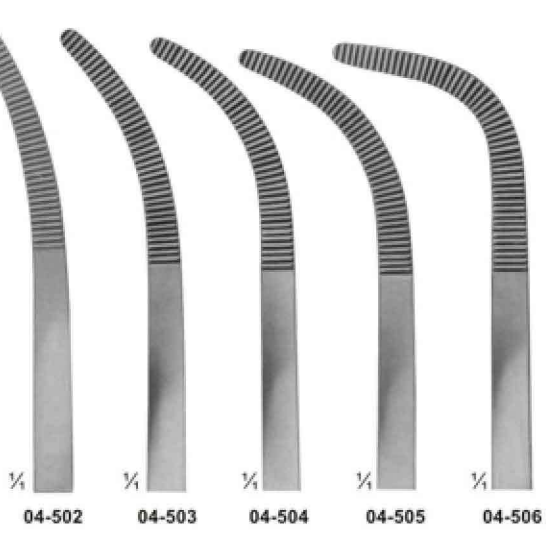

04-507
FINOCHIETTO
245 mm



04-508
MIXTER
230 mm



04-509
LAWRENCE
270 mm

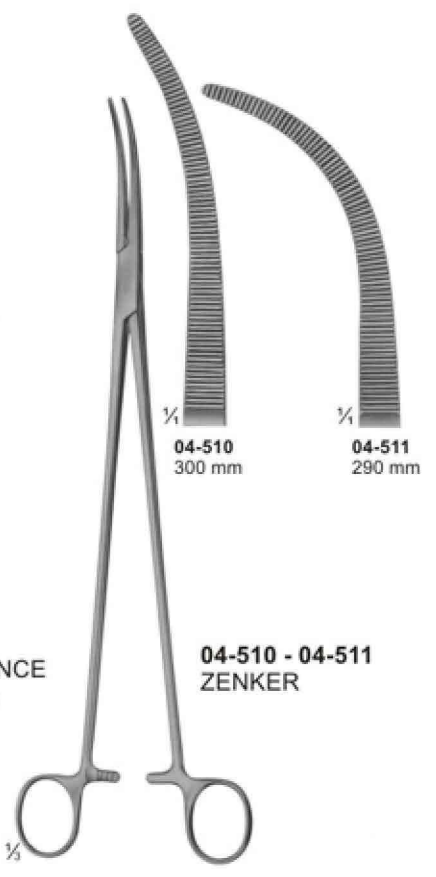

04-510 - 04-511
ZENKER

Hysterectomy Forceps, Vaginal Clamps and Compression Forceps



04-512
WERTHEIM
Hysterectomy forceps
255 mm

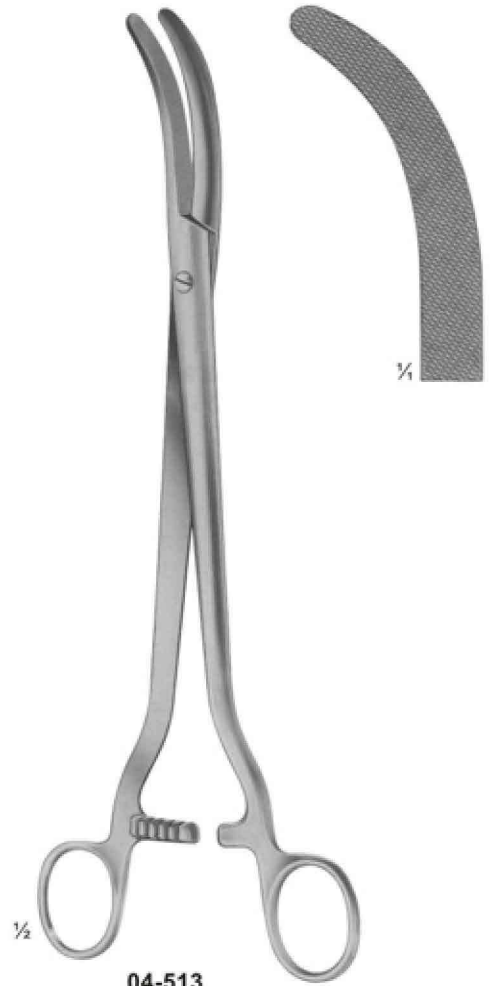

04-513
WERTHEIM
Parametrium clamp
260 mm



04-514 - 04-516
DICK



04-514 255 mm
04-515 265 mm
04-516 275 mm

Hysterectomy Forceps, Vaginal Clamps and Compression Forceps

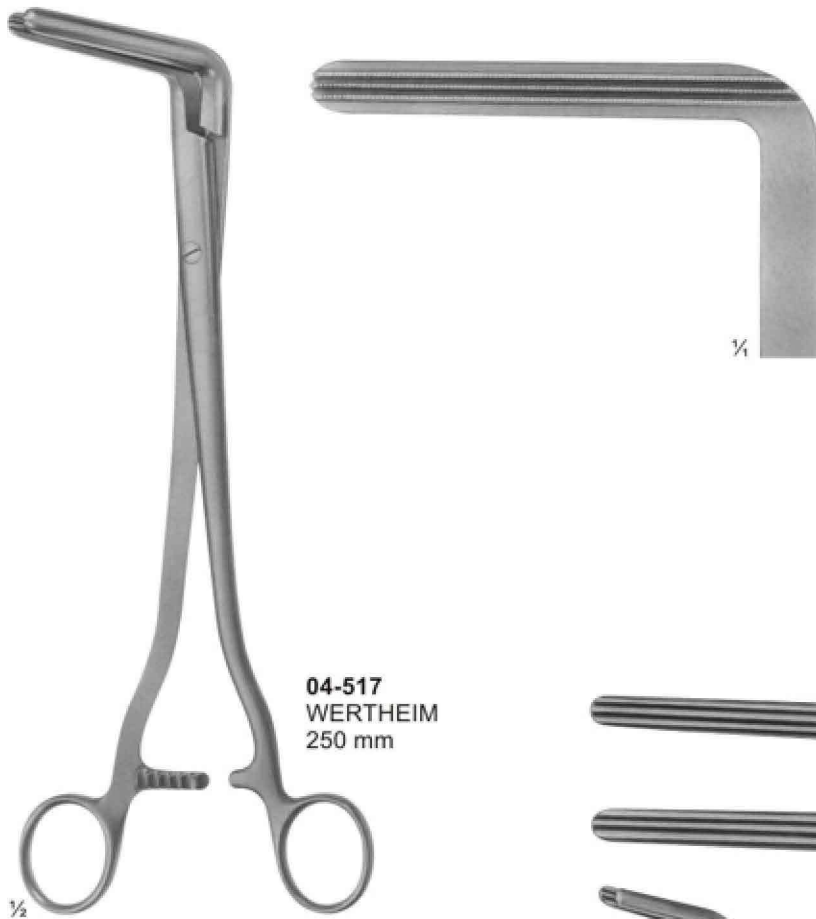

04-517
WERTHEIM
250 mm

1/2

1/4

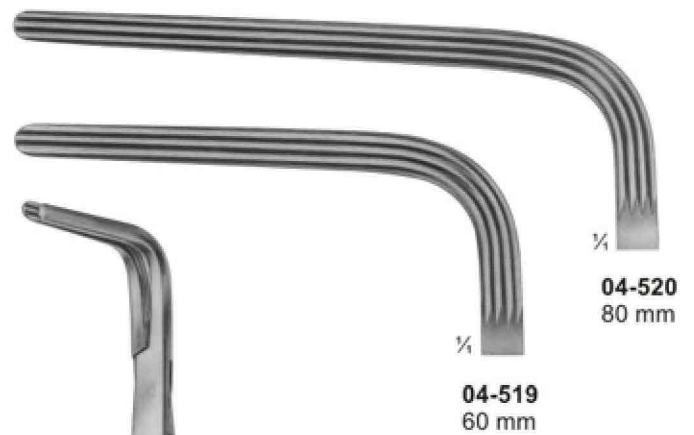

04-520
80 mm

04-519
60 mm

1/4

1/4



04-518
WERTHEIM-CULLEN
215 mm

1/4

1/2



04-519 - 04-520
230 mm

1/2

Needle Holders for micro surgery



05-101
ROHRSCHEIDER
with copper inserts
100 mm



05-102
KALT
with catch
135 mm



05-103
ARRUGA
with catch
135 mm



05-104 - 105
CASTROVIEJO
with catch
145 mm



05-106 - 107
without Catch
160 mm



05-108 - 109
without catch
185 mm

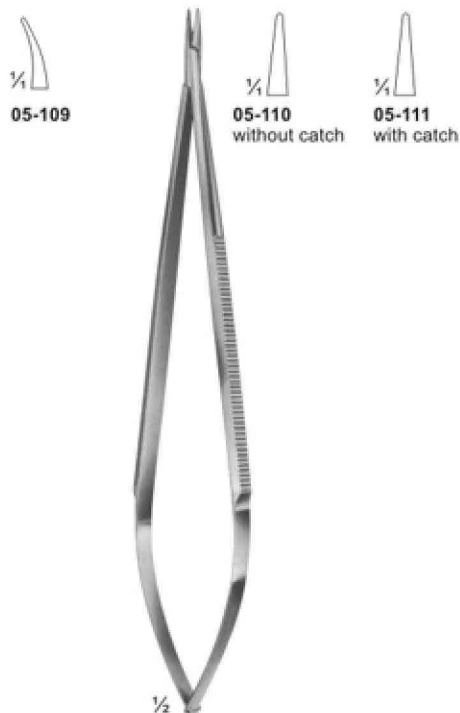

05-110 - 111
JACOBSON
185 mm



05-112
without catch
195 mm



05-113 - 114
YASARGIL
with catch
200 mm

Needle Holders

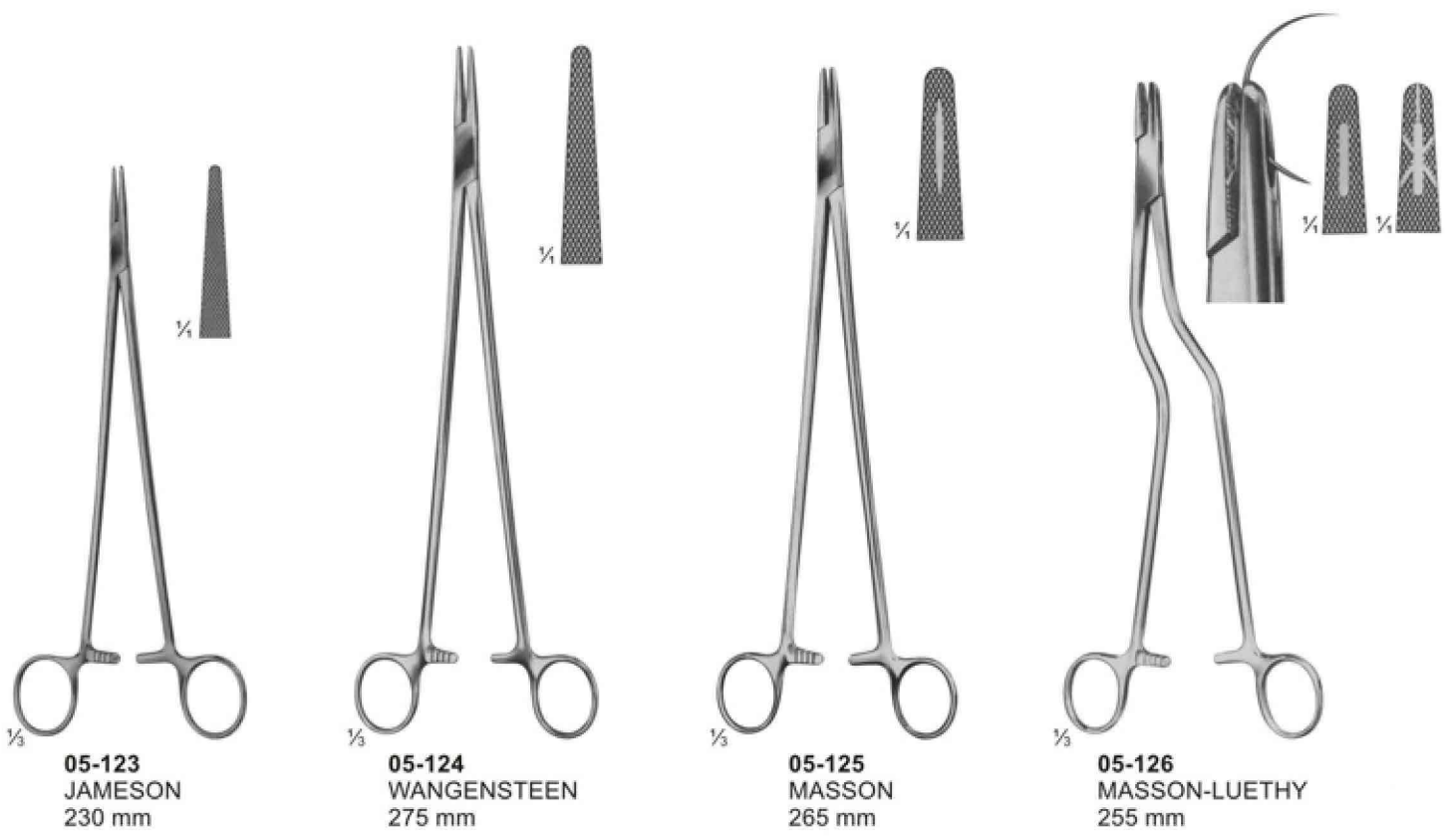
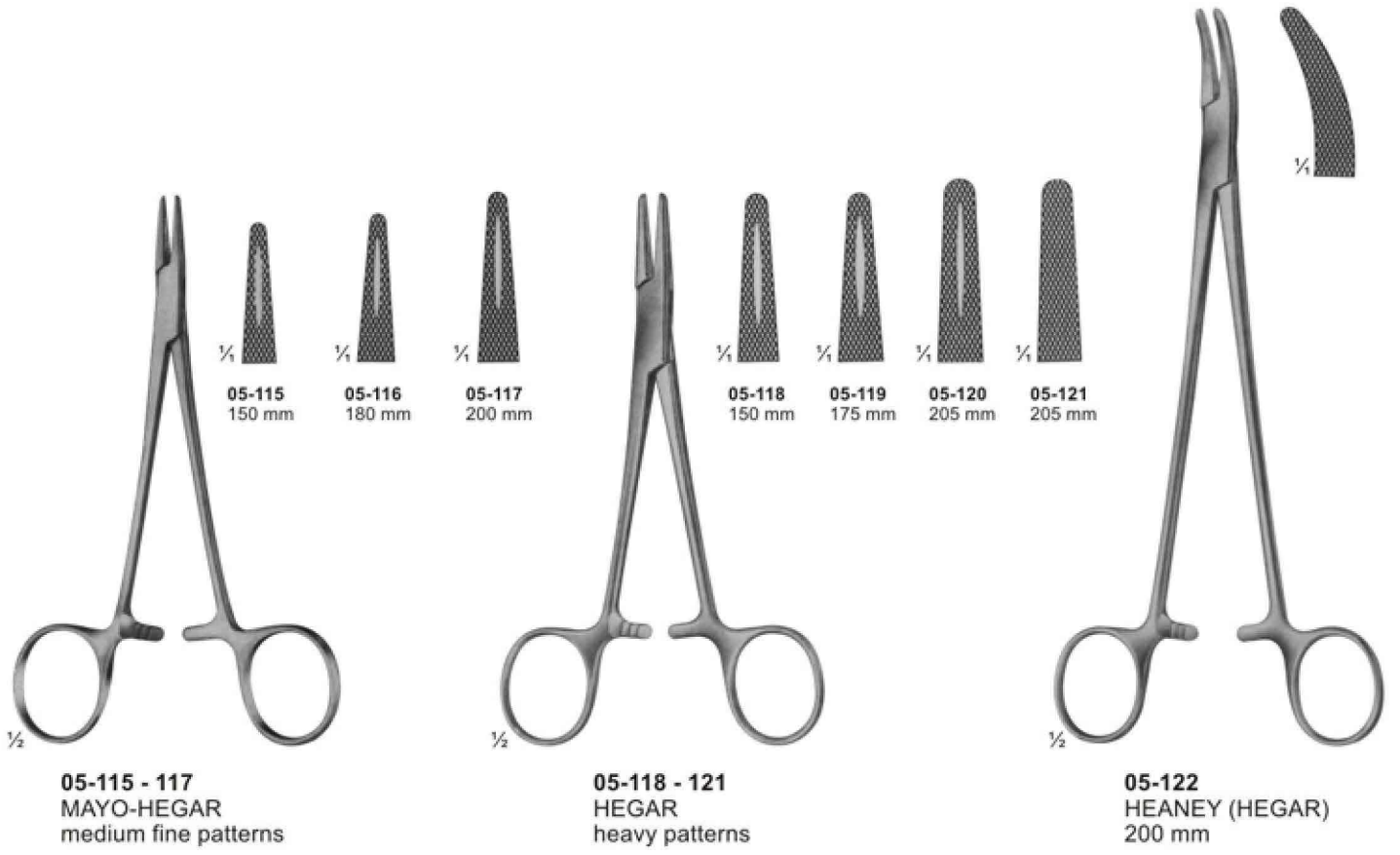

Needle Holders



05-127 - 128
HEGAR-OLSEN
255 mm

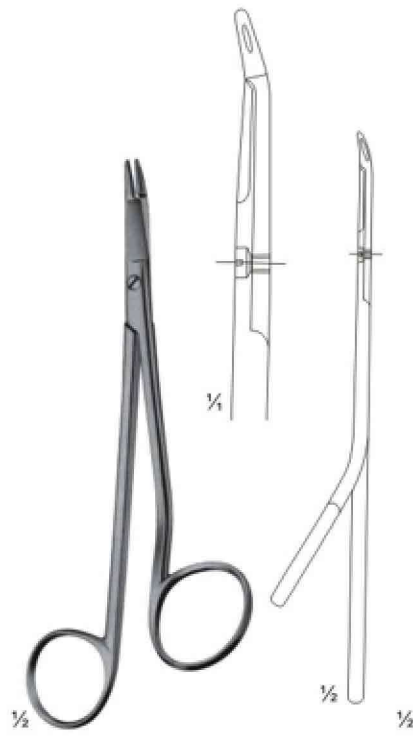

05-129
GILLIES
150 mm



05-130
GILLIES
160 mm

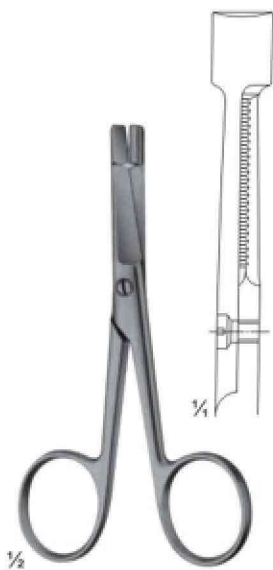

05-131
EISELSBERG
115 mm



05-132
SCHOEMAKER-LOTH
125 mm



05-133
CRILE
150 mm



05-134
TOENNIS
Elastic pattern for dura-or
intestinal suture. 180 mm

Needle Holders

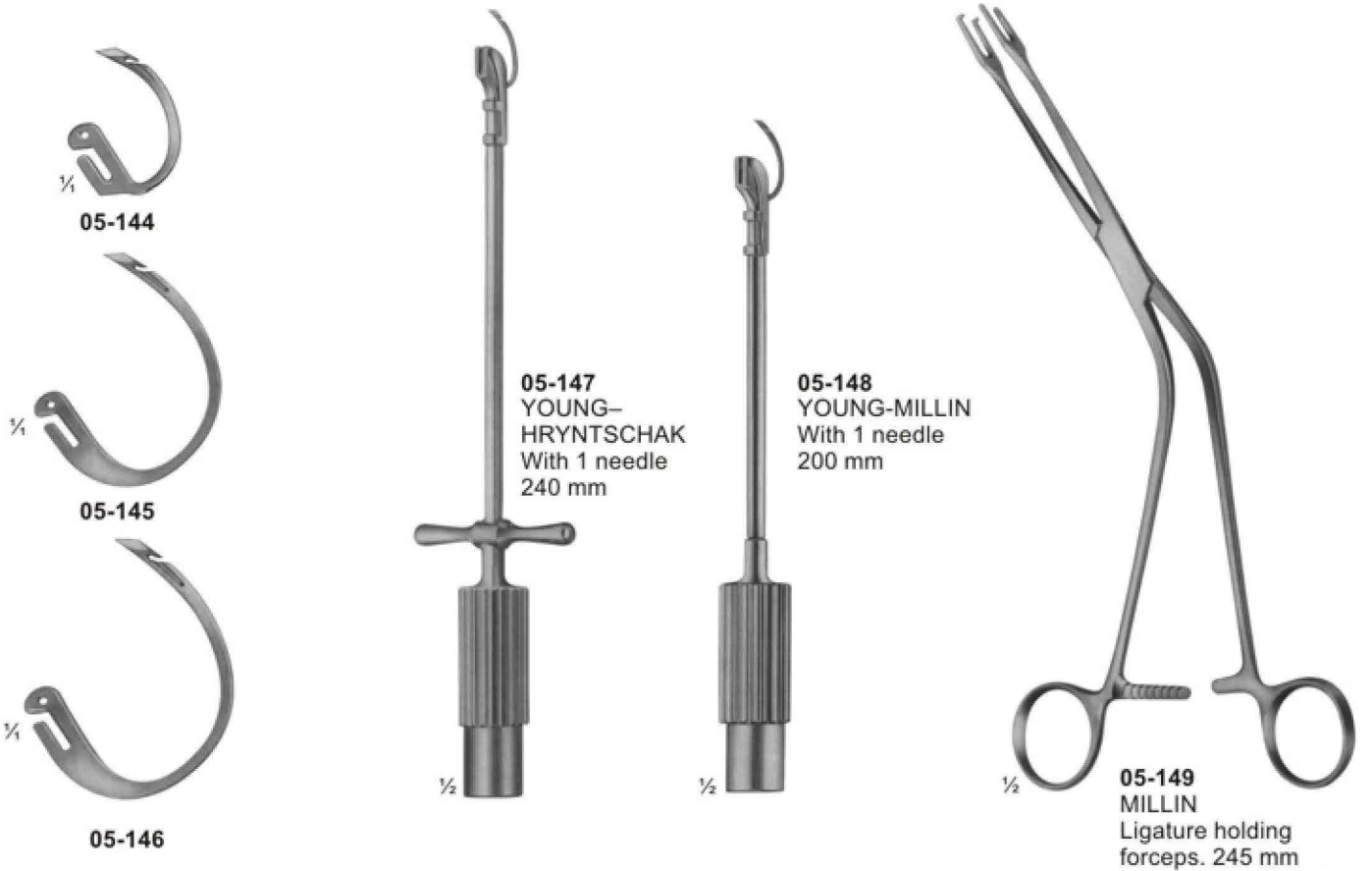
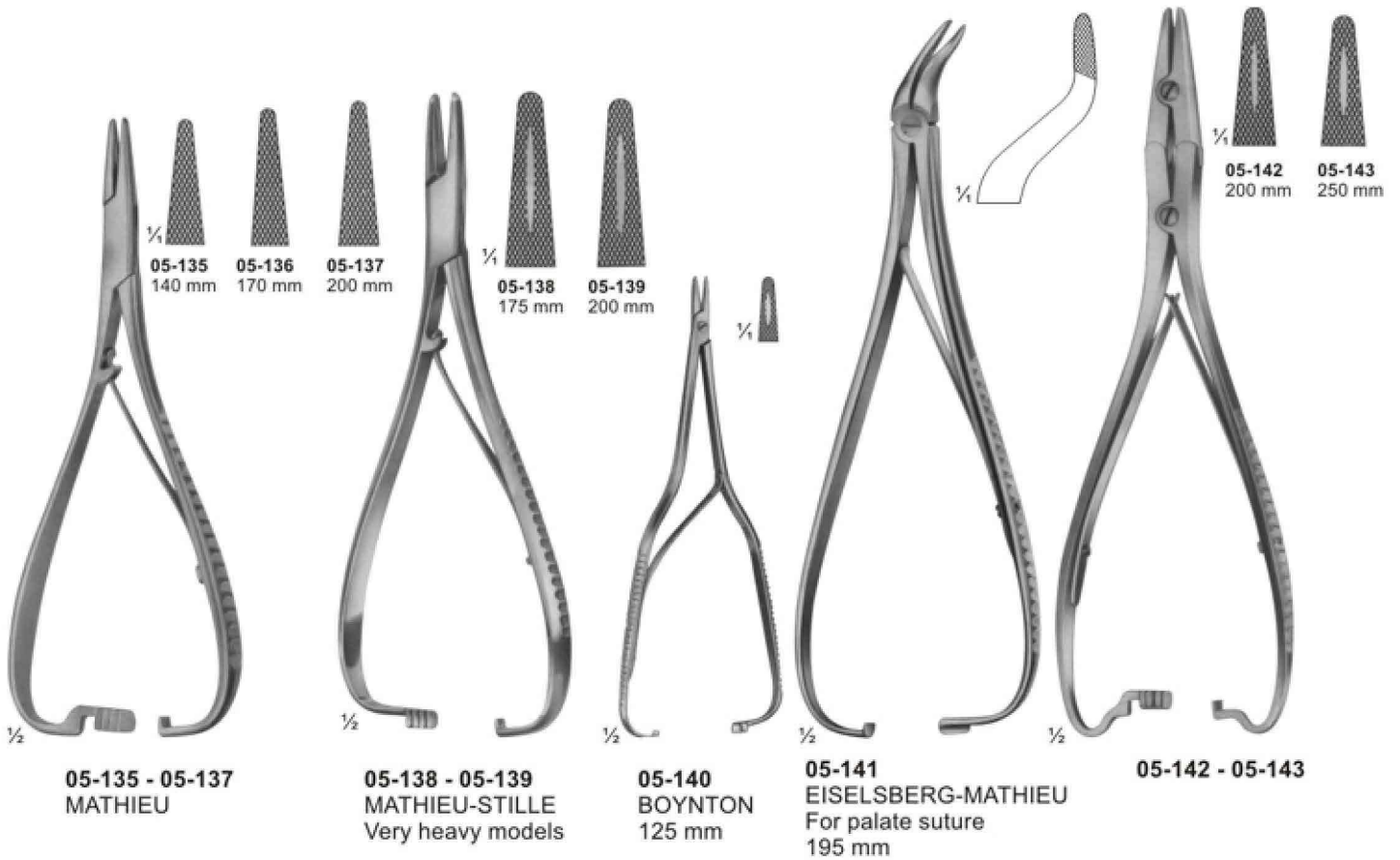

Suture Instruments - Reverdin Needles

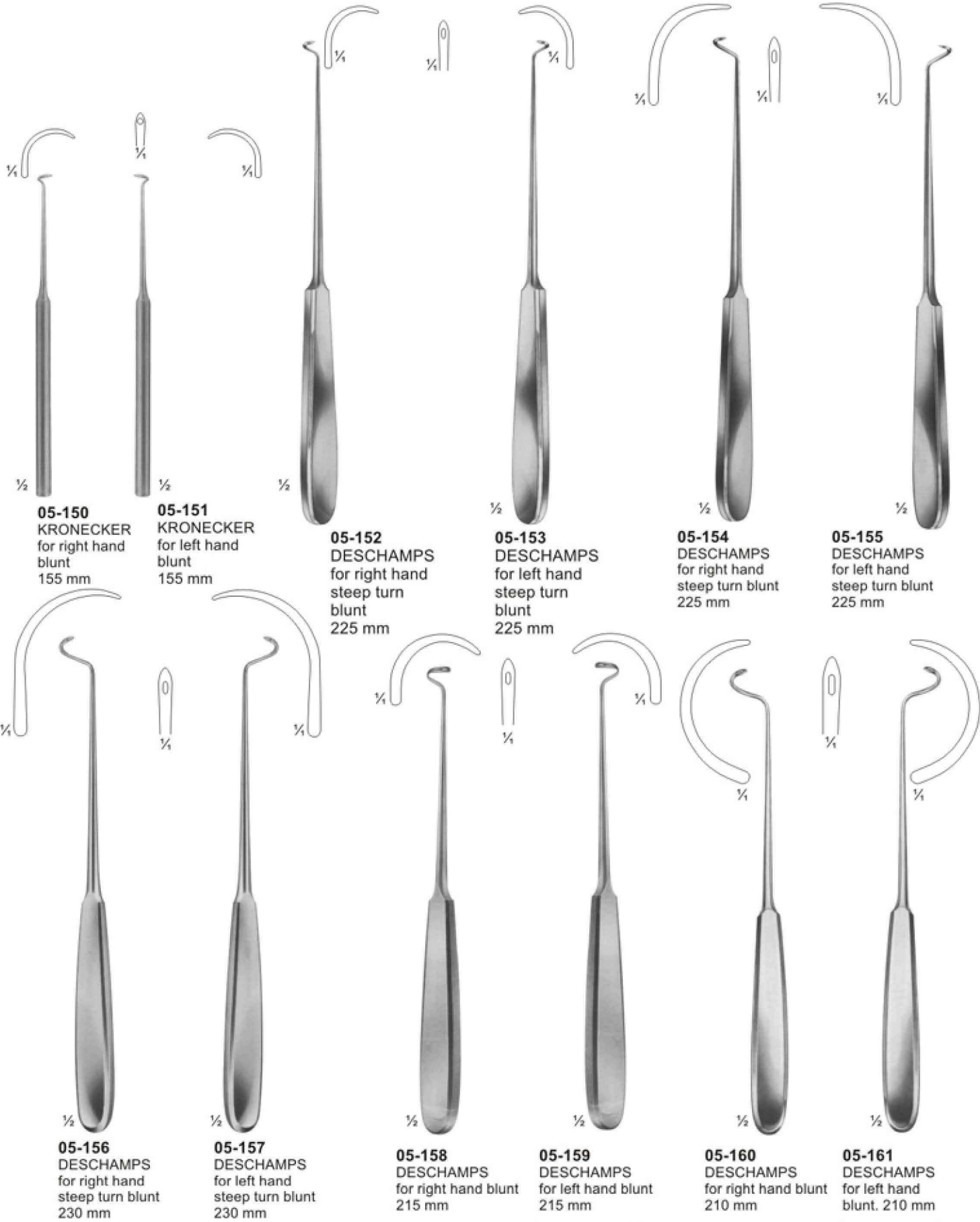

Probes

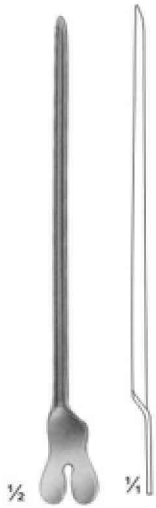

05-162 130 mm
05-163 145 mm
05-164 160 mm
 Directors



05-165
DOYEN
 145 mm
 Directors

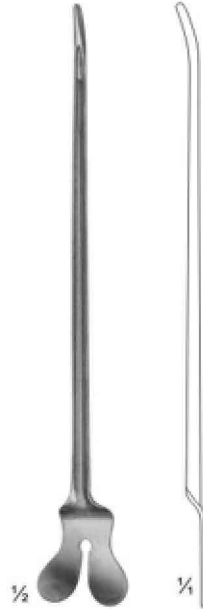

05-166
NELATON
 160 mm
 Directors



05-167
 Director with tip
 Diam. Of tip 3,3 mm
 140 mm

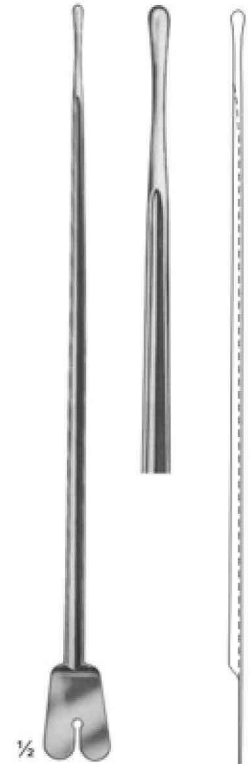

05-168
BRODIE
 Director with tip,
 Diam. Of tip 3,5 mm
 200 mm

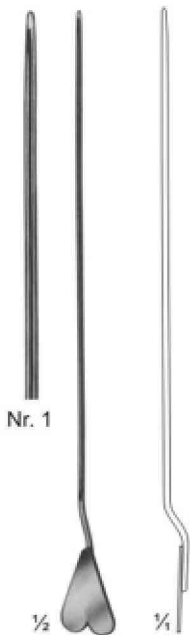

05-169
LOCKHART-MUMMERY
 165 mm



05-170
LOCKHART-MUMMERY
 165 mm

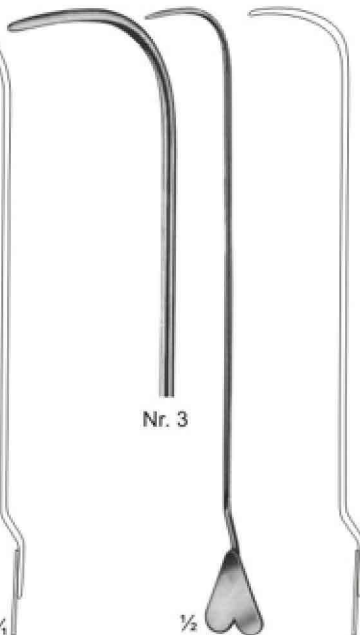

05-171
LOCKHART-MUMMERY
 165 mm

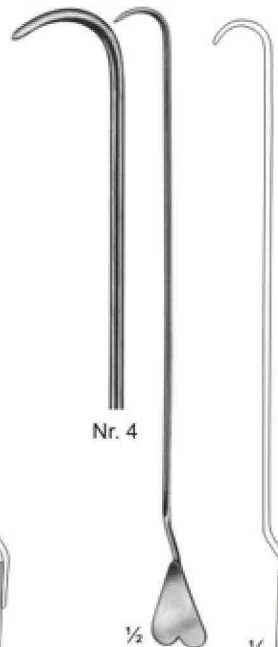

05-172
LOCKHART-MUMMERY
 165 mm



05-173
 Director with wire
 loop, malleable
 190 mm

Probes



05-174
2,5 mm
05-175
2,5 mm
05-176
3,0 mm

05-174 145 mm
05-175 160 mm
05-176 200 mm
Probes with eye



1,5 mm

05-177
Myrtle leaf probe
145 mm



2,0 mm

05-178 130 mm
05-179 145 mm
05-180 160 mm
05-181 180 mm
05-182 200 mm



05-183
Probes



05-184 1/2
Double ended probe,
malleable, diam. of tips
3 mm with hole
190 mm



05-185
Double ended probes,
tin, malleable,
diam. of tips
3,5 mm with hole
250 mm, 300 mm



05-186 1/4
Double ended probes,
tin, malleable,
diam. of tips 4 mm
400 mm



1/2 \varnothing tip
05-187 1,5 mm
05-188 2,0 mm
05-189 2,5 mm
300 mm

Suturing Instrument Set, Pocket Instrument Set



05-190

Suturing instruments set, in metal case consisting of: Scissors, curved, sharp/sharp, 115mm
25 MICHEL clip, 16 x 3mm
1 Delicate tissue forceps, 130mm
1 Scalpel, bellied
1 MATHIEU needle holder, 140mm
1 Perforated metal case, stainless containing:
1 Suture needle
1 item 1 item



05-191

Pocket instrument set, in metal case consisting of:

Bottom tray

1 MATHIEU needle holder, 140mm
1 MICHEL clip forceps, combined
1 Myrtle leaf probe, 130mm
1 Sharp double curette
1 Skin hook
1 Detachable scalpel handle, no.4
1 Perforated metal case, containing
6 Scalpel blades
1 Perforated metal case, stainless, containing
1 Suture needle
1 item
1 item

Top tray

1 Tissue forceps, 130mm
1 KOCHER haemostatic forceps, 130mm
1 Straight surgical scissors, 130mm
1 Dissecting forceps, 130mm
1 FEILCHENFELD splinter forceps, 115mm
25 MICHEL clip, 16 x 3mm
1 Flacon of suture skin, sterile in alcohol



05-192

Pocket instrument set, in metal case consisting of:

Bottom tray

1 MAYO-HEGER needle holder, 150mm
1 MICHEL clip forceps, combined
1 Myrtle leaf probe, 130mm
1 Sharp double curette
1 Skin hook
1 Detachable scalpel handle, no. 4
1 Perforated metal case, consisting
6 Scalpel blades
1 Perforated metal case, stainless, consisting:
1 Suture needle
1 item. & 1 item

Top tray

1 Tissue forceps, 130mm
1 CRILE haemostatic forceps, 140mm
1 Straight surgical scissors, 130mm
1 Dissecting forceps, 130mm
1 FEILCHENFELD splinter forceps, 115mm
25 MICHEL clip, 16 x 3mm
1 Flacon of suture silk, sterile in alcohol

Fine Wound Retractors (Dura- and Skin Retractors)

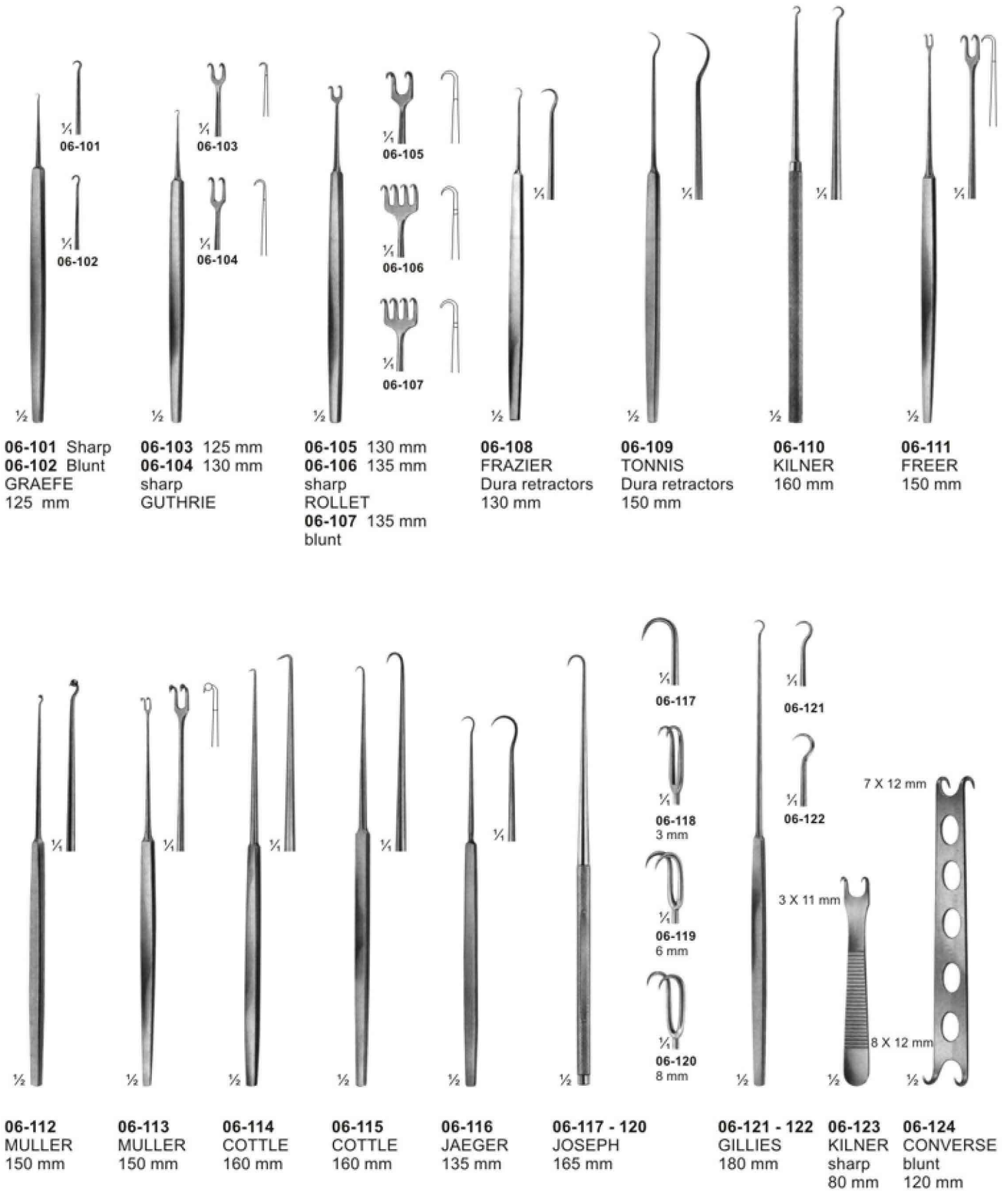

Retractors With treangle handle

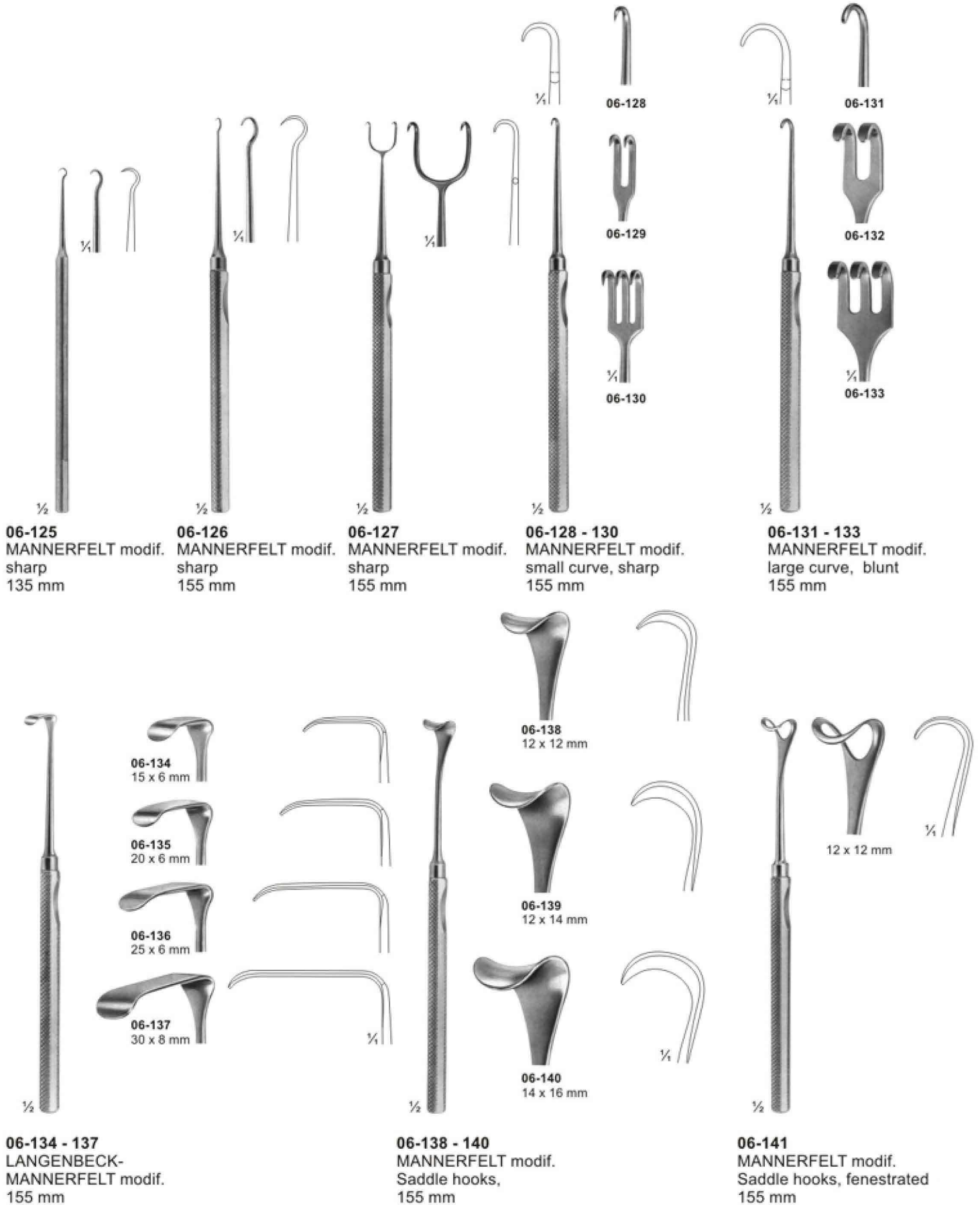

Retractors

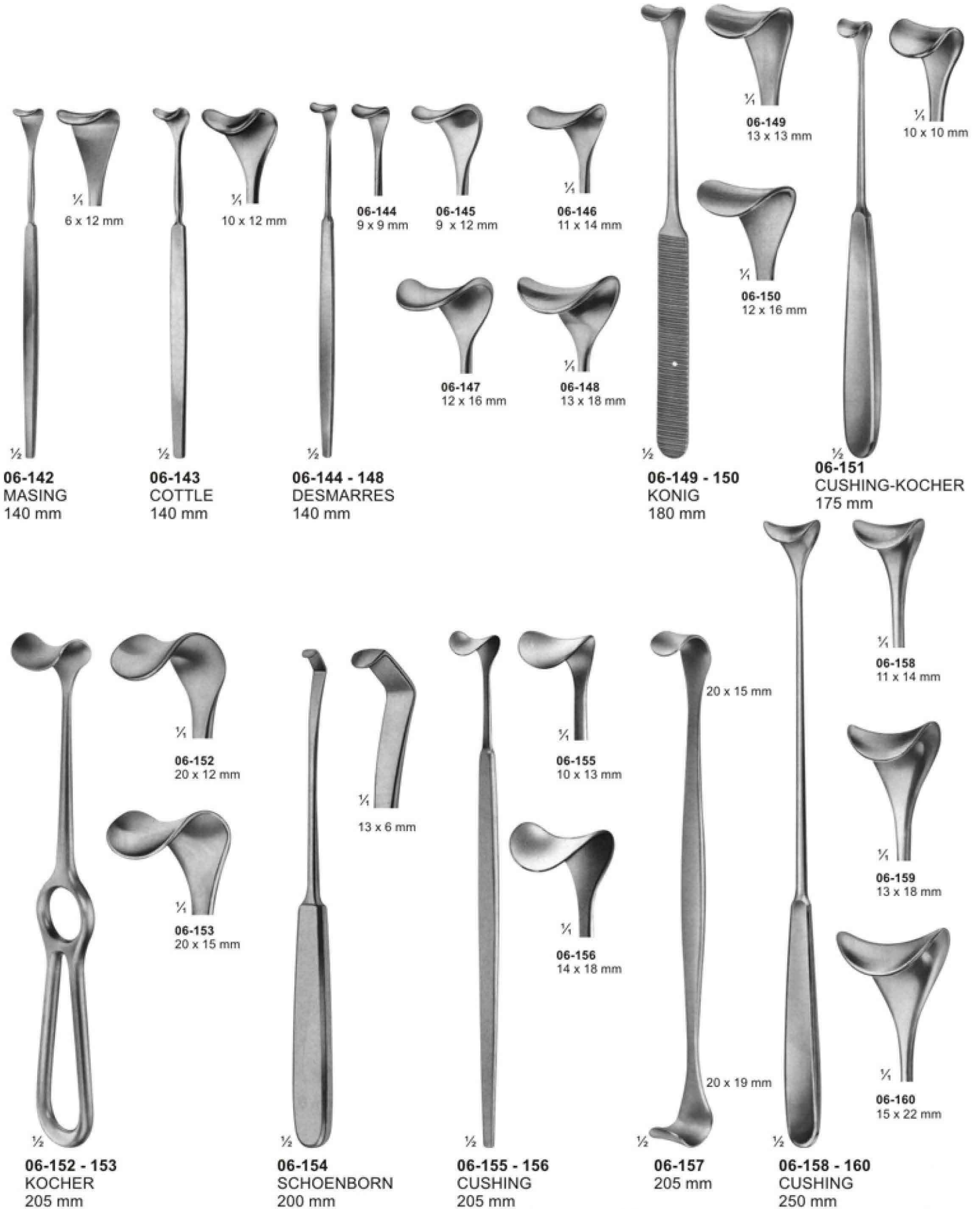

Retractors

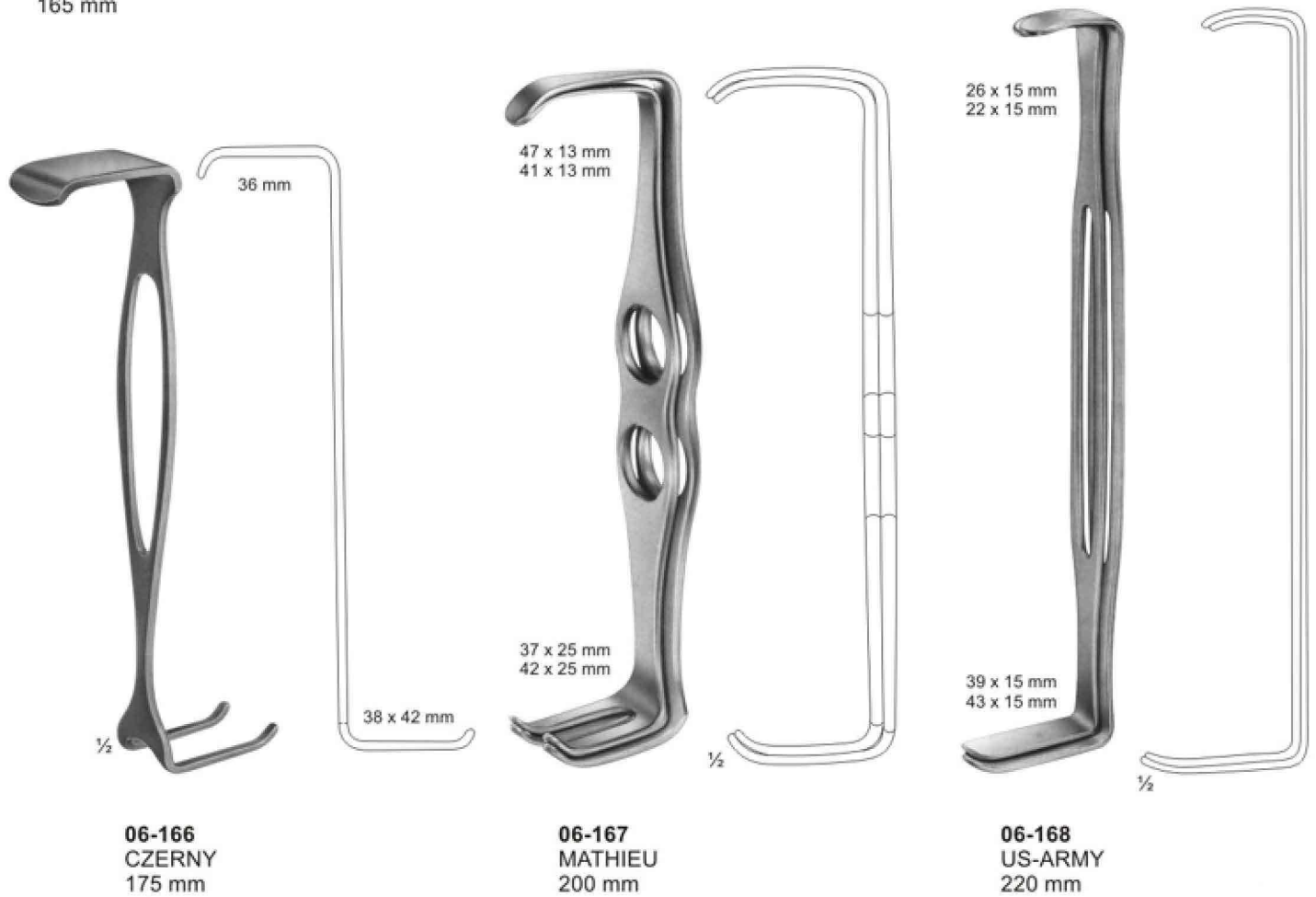
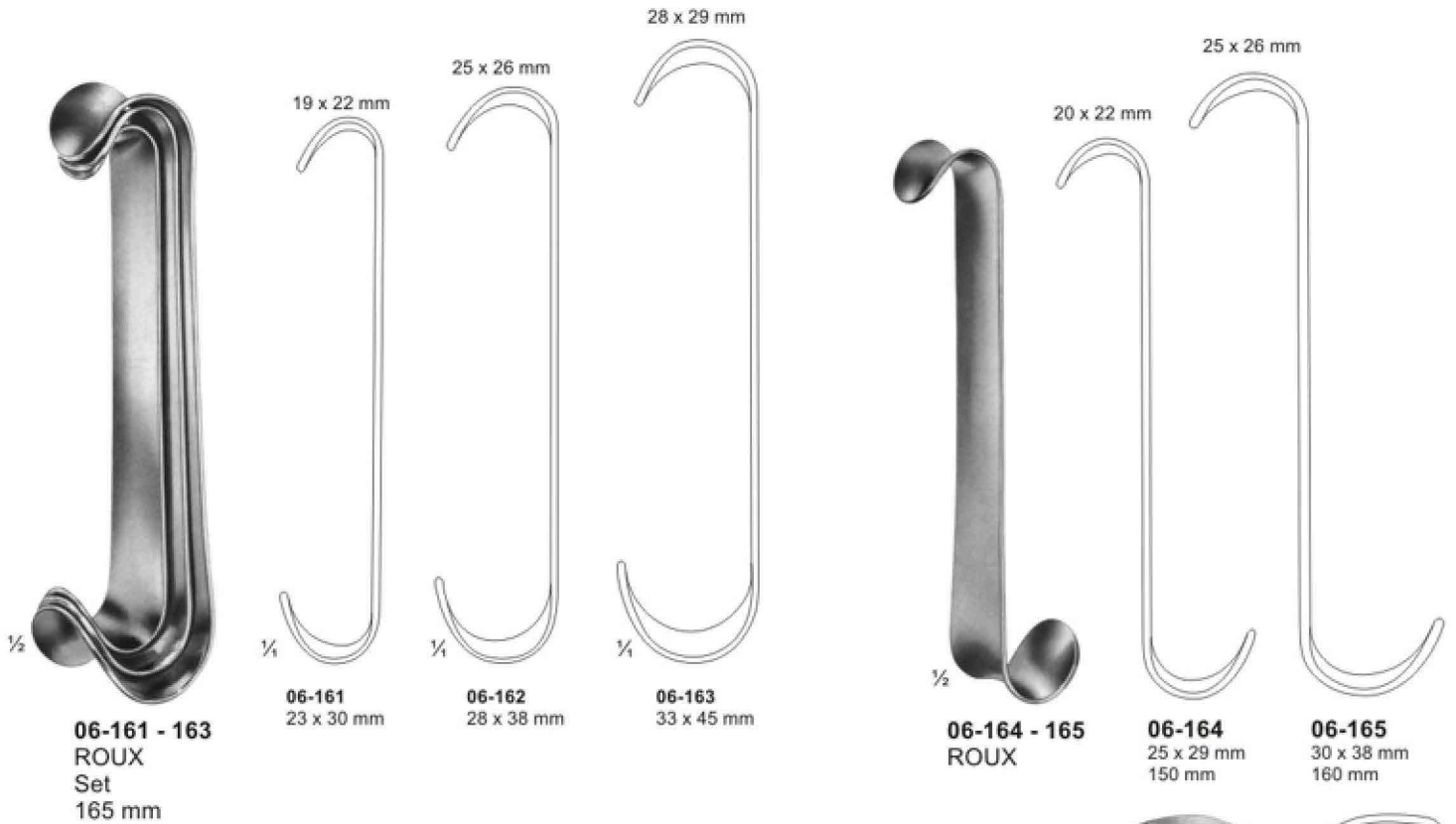

Retractors

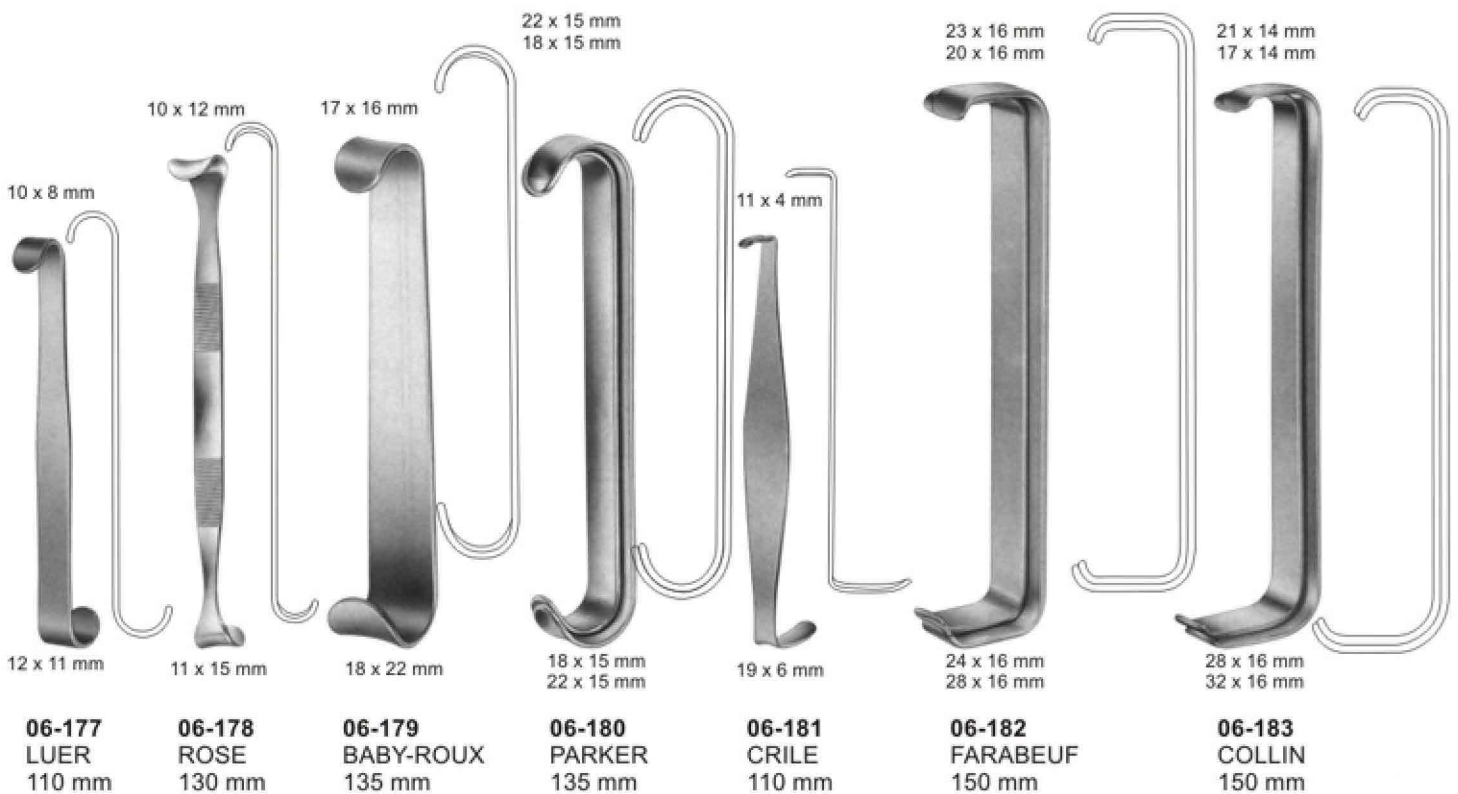

Bone Retractors and Retractors



06-184
KOCHER
sharp
205 mm



06-185
KOCHER
sharp
220 mm



06-186
KOCHER
sharp
220 mm



06-187
VOLKMANN
blunt
220 mm



06-188
VOLKMANN
sharp
220 mm



06-189 - 06-196
VOLKMANN
225 mm

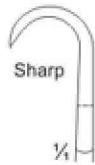

06-189
9 x 8 mm



06-190
9 x 13 mm



06-191
9 x 19 mm



06-192
9 x 29 mm



06-193
8,5 x 8 mm



06-194
8,5 x 13 mm



06-195
8,5 x 19 mm



06-196
8,5 x 29 mm

Retractors

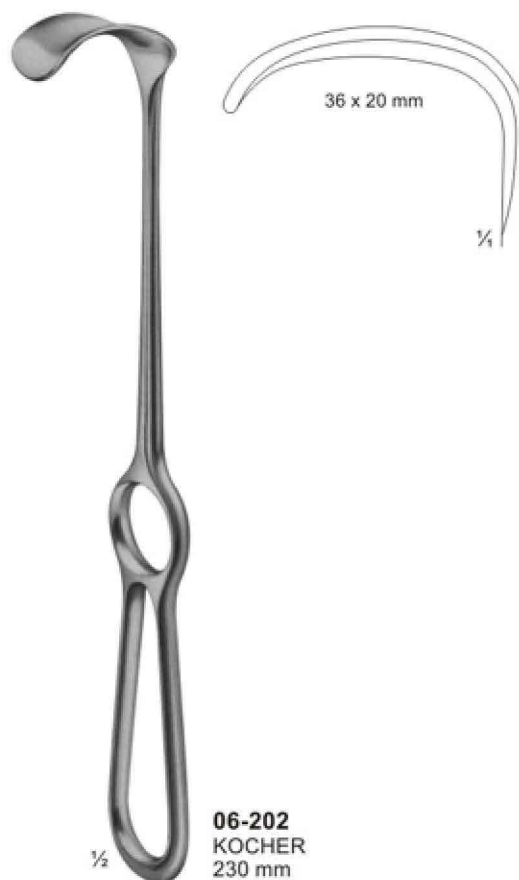
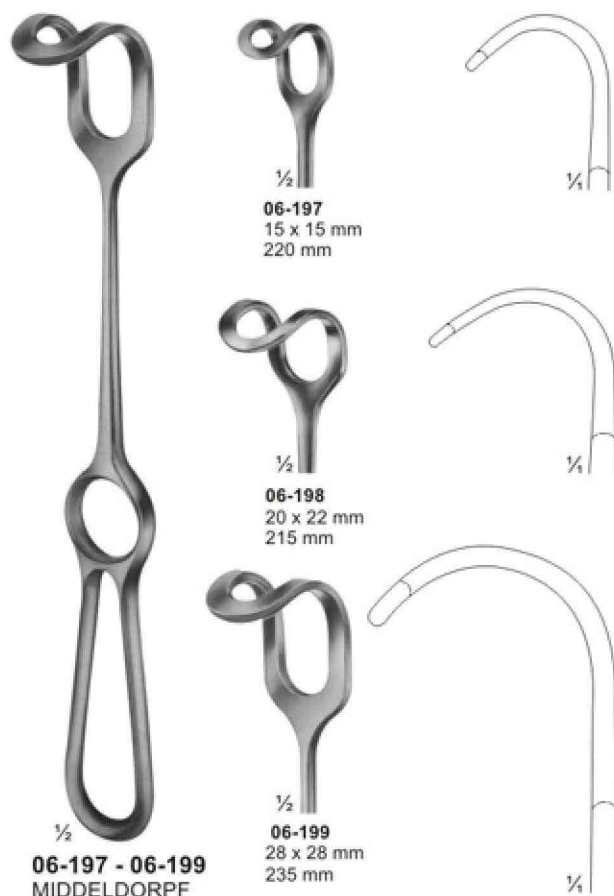

Retractors, Vario Retractor System



- 06-203- 06-209
BRUNNER**
275 mm
- 06-203** 80 x 20
 - 06-204** 100 x 25
 - 06-205** 120 x 25
 - 06-206** 130 x 30
 - 06-207** 140 x 30
 - 06-208** 160 x 30
 - 06-209** 180 x 30

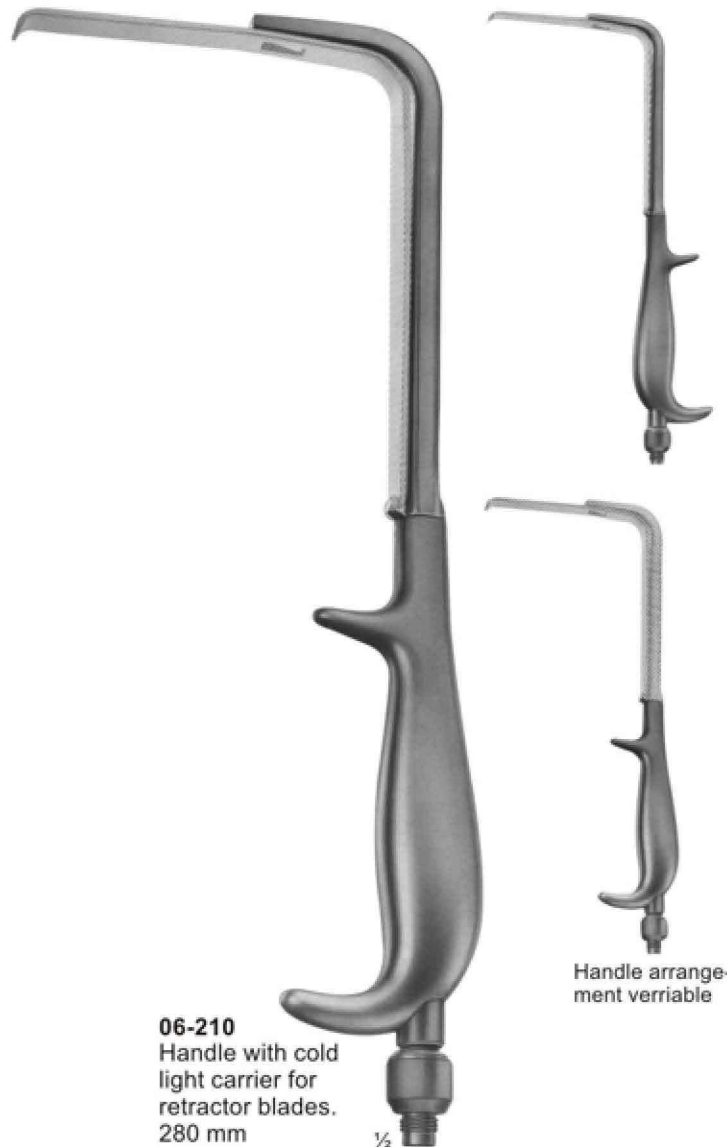

06-210
Handle with cold light carrier for retractor blades.
280 mm

Handle arrangement verriable

Retractors, Lung Spatulas



**Retractors for deep surgery
(Abdominal Retractors)**

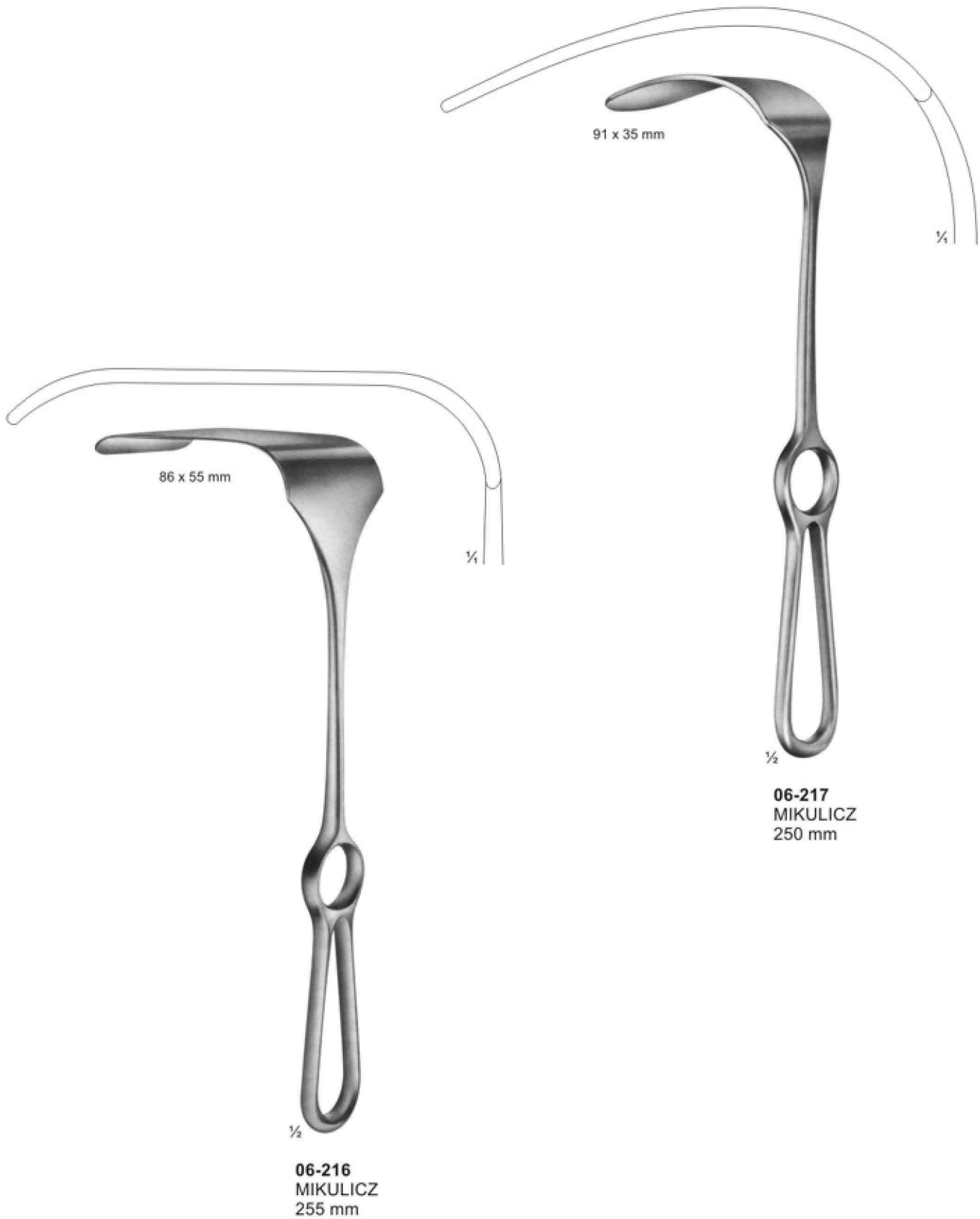

Retractors, Abdominal Retractors



- 06-229 Fig.1 32 x 40 mm
- 06-230 Fig.2 34 x 50 mm
- 06-231 Fig.3 41 x 60 mm
- 06-232 Fig.4 46 x 75 mm
- 06-233 Fig.5 64 x 85 mm

	width of blades	35 mm, 45 mm, 60 mm
length of blades	06-218, 06-222, 06-226	62 mm
	06-219, 06-223, 06-227	92 mm
	06-220, 06-224, 06-228	122 mm
	06-221, 06-225	160 mm

**Abdominal- and Intestinal Spatulas
Bauch- und Darmspatel**



06-235
LERICHE
255 mm

06-236
KUMMEL
Mealleable
285 mm

06-237
MIKULICZ
29 mm
250 mm

06-238 - 06-239
KADER
06-238 30 mm
06-239 40 mm
270 mm

Self-Retaining Retractors

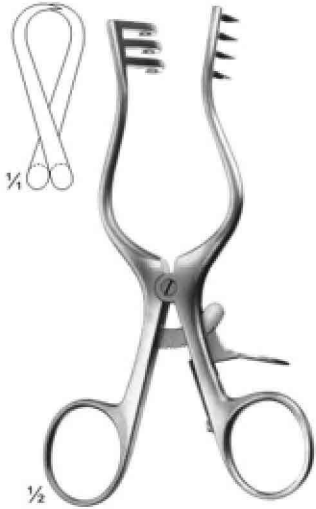

06-240
WEITLANER
sharp
130 mm

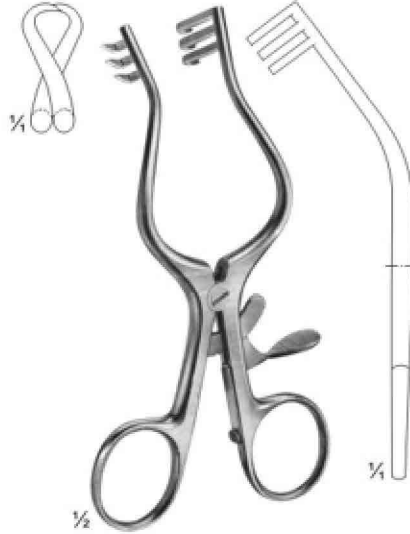

06-241
WULLSTEIN
sharp
130 mm

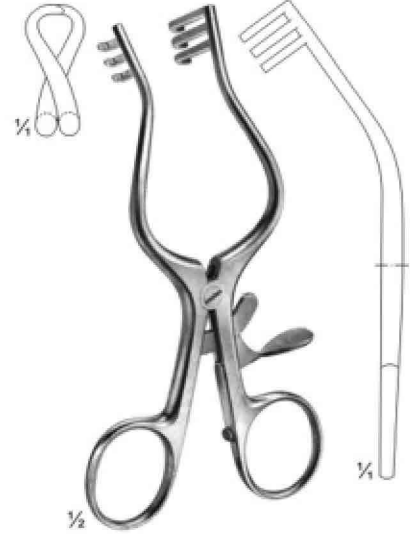

06-242
WULLSTEIN
blunt
130 mm



06-243
WEITLANER
sharp
165 mm



06-244
PLESTER
blunt
110 mm



06-245
PERKINS
130 mm

Special Retractors



06-246
JOLL (FRIEDMAN)
 Thyroid- and vaginal retractor
 155 mm

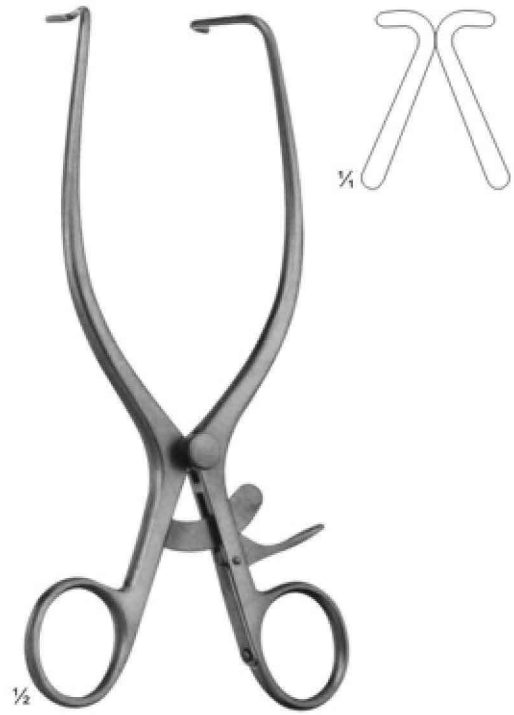

06-247
JACKSON BURROWS
 Retractor, blunt
 185 mm



06-248
GELPI
 Vaginal retractor
 135 mm



06-249
GELPI
 Skin- and vaginal retractor
 175 mm



06-250
DE BAKEY
 Femur retractor
 145 mm

Lamina Spreaders



06-251
CLOWARD
155 mm



06-252
CLOWARD
135 mm



06-253
INGE
170 mm

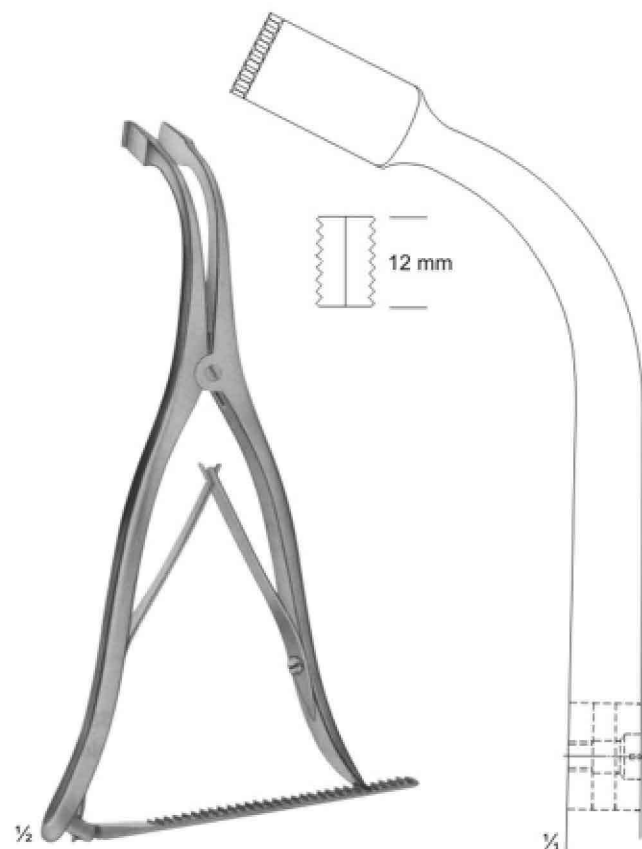

06-254
INGE
275 mm

Abdominal Retractors



06-255
GOSSET
 Blades:38 mm deep

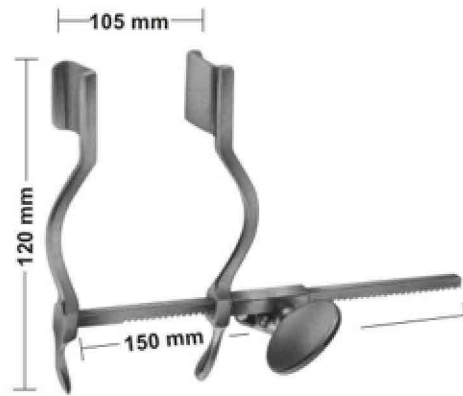

06-256
HERTZLER
 Blades 20 X 25 mm

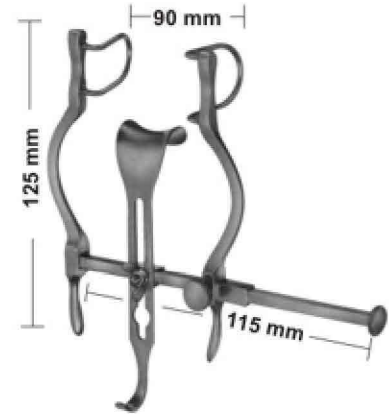

06-257
BALFOUR-BABY
 Lateral blades 27 mm deep
 Center blade 21x24 mm

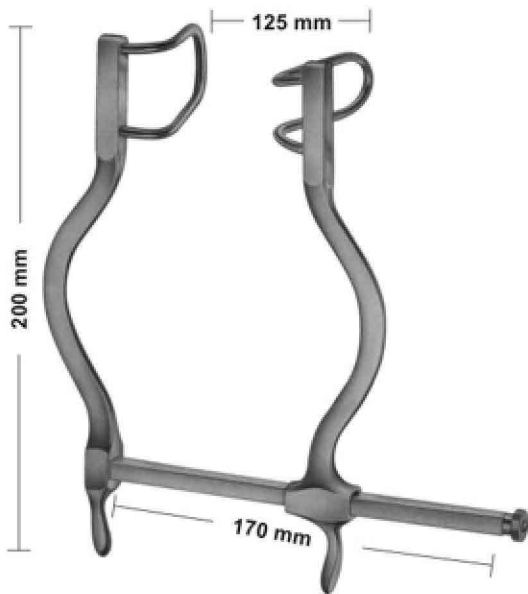

06-258
GOSSET
 Blades:55mm deep

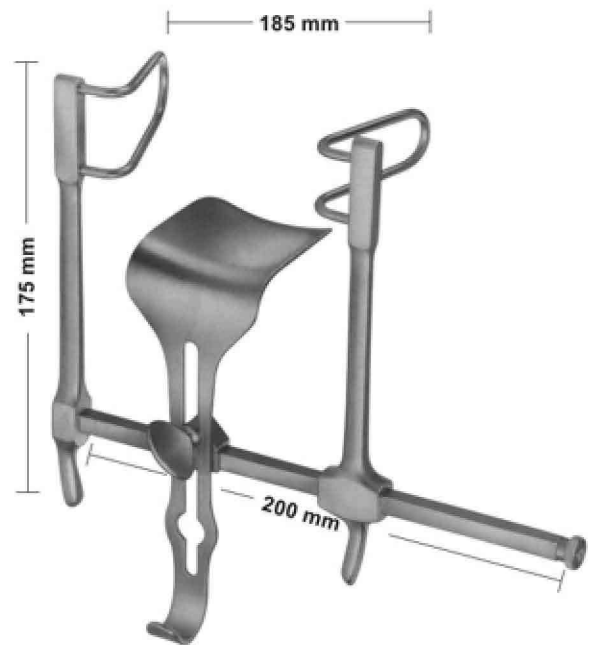

06-259
GOSSET
 Lateral blades 58 mm deep
 Center blade 59 x 57 mm

Abdominal Retractors

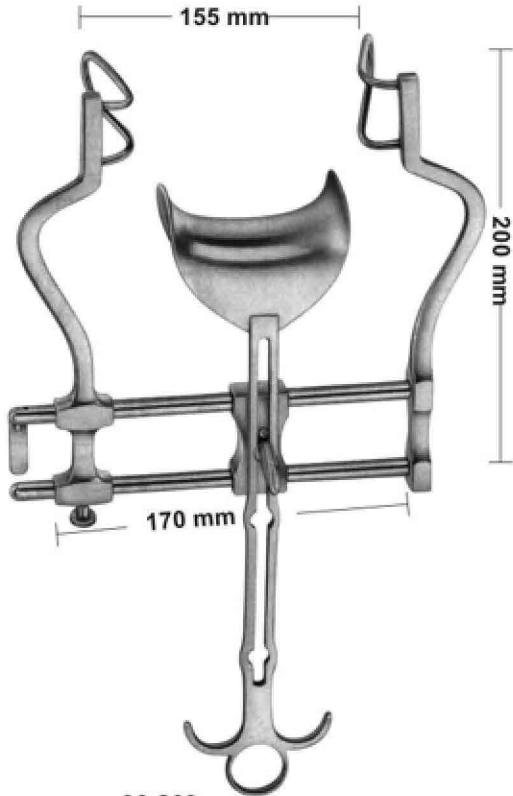

06-260
BALFOUR
Lateral blades 60 mm deep
Center blade 47 x 80 mm

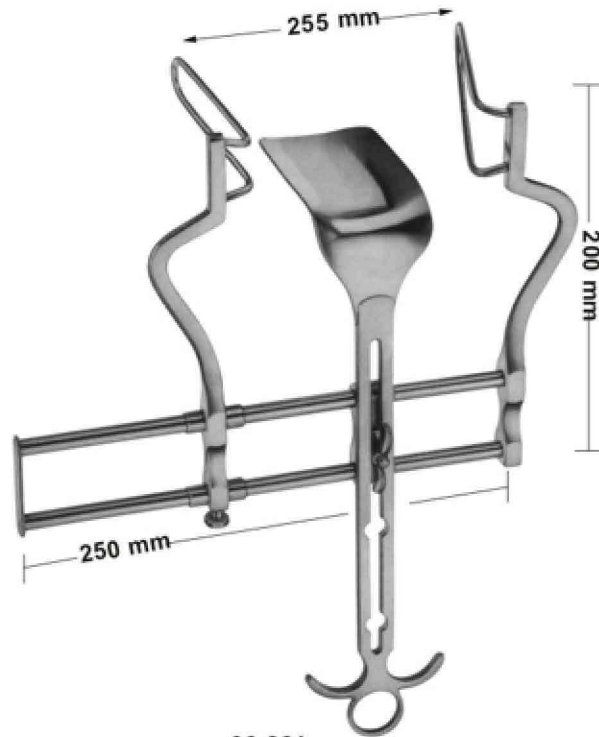

06-261
BALFOUR
Lateral blades 105 mm deep
Center blade 107x 59 mm

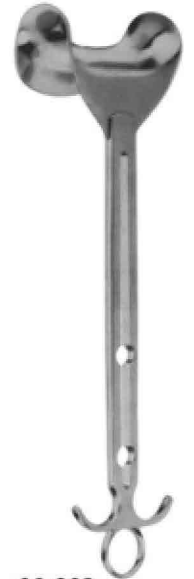

06-262
Center blade only
54x80 mm

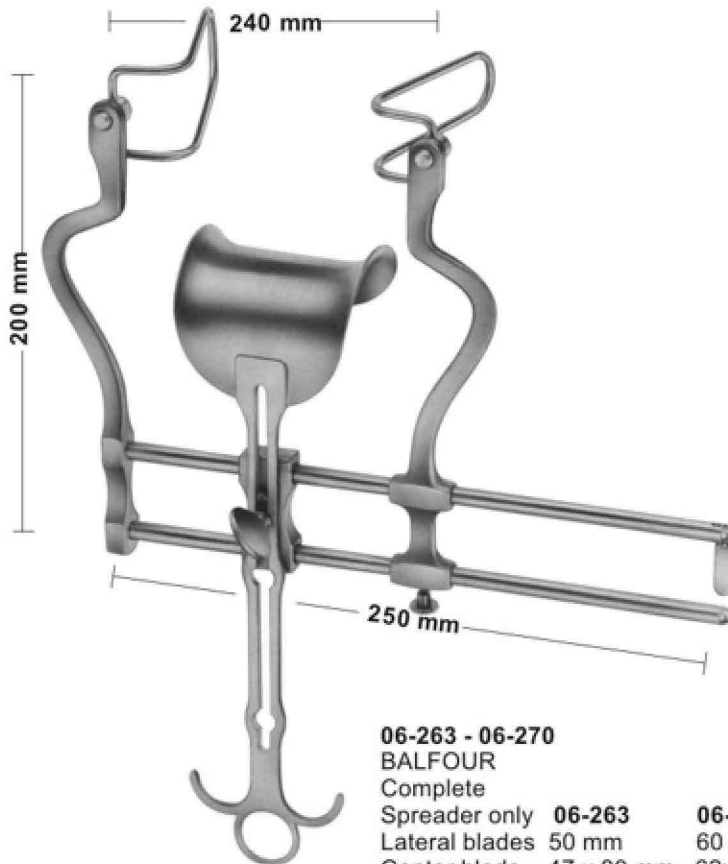

06-263 - 06-270
BALFOUR
Complete

Spreader only	06-263	06-264	06-265	06-266
Lateral blades	50 mm	60 mm	75 mm	90 mm
Center blade	47 x 80 mm	62x76 mm	80x80 mm	80x80 mm



Lateral blades
06-267 50 mm deep
06-268 60 mm deep
06-269 75 mm deep
06-270 90 mm deep
 Sales Unit of blades: PR = pair

Organ-, Tissue and Intestinal Grasping Forceps

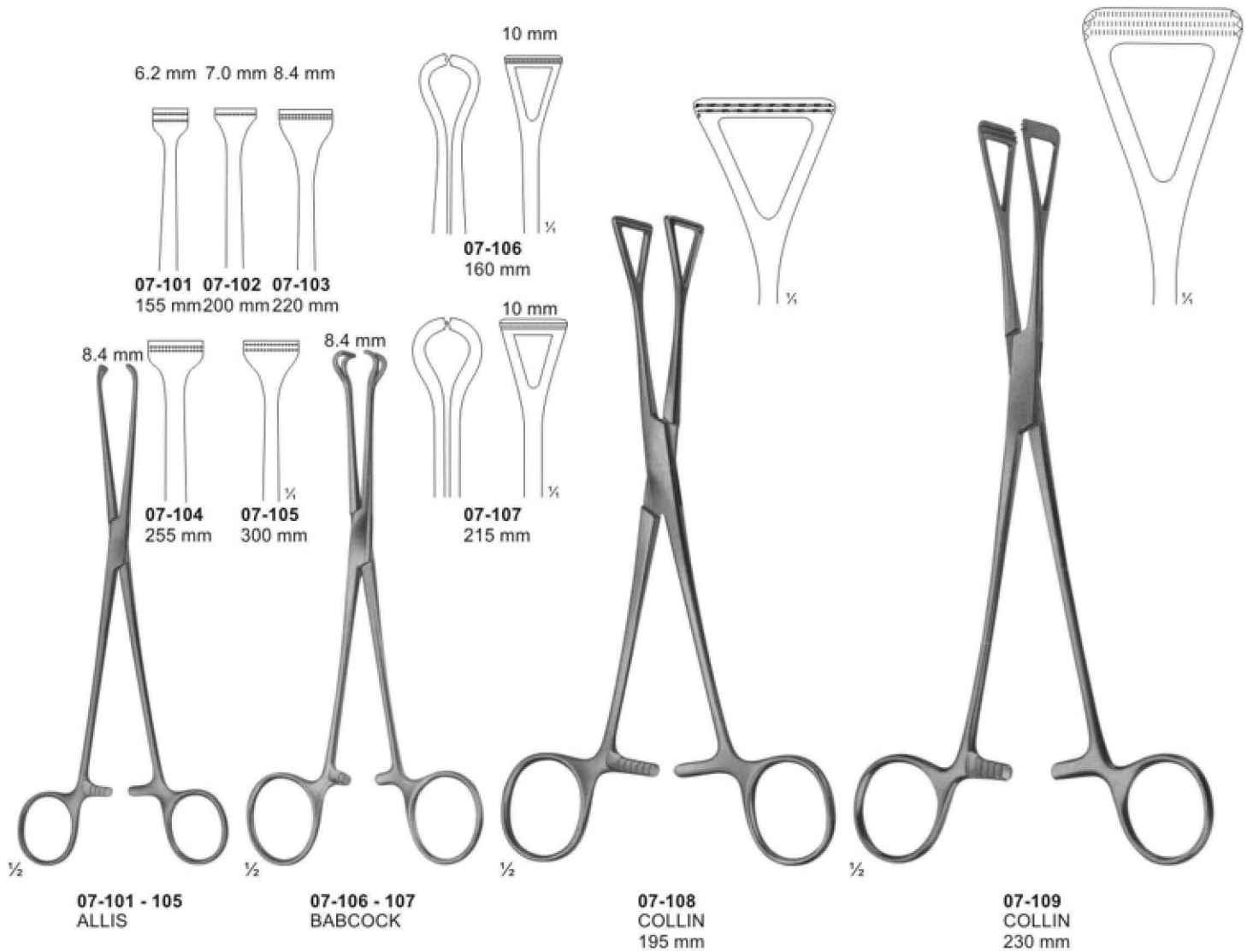

Intestinal Clamps, soft elastic

ATRAUMATA

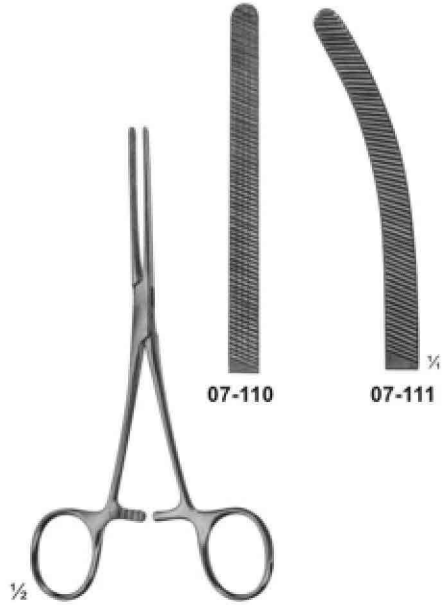

07-110 - 111
DOYEN
elastic
165 mm

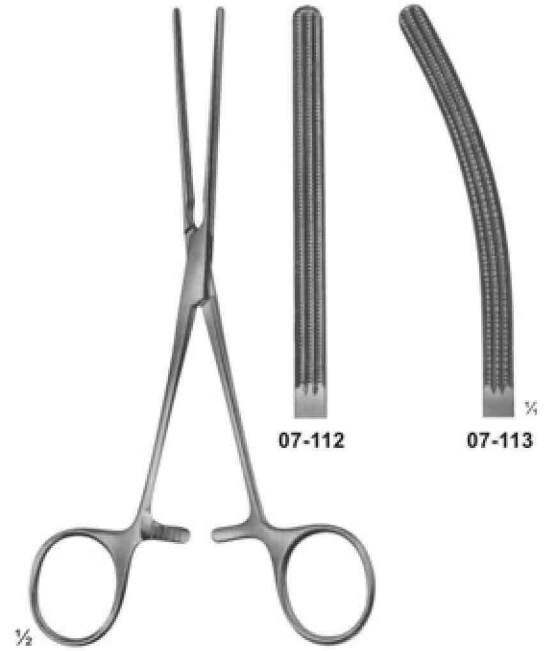

07-112 - 113
DOYEN
with elastic blades
170 mm

ATRAUMATA

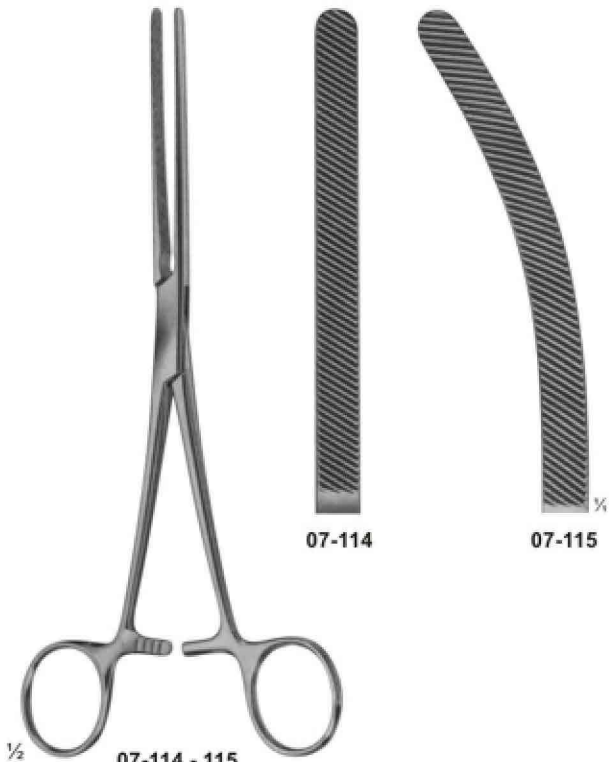

07-114 - 115
HARTMANN
with elastic blades
200 mm

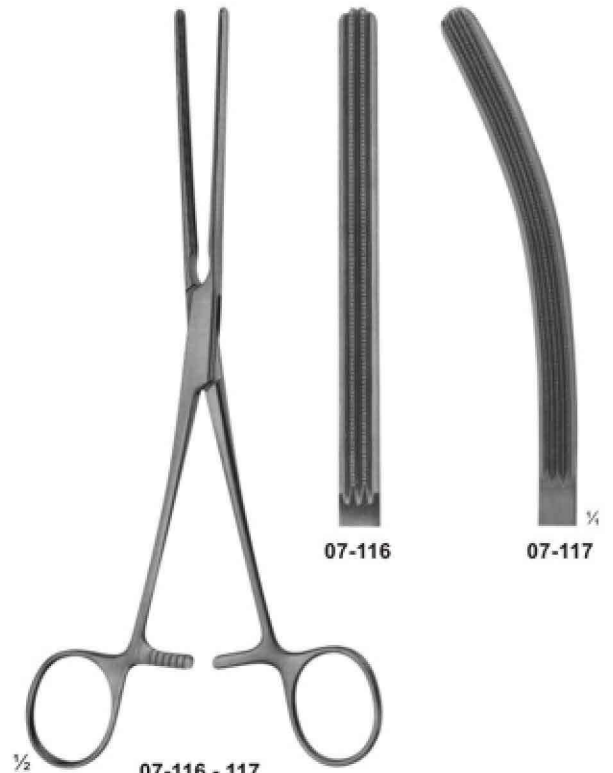

07-116 - 117
HARTMANN
with elastic blades
200 mm

Intestinal and Pylorus Clamps



½
07-118
 PAYR
 Intestinal clamp
 light pattern,
 for children
 180 mm

½
07-119
 PAYR
 200 mm

½
07-120
 PAYR
 275 mm

½
07-121
 PAYR
 Pylorus clamp
 315 mm

ATRAUMATA Sigmoid Anastomosis Forceps

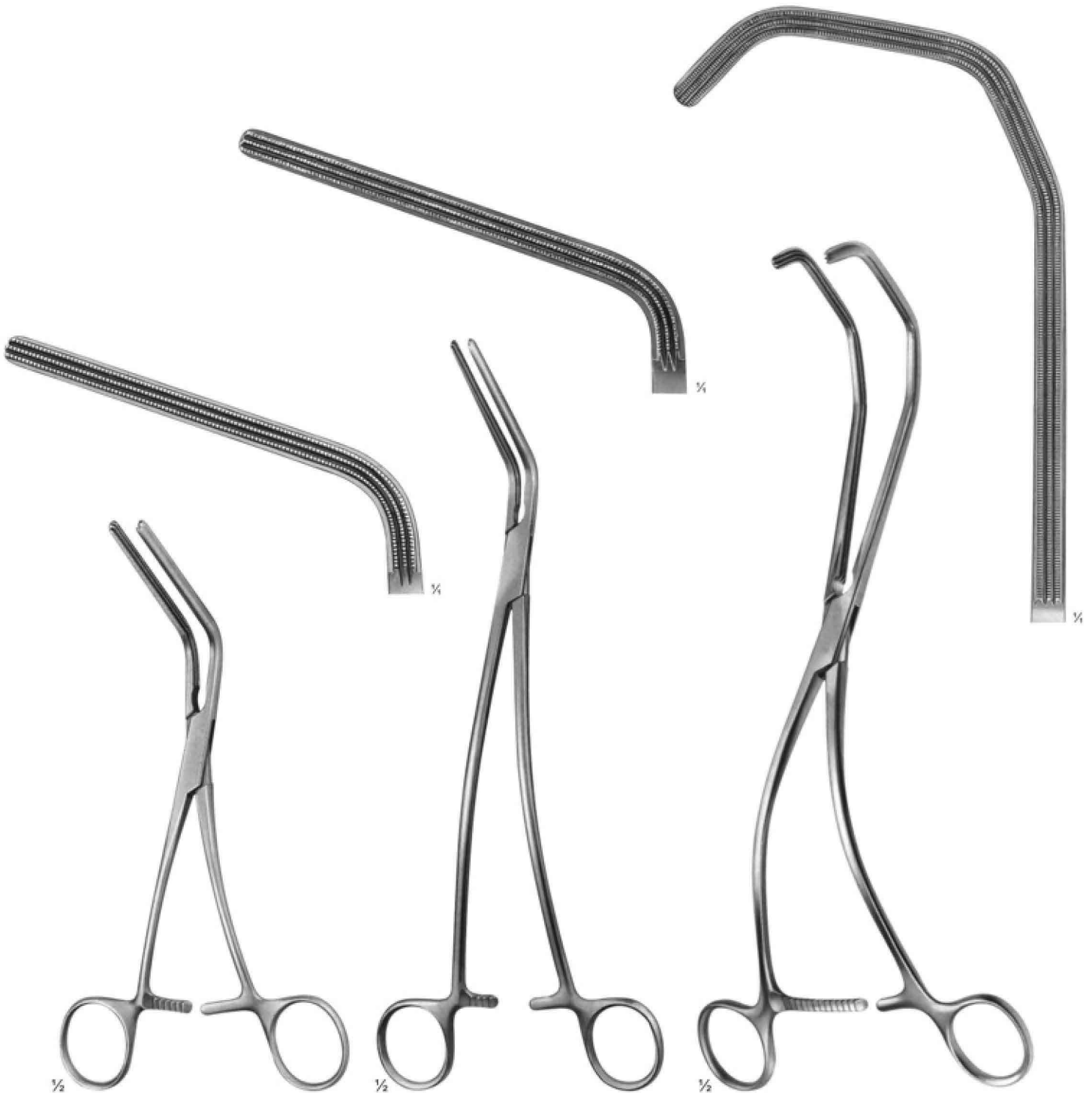

07-122
MORRIS
175 mm

07-123
DE BAKEY
(MORRIS modif.)
240 mm

07-124
KERSTING
270 mm

Nasal Specula



08-101
Martin
13 cm / 5 1/8"



08-102
SIMS
160 mm

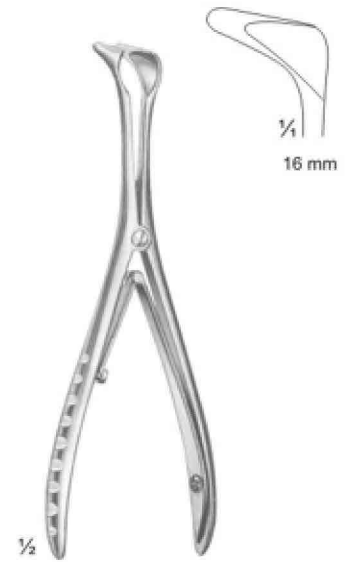

08-103
Tieck-Halle
13 cm / 5 1/8"



08-104
Killian

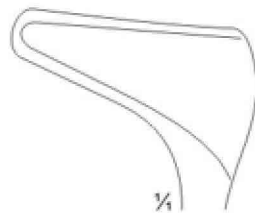

Fig. 1
14 cm 5 4/8"
35 mm

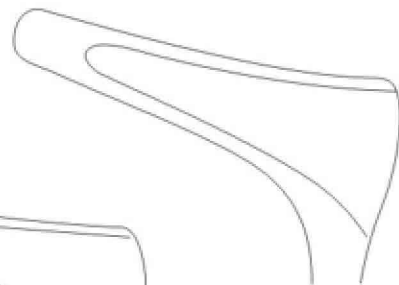

Fig. 2
14,5 cm / 5 4/8"
50 mm

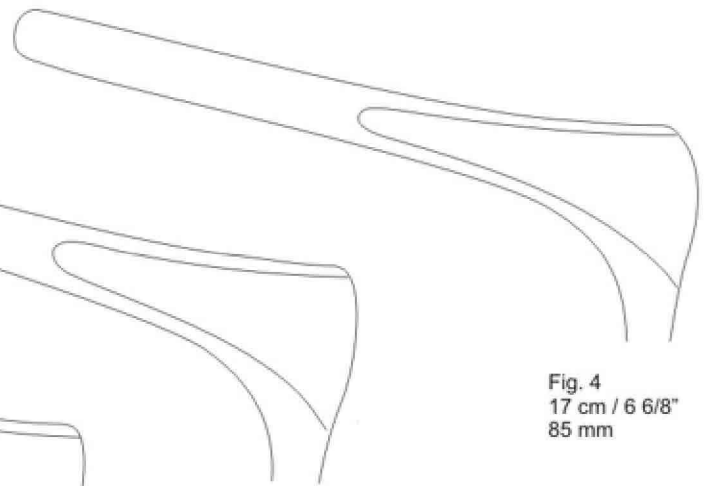

Fig. 3
16 cm / 6 2/8"
75 mm

Fig. 4
17 cm / 6 6/8"
85 mm

Nasal Specula



08-105
Cottle

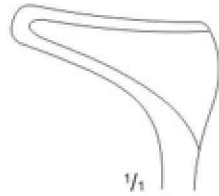

Fig. 1
13,5 cm / 5 3/8"
35 mm

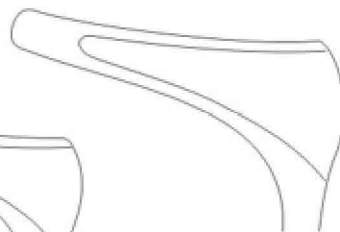

Fig. 2
14 cm / 5 4/8"
50 mm

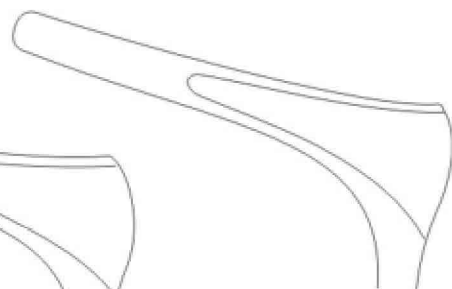

Fig. 3
16 cm / 6 2/8"
75 mm

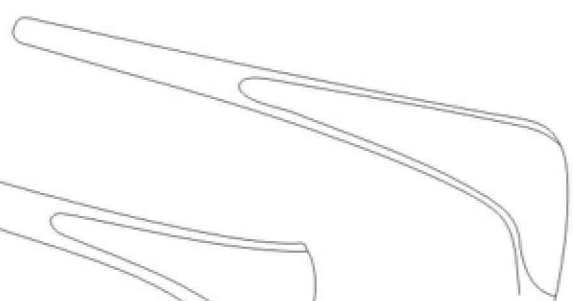

Fig. 4
16 cm / 6 2/8"
85 mm



08-106
Goldsmith (Thudichum)
6,5 cm / 2 4/8"



Fig. 1
21,0 x 9,5 mm



Fig. 2
21,0 x 10,5 mm



Fig. 3
21,0 x 11,5 mm



08-107
Mod. Wien 2
13,5 cm / 5 7/8"

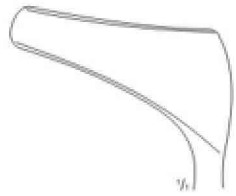

30 mm



08-108
Hartmann-Halle
16 cm / 6 7/8"



Fig. 1
27 mm



Fig. 2
31 mm

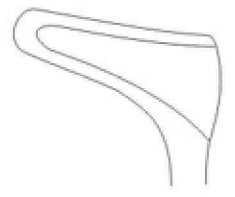

Fig. 3
35 mm

Anusopes-Sphincteroscopes



08-109
IVES-FANSLER
Anuscope
145 mm
Ø24mm



08-110
KELLY
Sphincteroscope
160 mm
Ø21mm



08-111
KELLY
Sphincteroscope
160 mm
Ø27mm

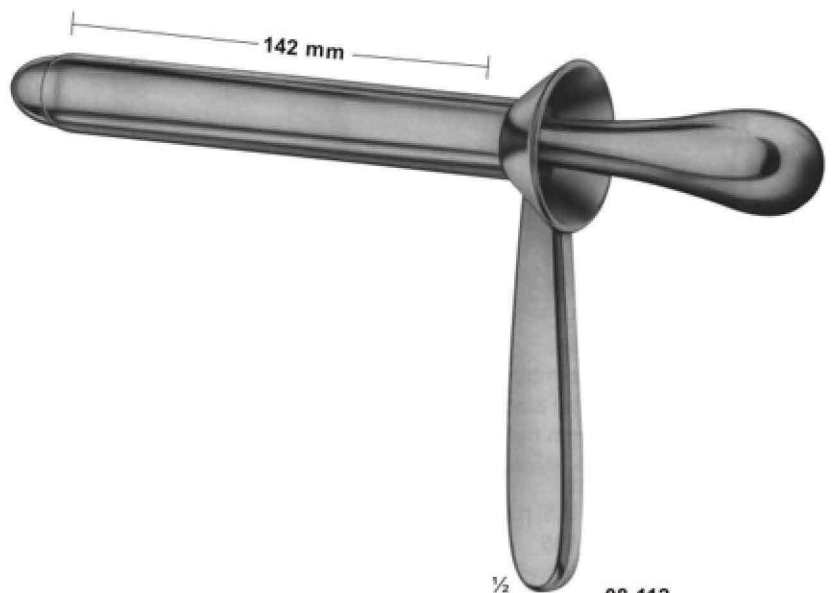

08-112
KELLY
Proctoscope
140 mm
Ø22mm

Haemorrhoidal Forceps

ATRAUMATA

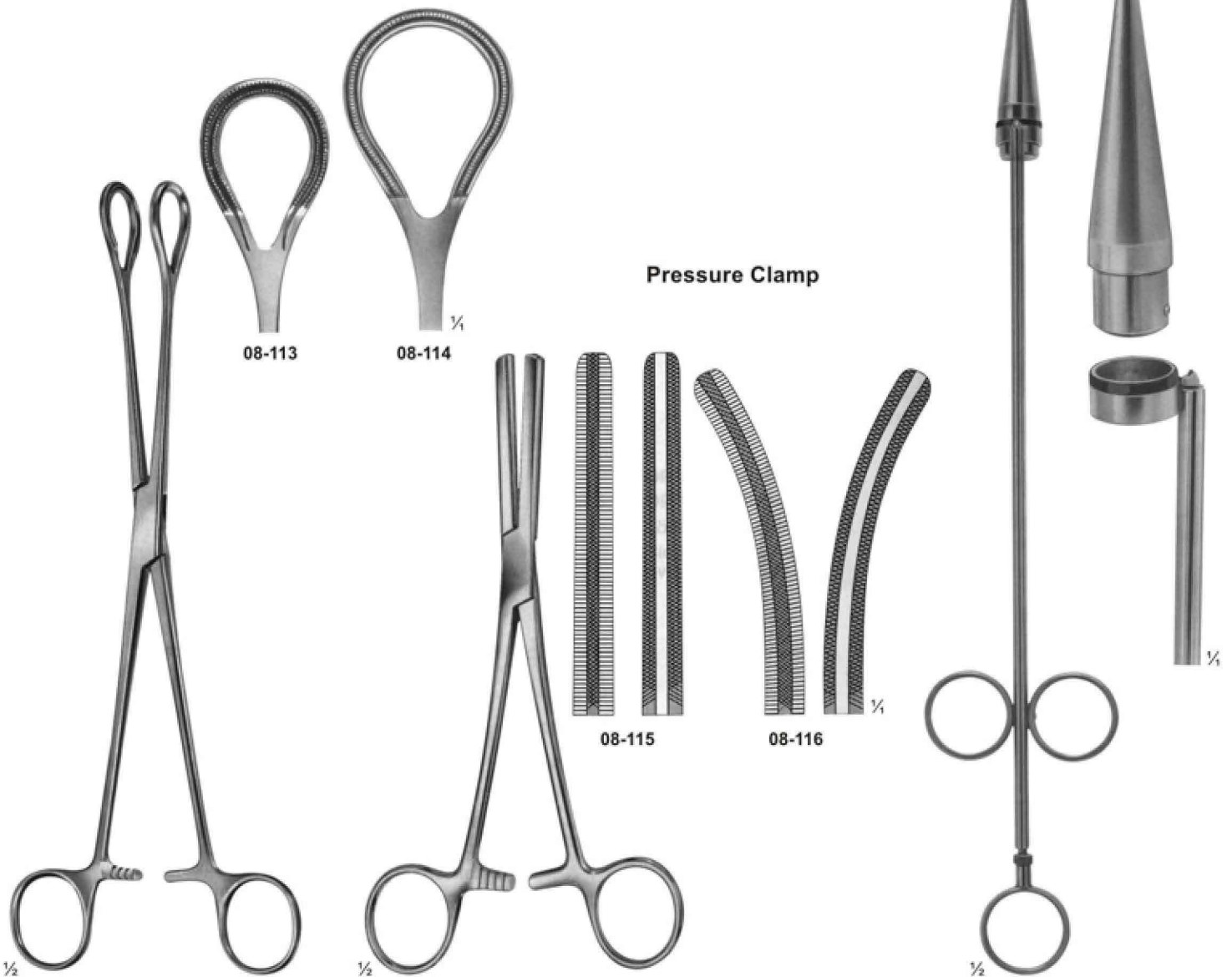

08-113 - 08-114
250 mm
08-114
270 mm

08-115 - 08-116
FERGUSSON
200 mm

08-117
RUDD
Haemorrhoidal ligator
with loading
attachment and 100
ligature rubber rings
315 mm

Gall Duct Forceps



08-118
LOWER
180 mm



08-119
LAHEY (SWEET)
190 mm

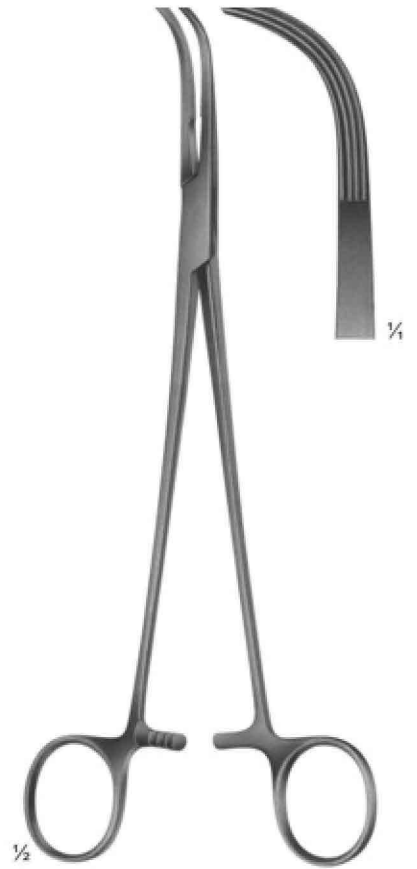

08-120
LAHEY
220 mm



08-121
DESJARDINS
Gall duct-and cystic forceps
210 mm



08-122
NISSEN
Gall duct-and cystic forceps
215 mm

Gall Duct Dilators and Gall Stone Scoops

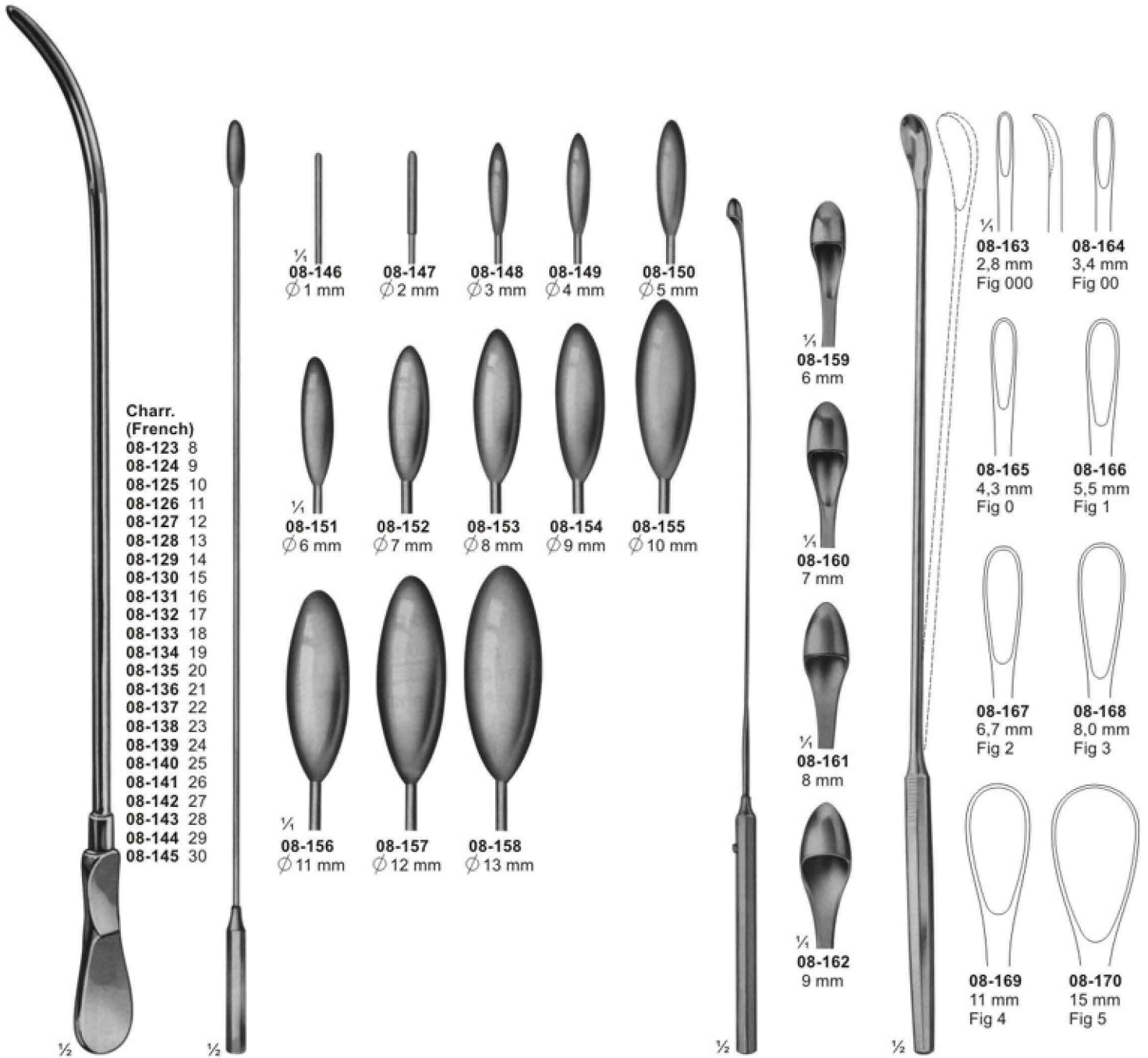

08-123 - 08-145
 DITTEL
 Metall bougies and dilating sounds, stiff
 345 mm

08-146 - 08-158
 BAKES
 Common bile duct dilators, malleable
 08-146 - 08-150 315 mm
 08-151 - 08-158 320 mm

08-159 - 08-162
 DESJARDINS
 Probe and catch with flexible shaft
 300 mm

08-163 - 08-170
 LUER-KOERTE modif
 with malleable shaft
 310 mm

Gall Stone Forceps

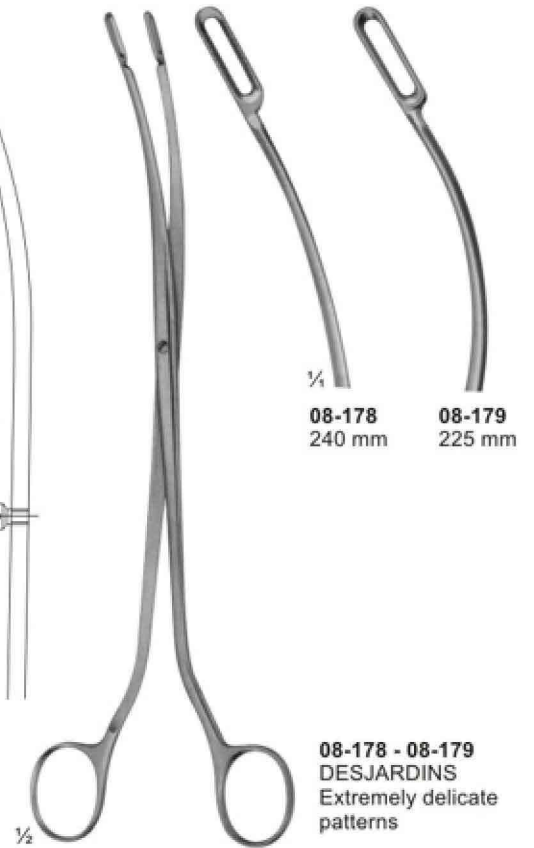
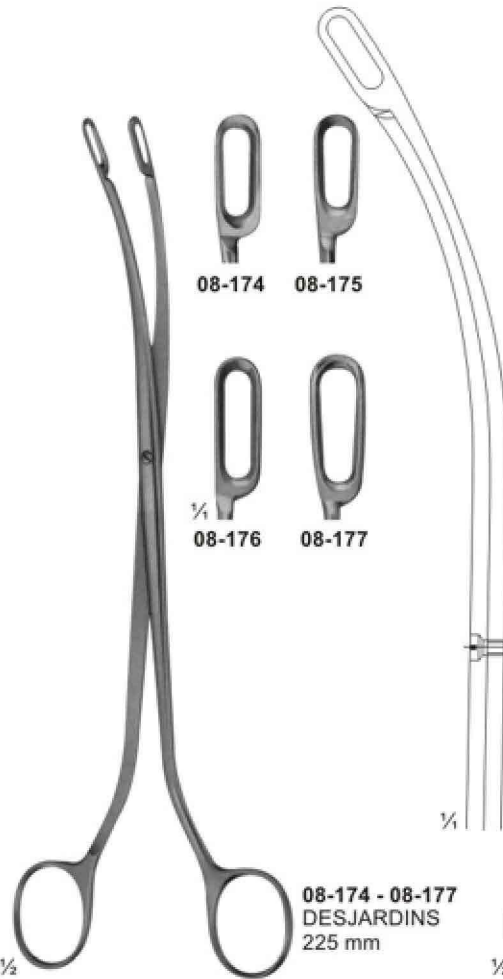
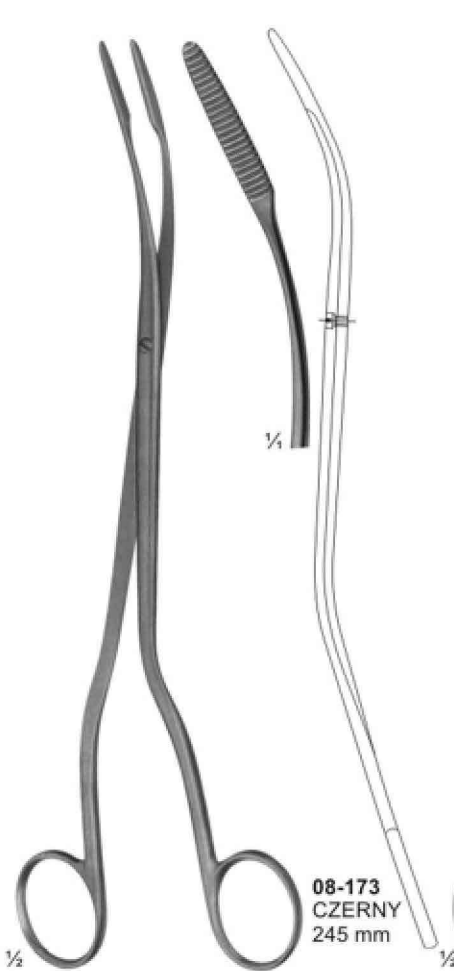
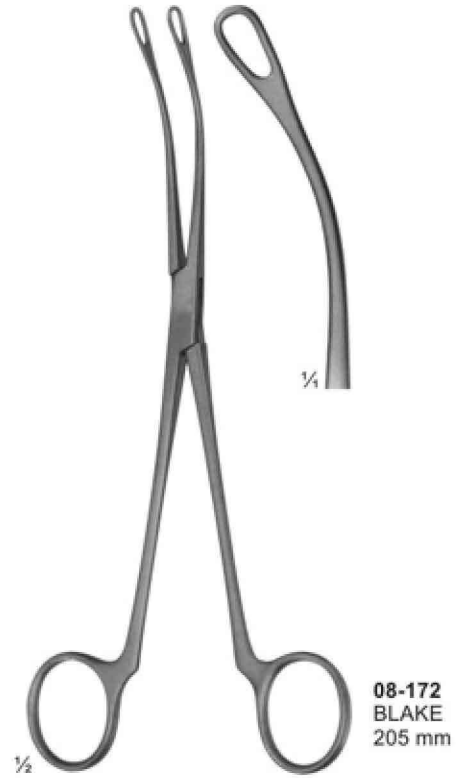

Kidney Clamps

ATRAUMATA

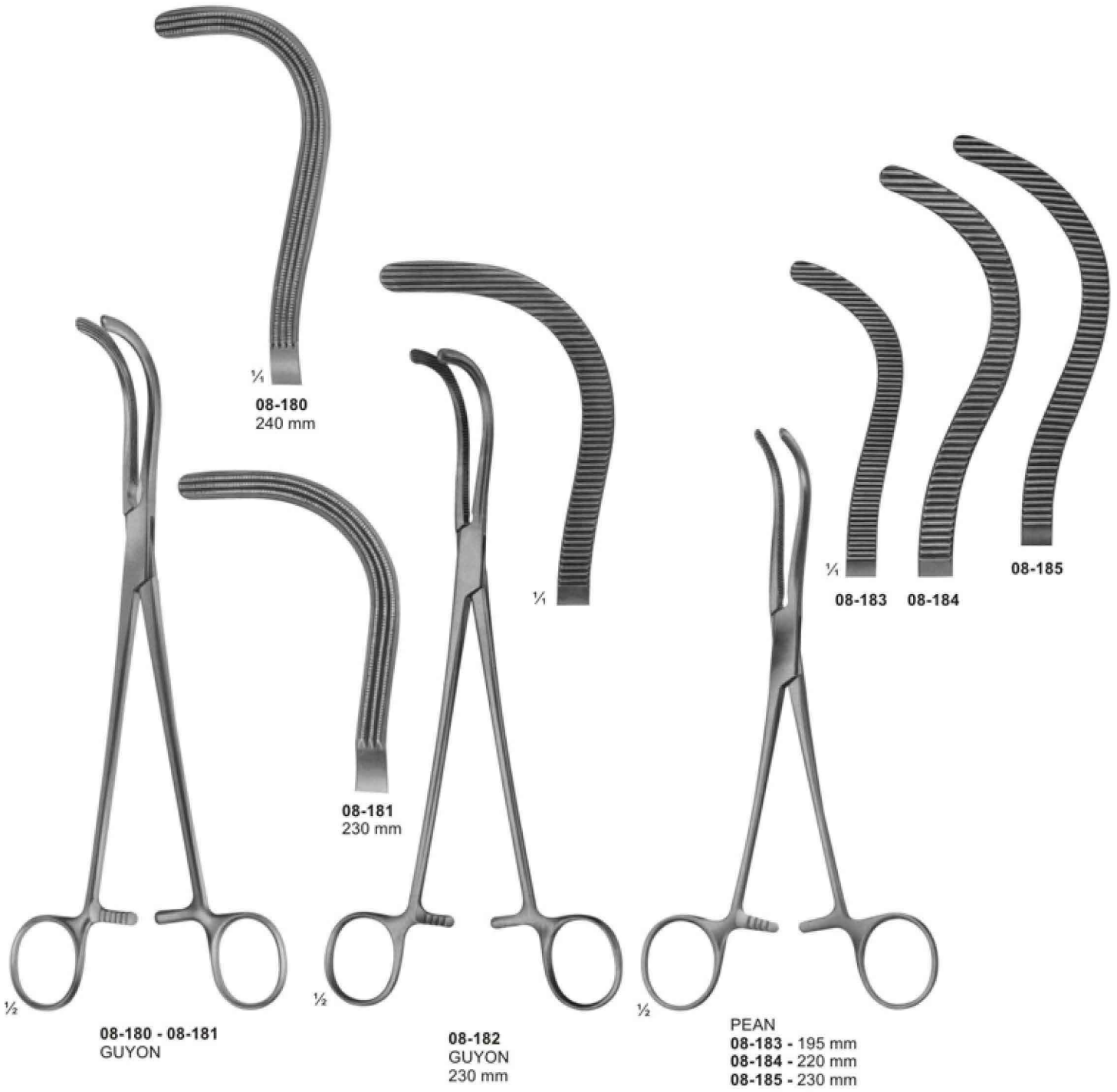

Kidney Stone Forceps



08-186



08-187



08-188



1/4
08-189

1/2

08-186 - 08-189
RANDALL
225 mm



08-190



08-191



1/4
08-192

1/2

08-190 - 08-192
RANDALL
190 mm

Bladder Retractors

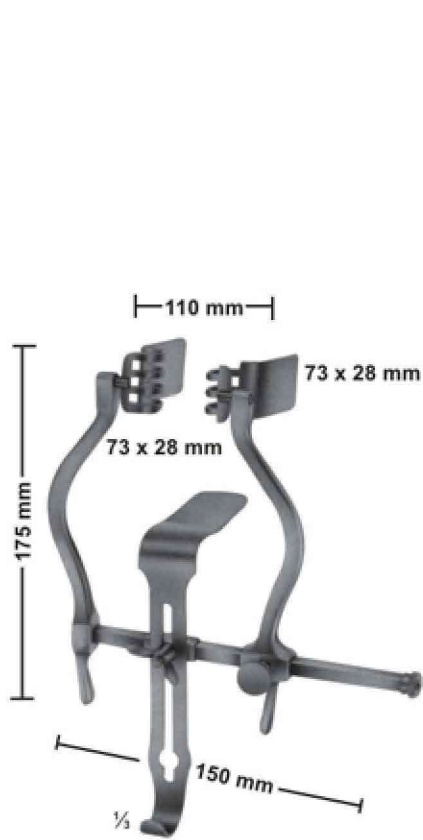

09-101
JUDD-MASSON
 Bladder and suprapubic retractor

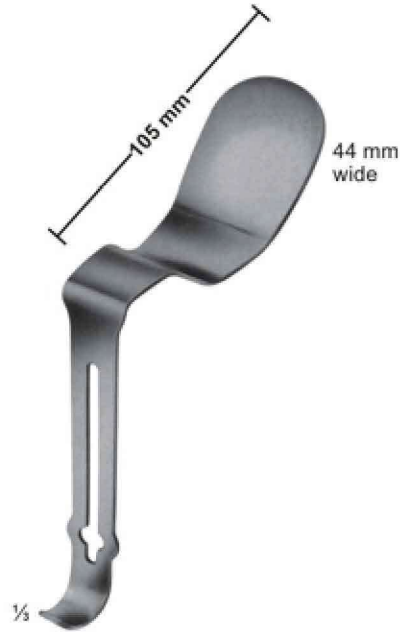

09-102
MILLIN
 Center bladder for retro pubic prostatectomy



09-103
MILLIN
 Bladder retractor, complete
 105X45 mm



09-104
LEGUEU
 Bladder retractor
 Center blade
 80 x 31 mm



09-105
KOCHER
 Bladder spatula
 235 mm

Trocars



09-106
KLIMA ROSEGGER
35 X 1,8 mm
Sternal puncture needle



09-107
Universal trocar
with 4 tips



NELSON



09-108 - 112
Inside diam. Outside diam
09-108 2,2 mm 3,0 mm
09-109 3,0 mm 4,0 mm
09-110 4,0 mm 5,0 mm
09-111 5,0 mm 6,0 mm
09-112 5,5 mm 6,5 mm
for hydrocele and abdominal puncture

09-113 - 116
Inside dime. Outside dime
09-113 2,2 mm 3,0 mm
09-114 3,0 mm 4,0 mm
09-115 4,0 mm 5,0 mm
09-116 5,0 mm 6,0 mm
for abdominal puncture,
with stop-cock and lateral drain



09-117 - 118
Inside diam. Outside diam
09-117 6,5 mm 8,0 mm
09-118 9,0 mm 10,0 mm
Empyema trocar
BUELEU

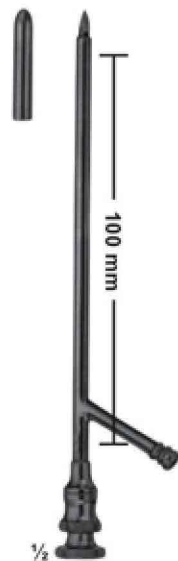

09-119 - 122
Inside diam. Outside diam
09-119 3,0 mm 4,0 mm
09-120 3,6 mm 4,6 mm
09-121 4,3 mm 5,3 mm
09-122 5,0 mm 6,0 mm
Gall bladder trocars. OCHSNER



09-123
PIERCE
Antrum trocar
Ø 4,0 mm



09-124
COAKLEY
Antrum trocar
3,0 mm

Vaginal Specula

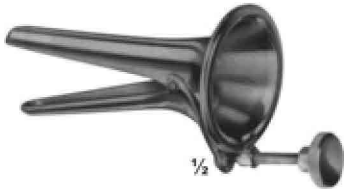

10-101
COLLIN
for children
53 x 10 mm

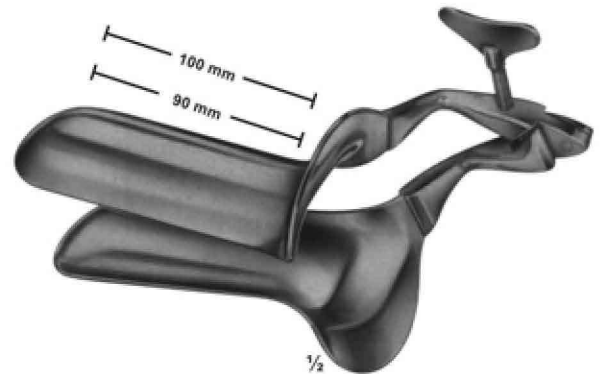

10-102 - 105
COLLIN

10-102	100/90mm	28 mm
10-103	100/90mm	32 mm
10-104	105/95mm	35 mm
10-105	115/105mm	40 mm
Total length/working length		width



10-106
COLLIN
for virgins
95/85 x 18 mm



10-107
CUSCO
for virgins
75 x 17 mm



10-108
CUSCO
for virgins
75 x 17 mm

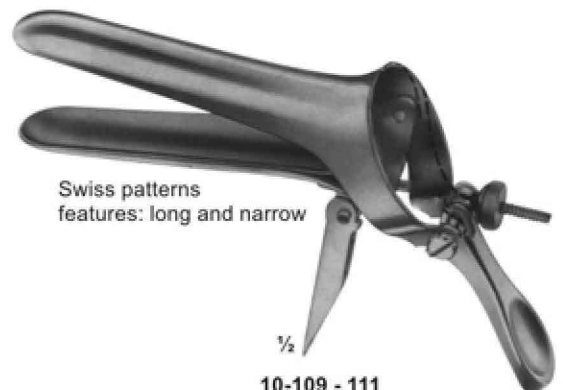

Swiss patterns
features: long and narrow

10-109 - 111
CUSCO

10-109	92X23-25 mm
10-110	100x25-27 mm
10-111	110x27-30 mm

Vaginal Specula- Sets, upper and lower blades



10-112 - 114
GRAVE
10-112 75X20 mm
10-113 95X30 mm
10-114 105X33 mm

½



10-115 - 116
PEDERSON
10-115 100X22 mm
10-116 120X25 mm

½



10-117 - 118
BRIESKY
10-117 72X25 mm / 77X30 mm 140 mm
10-118 75X30 mm / 92X38 mm 170 mm

½



10-119
SIMS
70 X 26 mm / 75 X 30 mm
75 X 30 mm / 80 X 35 mm
80 X 36 mm / 90 X 40 mm
175 mm

½

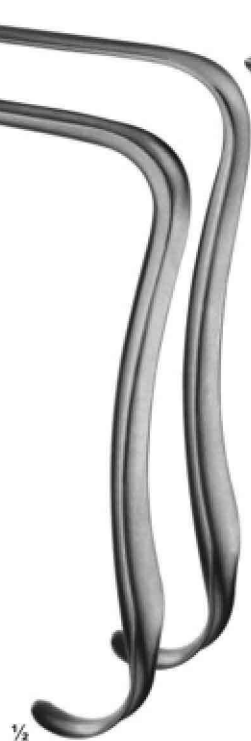

10-120 - 122
SEIDL
10-120 80X8 mm
10-121 80X10 mm
10-122 90X14 mm
For children and infants
170 mm

½



10-123
KRISTELLER
70X15 mm, (170 mm)
For children

½



10-124 - 10-126
KRISTELLER
10-124 70X27 mm
10-125 75X30 mm
10-126 90X36 mm
175 mm

½

Vaginal Specula- upper and lower blades



10-127 - 131
KRISTELLER
10-127 110X18 mm
10-128 110X20 mm
10-129 110X27 mm
10-130 110X30 mm
10-131 110X36 mm
 220 mm

10-132 - 10-135
KRISTELLER
 Upper blades

10-136 - 10-139
KRISTELLER
 Lower blades

Vaginal Specula



10-140
60 X 45 mm

10-141
90 X 45 mm

10-142
112 X 45 mm

10-140 - 143
DOYEN
235 mm

10-143 - 10-153
DOYEN
240 mm

	width of blades		
	35 mm	45 mm	60 mm
length of blades	60 mm	45 mm	60 mm
	90 mm	10-143	10-146
	120 mm	10-144	10-147
	160 mm	10-145	10-148
		10-149	10-153

Vaginal Retractors



1/2
10-154
JOLL (FRIEDMAN)
155 mm



1/2
10-155
RICHTER
170 mm



1/2
10-156
GELPI
135 mm



1/2
10-157
GELPI
175 mm

Uterine Dilators



11-101	1	mm	11-123	23	mm
11-102	2	mm	11-124	24	mm
11-103	3	mm	11-125	25	mm
11-104	4	mm	11-126	26	mm
11-105	5	mm	11-127	1	1/2mm
11-106	6	mm	11-128	2	1/2mm
11-107	7	mm	11-129	3	1/2mm
11-108	8	mm	11-130	4	1/2mm
11-109	9	mm	11-131	5	1/2mm
11-110	10	mm	11-132	6	1/2mm
11-111	11	mm	11-133	7	1/2mm
11-112	12	mm	11-134	8	1/2mm
11-113	13	mm	11-135	9	1/2mm
11-114	14	mm	11-136	10	1/2mm
11-115	15	mm	11-137	11	1/2mm
11-116	16	mm	11-138	12	1/2mm
11-117	17	mm	11-139	13	1/2mm
11-118	18	mm	11-140	14	1/2mm
11-119	19	mm	11-141	15	1/2mm
11-120	20	mm	11-142	16	1/2mm
11-121	21	mm	11-143	17	1/2mm
11-122	22	mm			

11-101 - 143
HEGAR
with very conical point
185 mm



11-144	1+2	mm
11-145	3+4	mm
11-146	5+6	mm
11-147	7+8	mm
11-148	9+10	mm
11-149	11+12	mm
11-150	13+14	mm
11-151	15+16	mm
11-152	17+18	mm

11-144 - 152
HEGAR
205 mm

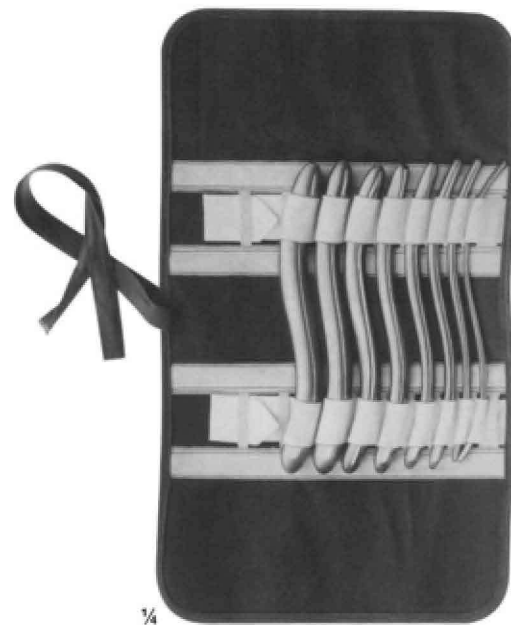

11-153
HEGAR
Uterine dilator set, in canvas
roll with 8 dilators.

Uterine Probes

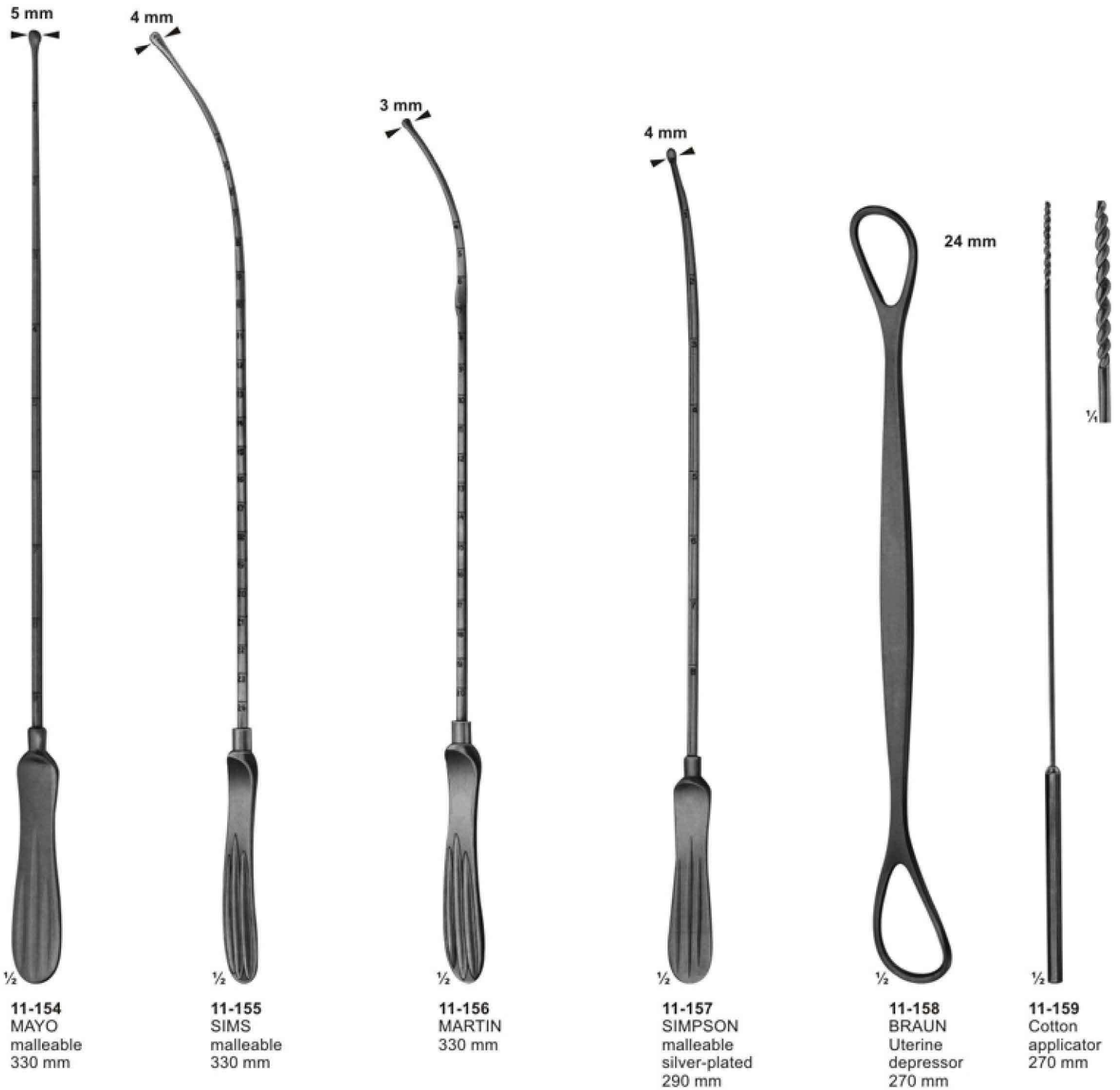

Uterine Dressing Forceps



11-160
PELMANN
260 mm



11-161
PELMANN
260 mm

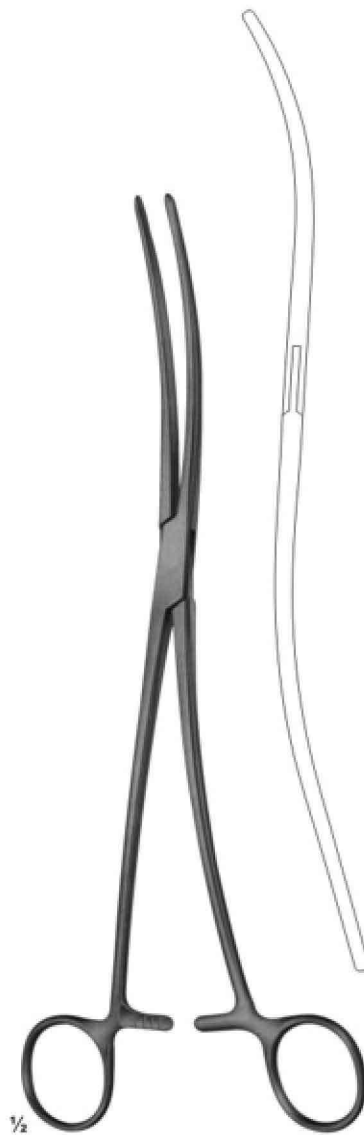

11-162
BOZEMANN
250 mm



11-163
BOZEMANN
255 mm

Jaws with longitudinal groove

Polypus-and Ovum Forceps

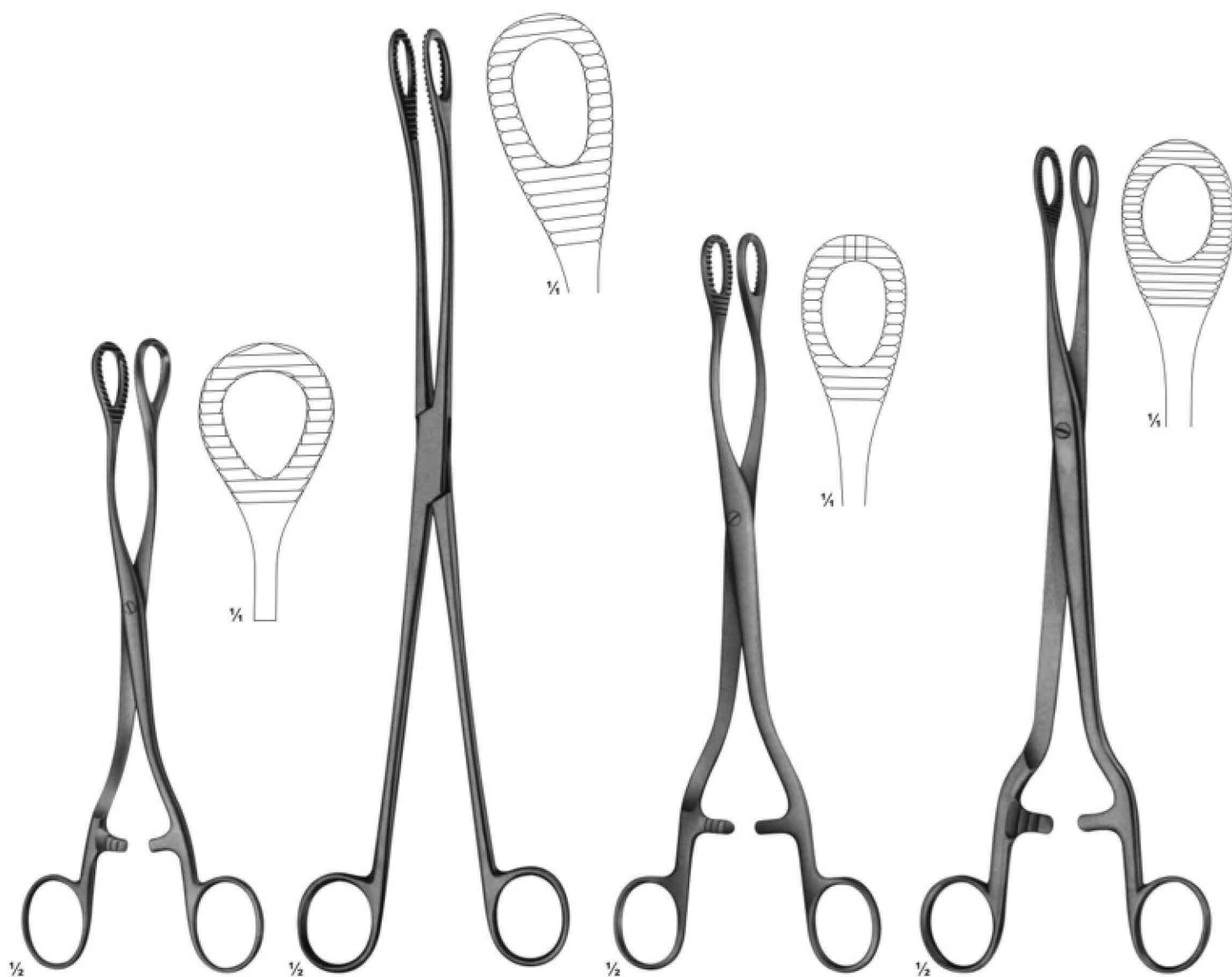

11-164
HEYWOOD-SMITH
200 mm

11-165
KELLY
320 mm

11-166
HEYWOOD-SMITH
250 mm

11-167
NOTO
280 mm

Ear Curettes



12-101
Langenbeck
13 cm / 5 1/8"

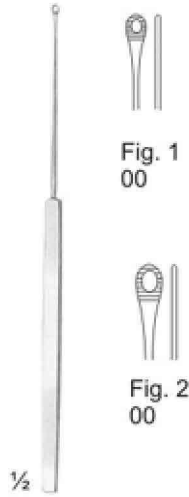

12-102
Shapleigh
15 cm / 5 1/8"

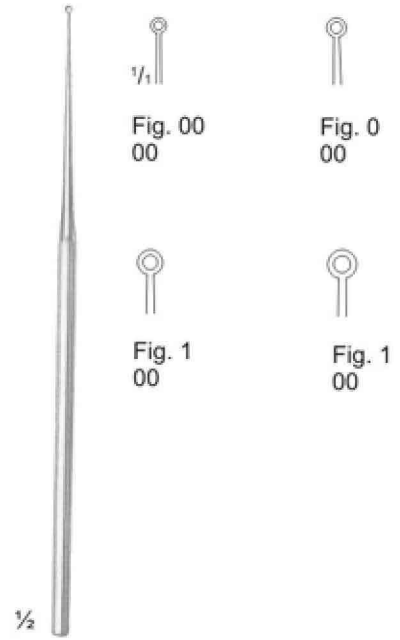

12-103
Buck
17cm / 6 6/8"

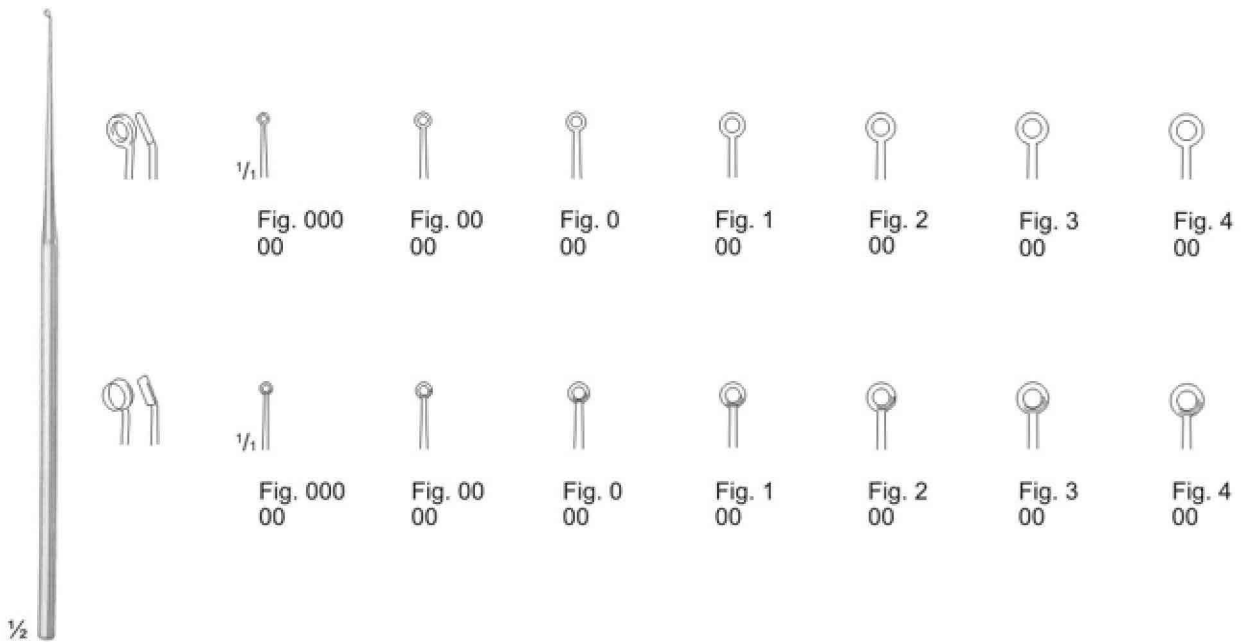

12-104
Buck
15 cm / 6 6/8"

Biopsy Currettes

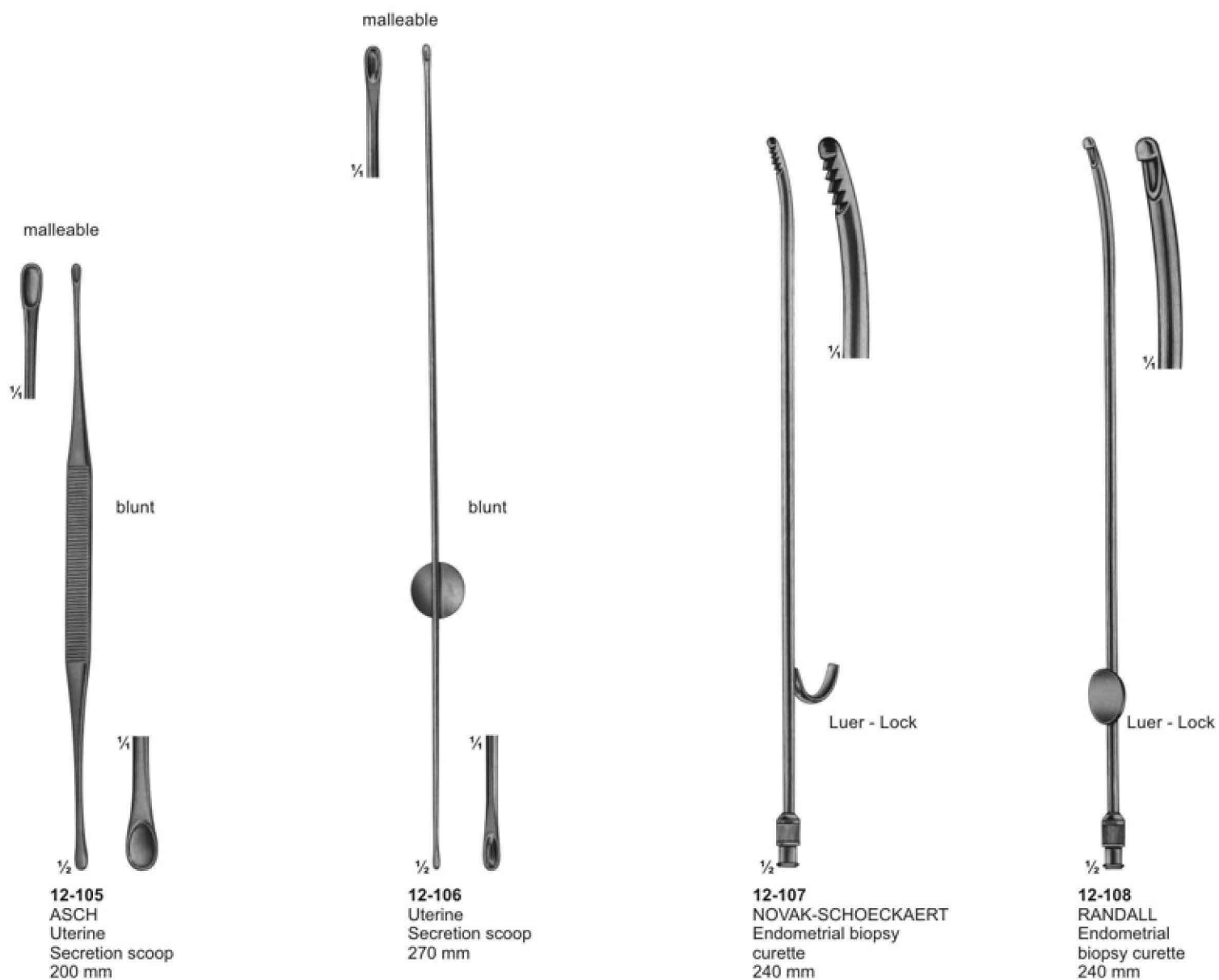

Ear Polypus Forceps



12-109
Hartmann-Wullstein
shaft length
85 mm

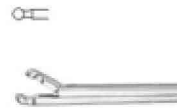

12-110
Hartmann-Wullstein
shaft length
85 mm



12-111
Hartmann
shaft length
85 mm



12-112
Hartmann
shaft length
85 mm

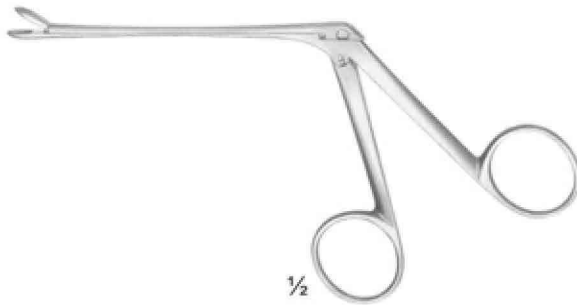

12-109 - 12-119

12-113
14 cm / 5 4/8"
shaft length
140 mm



12-114
Hartmann-Herzfeil
2,0 mm
shaft length
85mm



12-115
Hartmann
3 mm
shaft length
85mm

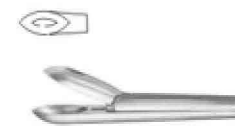

12-116
shaft length
85mm

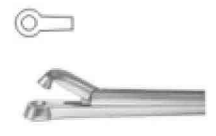

12-117
Hartmann-Hoffmar
2,0 mm
85mm

12-118
2,5 mm
85 mm

12-119
3,0 mm
85 mm

Biopsy forceps for rectum

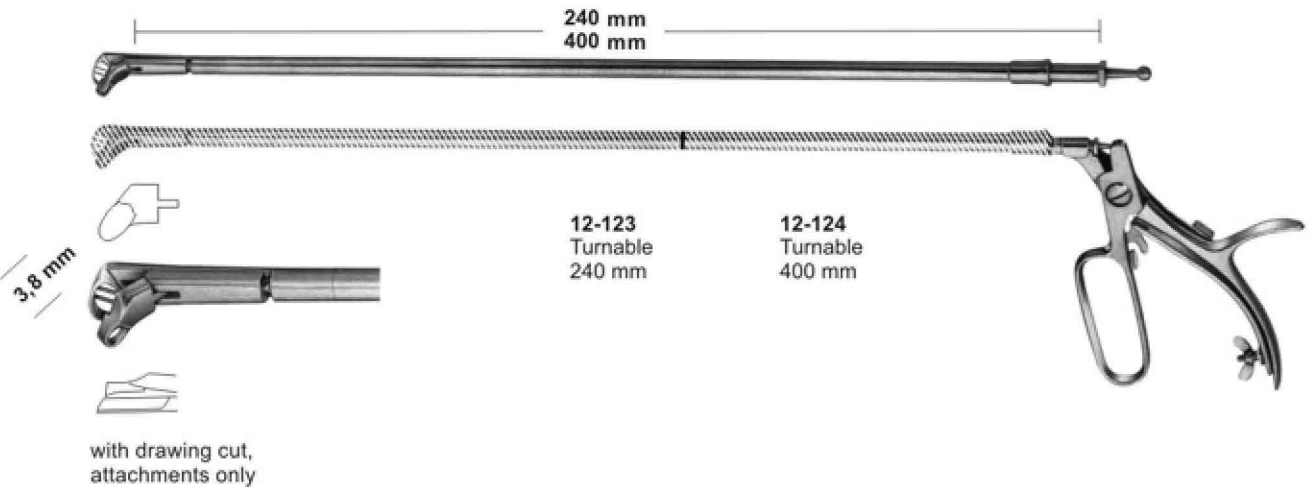
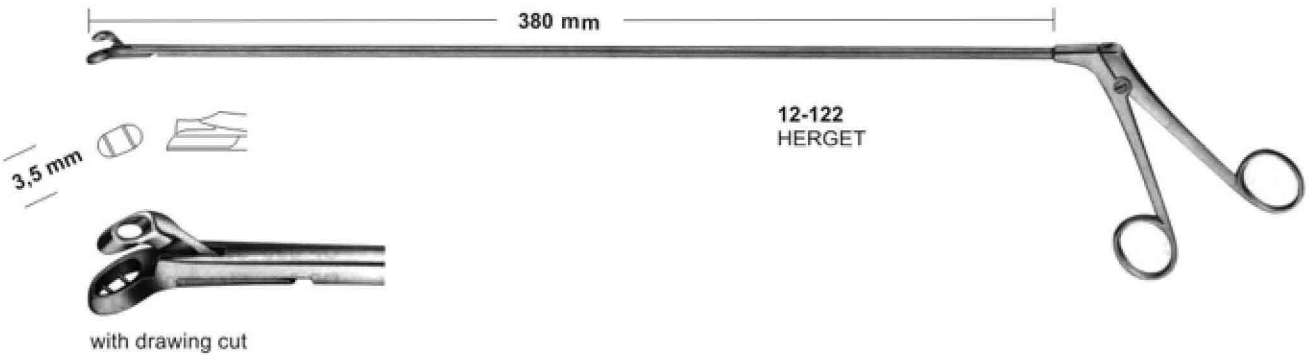
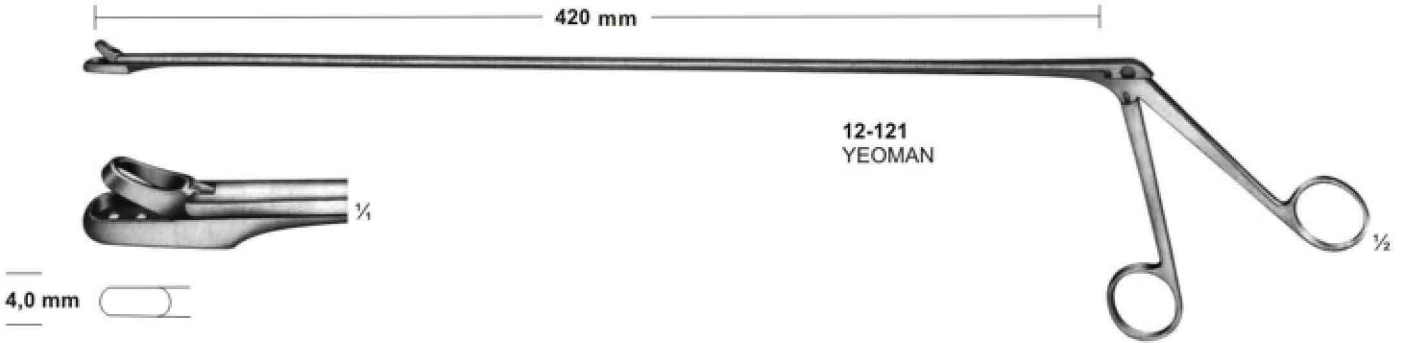
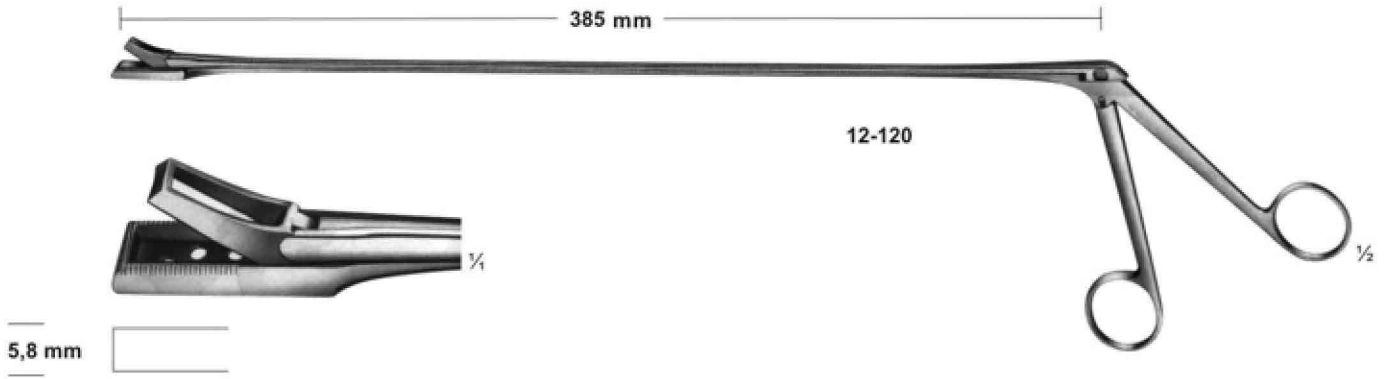

Biopsy Forceps

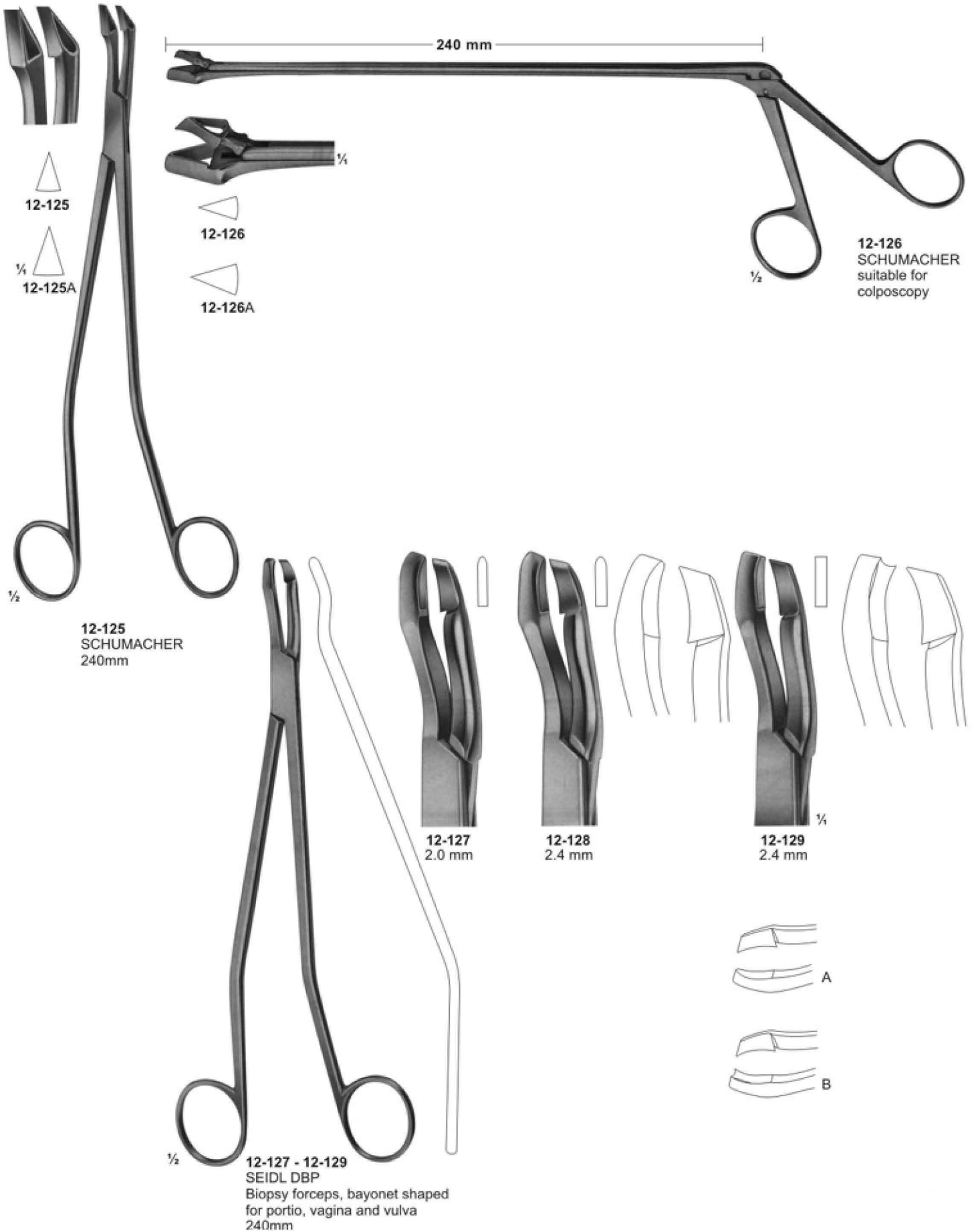

Biopsy Forceps

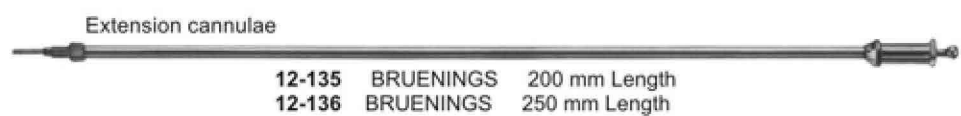
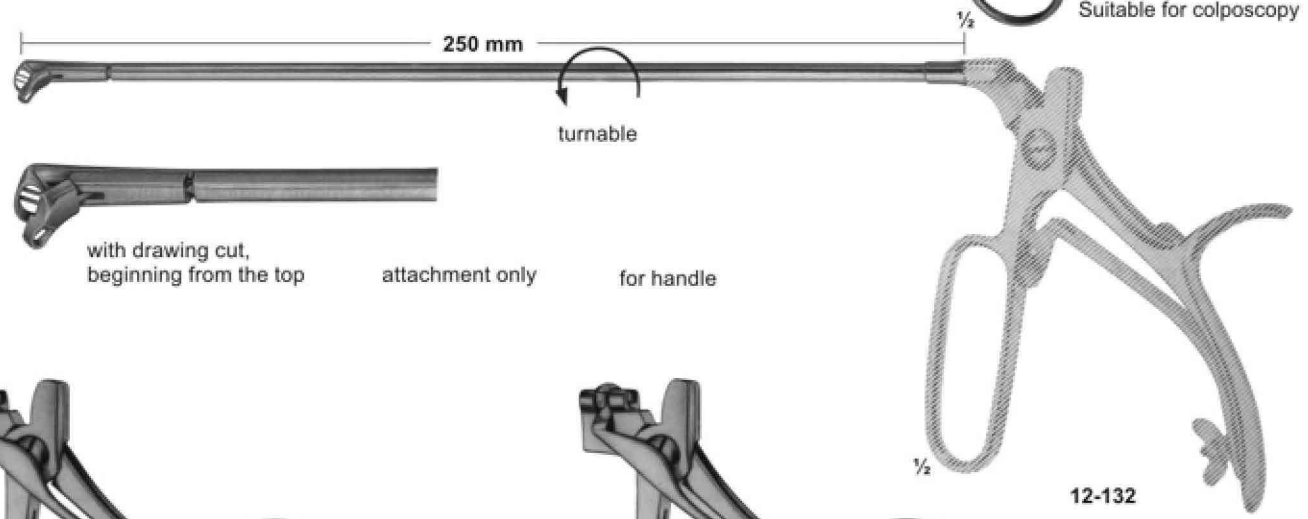
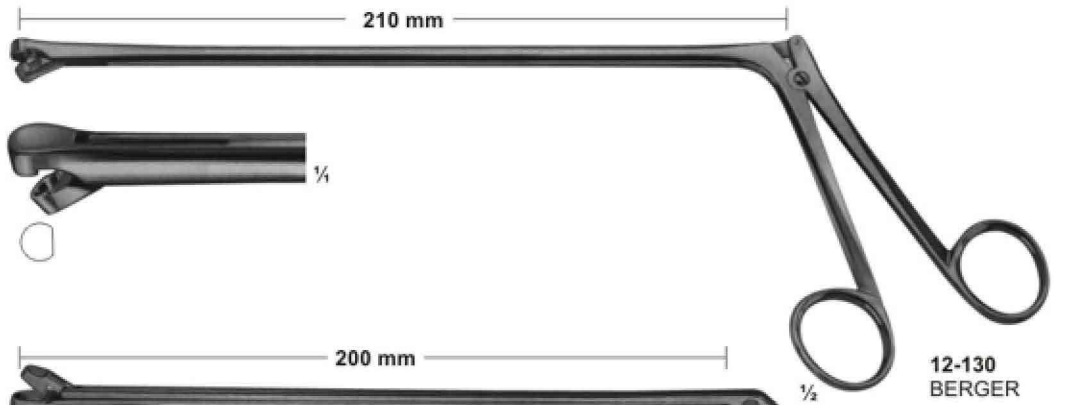

Uterine Scoops

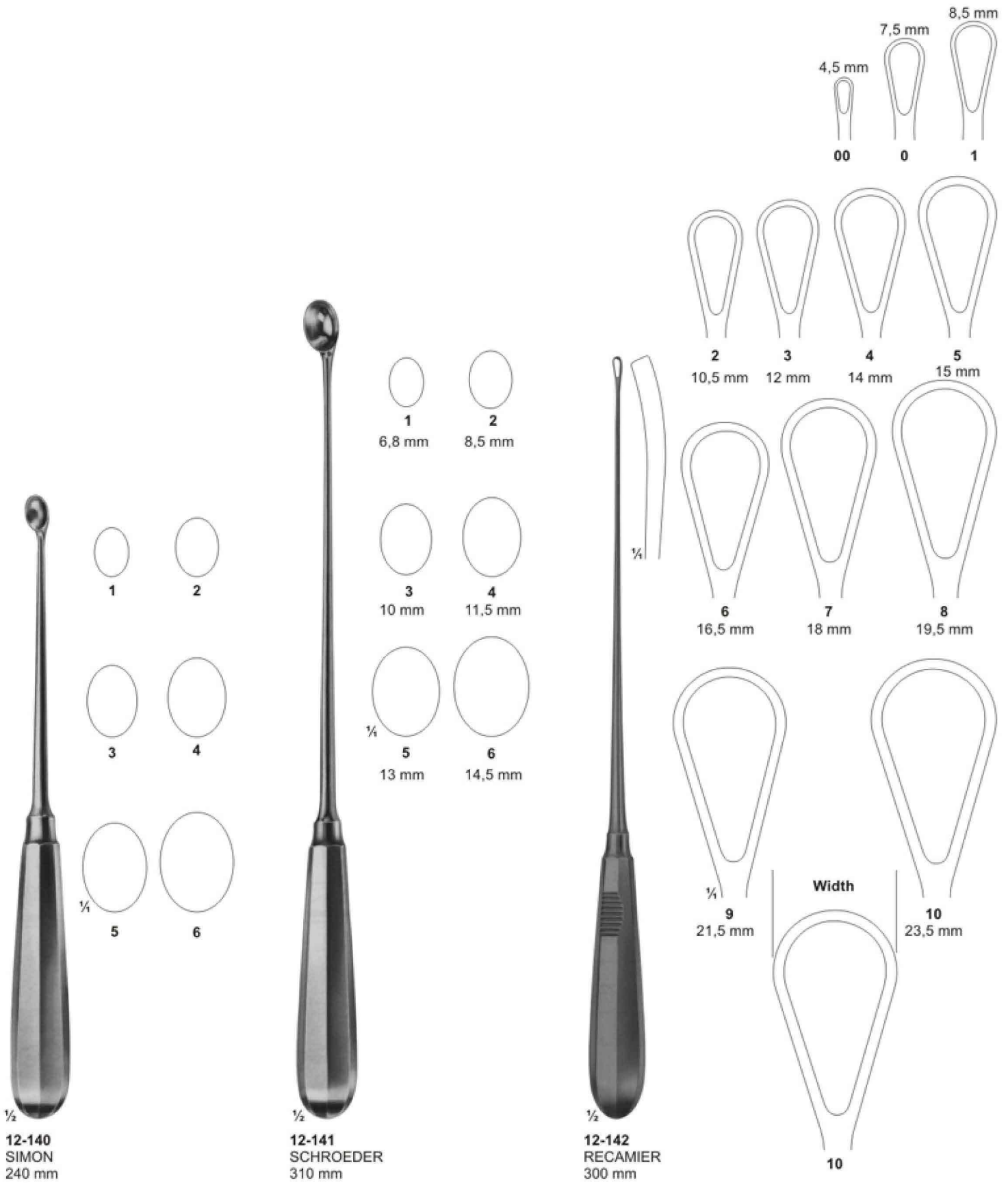

Obstetrical Forceps

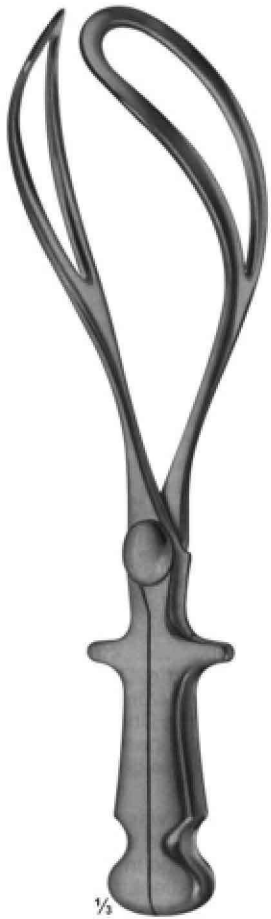

13-101
NAEGELE
355 mm



13-102
NAEGELE
400 mm



13-103
SIMPSON-BRAUN
305mm

Obstetrics- Placenta and Ovum Forceps

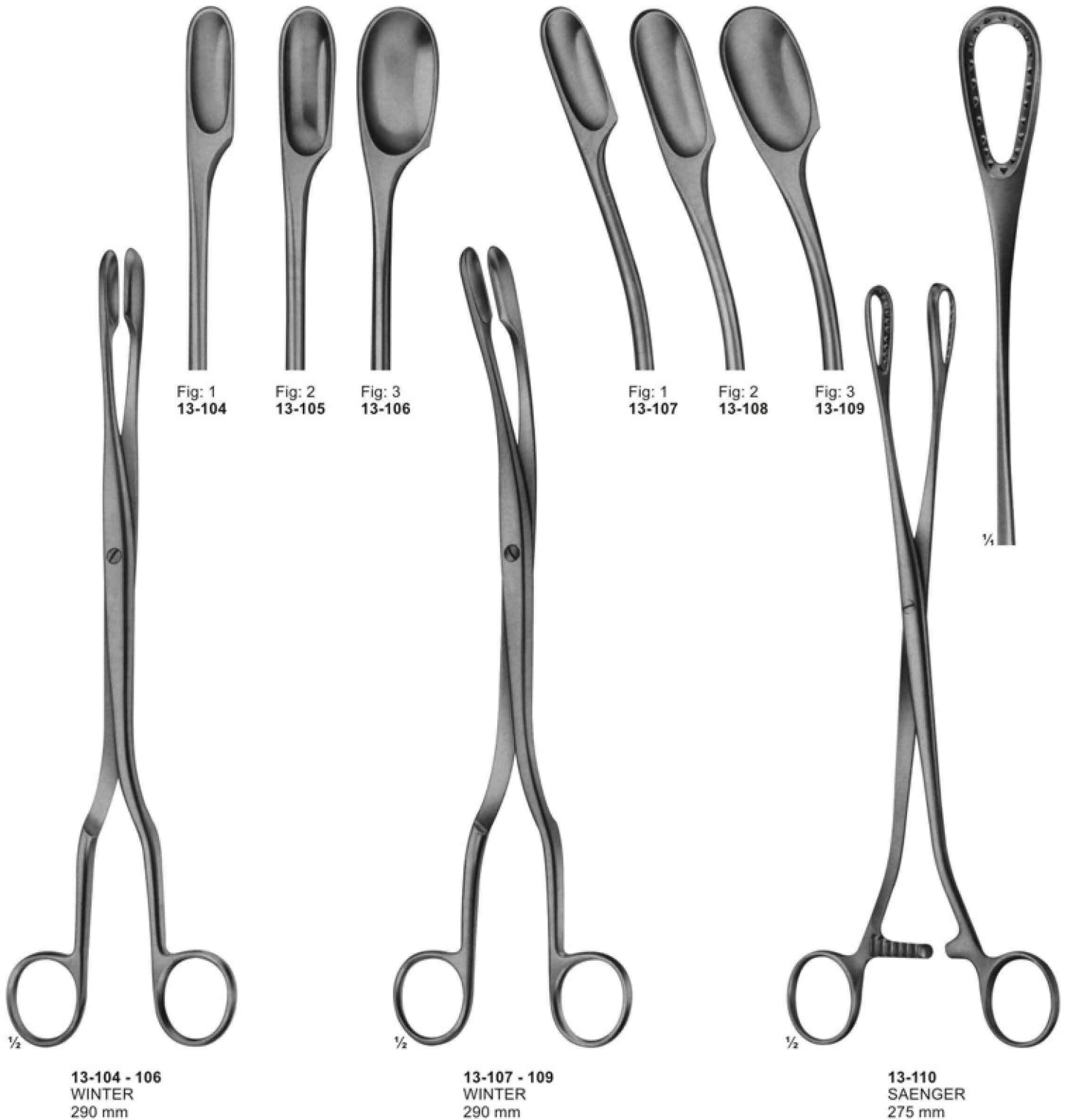

Tound-and Tracheal Hooks and Dilators

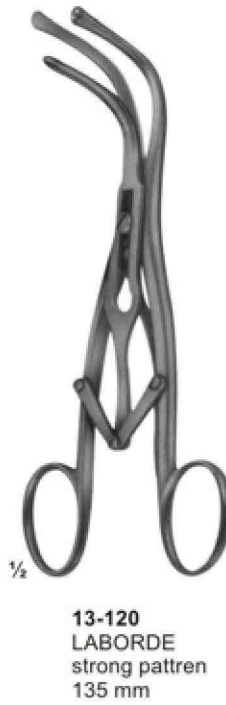
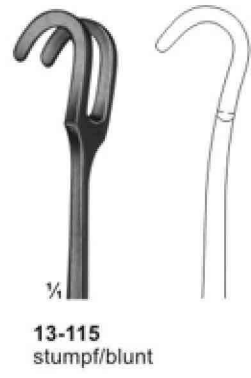
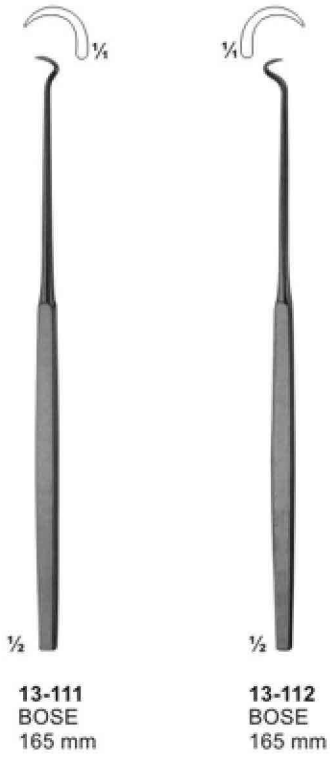

Vascular Spatulas

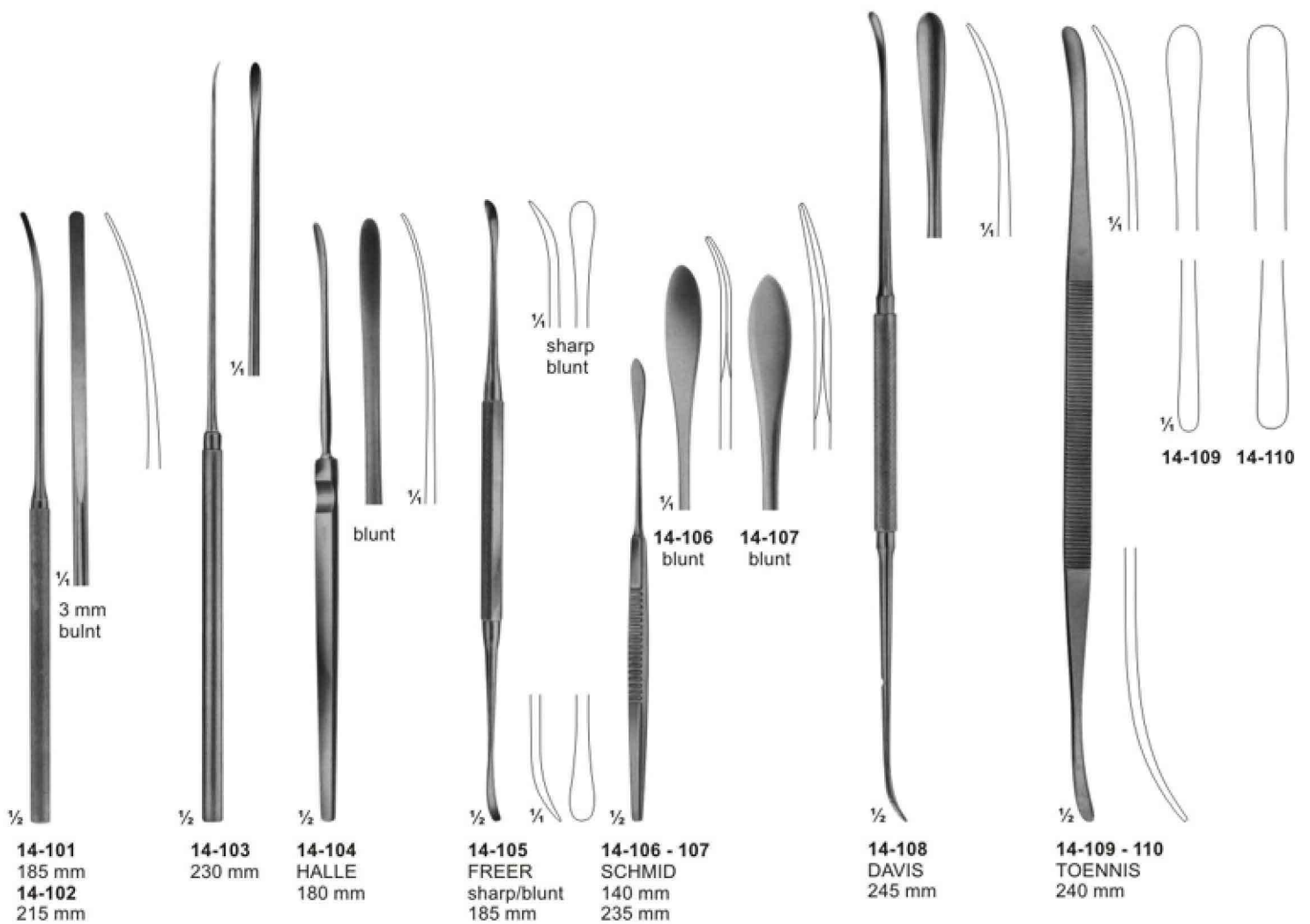

ATRAUMATA Forceps

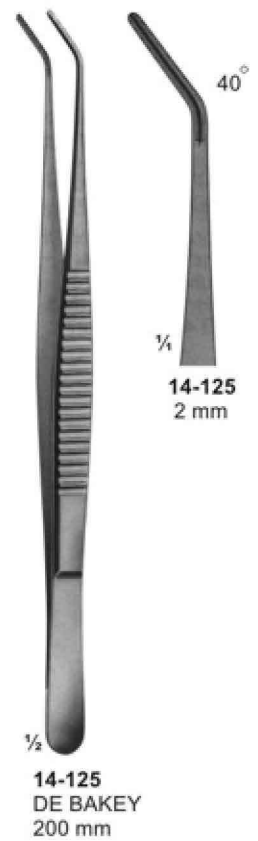
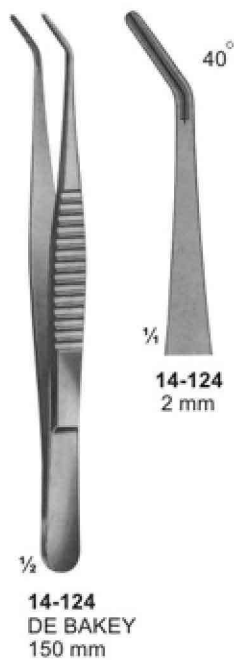
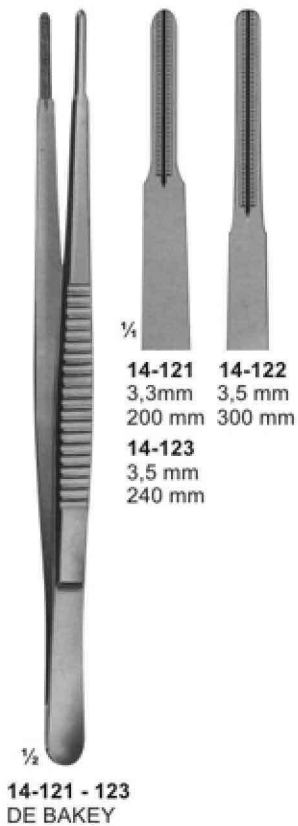
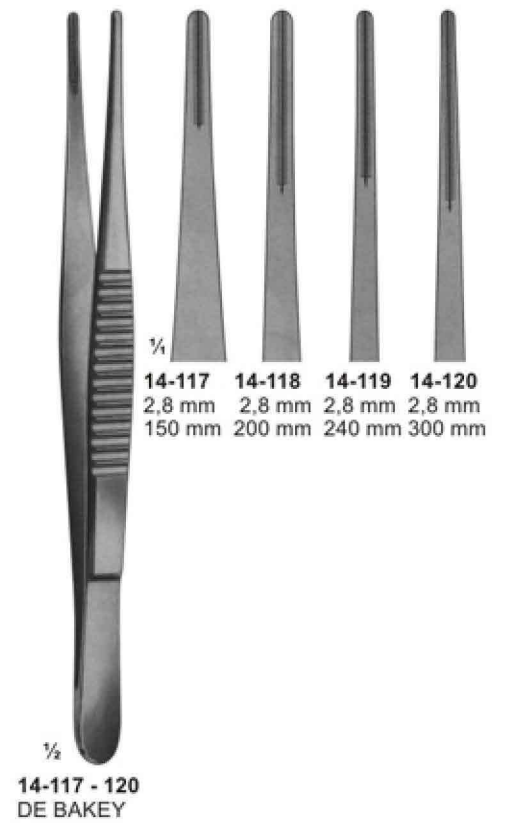
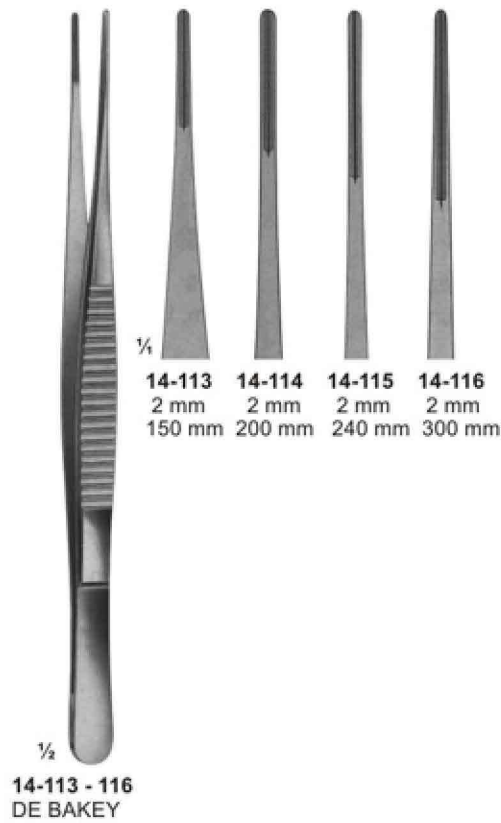
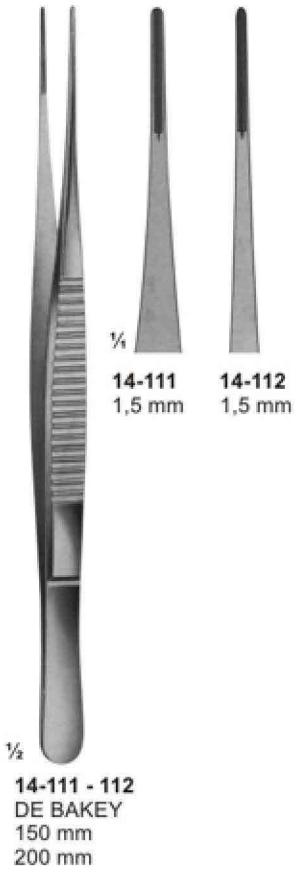

ATRAUMATA

Anastomosis- and Multi- Purpose- Clamps- Pediatric type

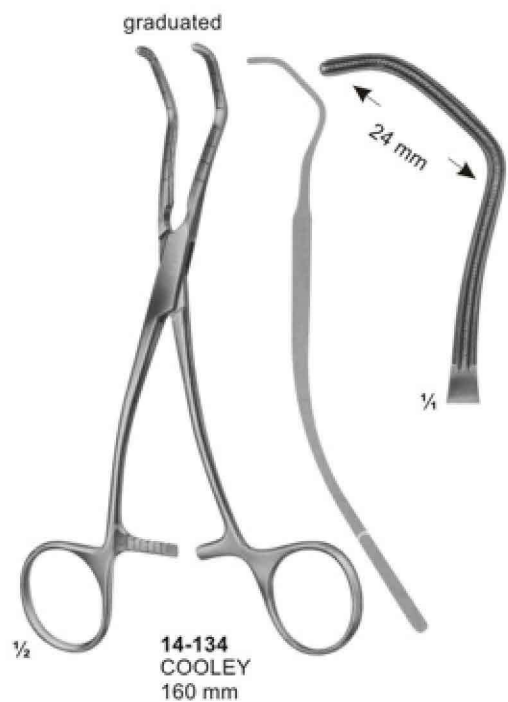
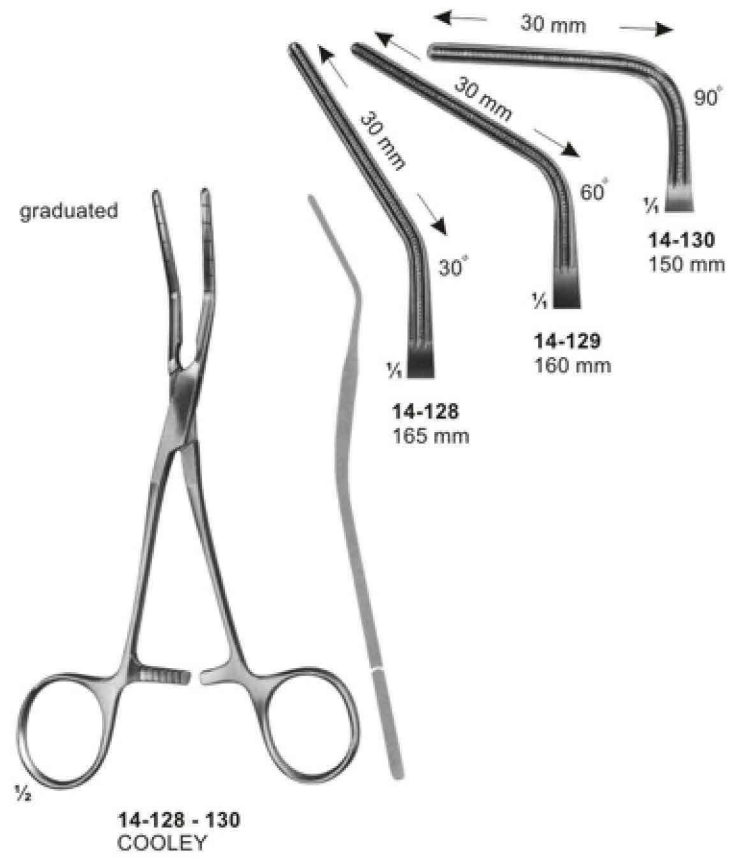
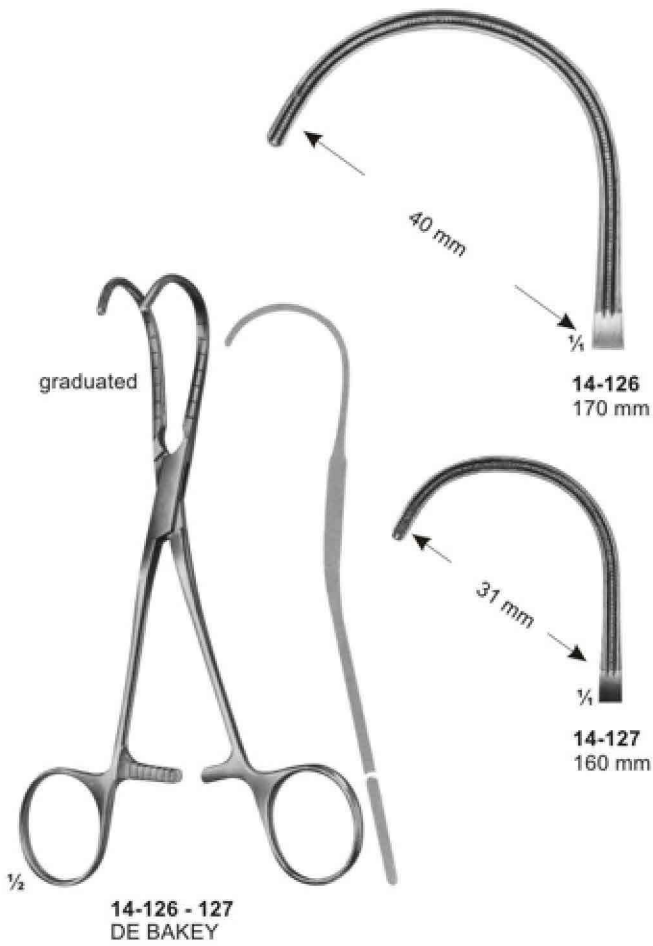

ATRAUMATA
Coarctation Clamps, Patent-Ductus & Peripheral-Vascular Clamps

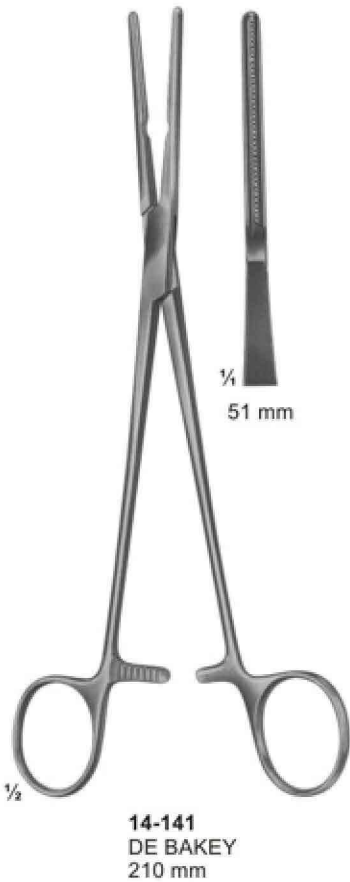
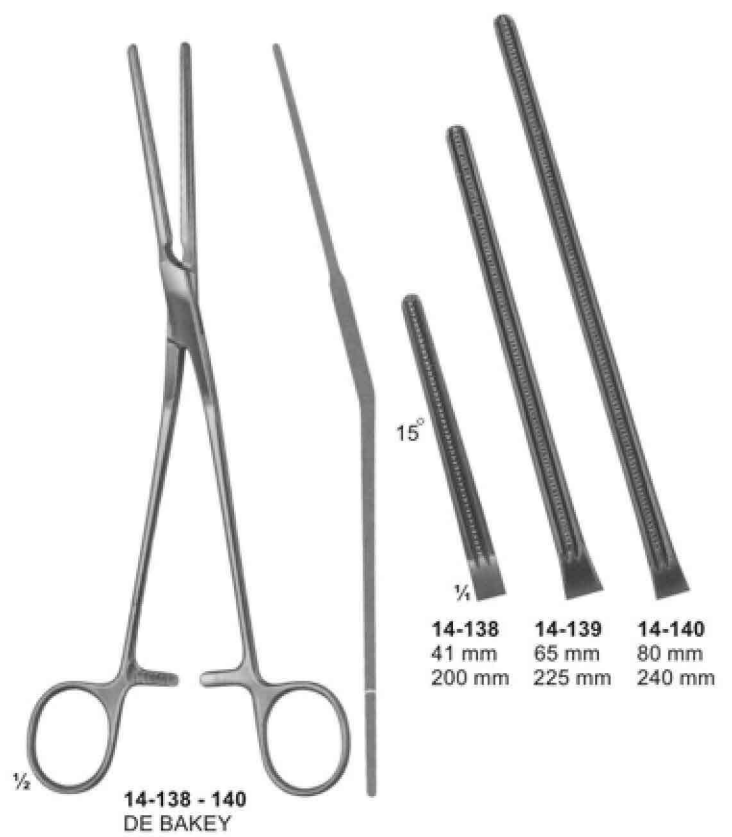
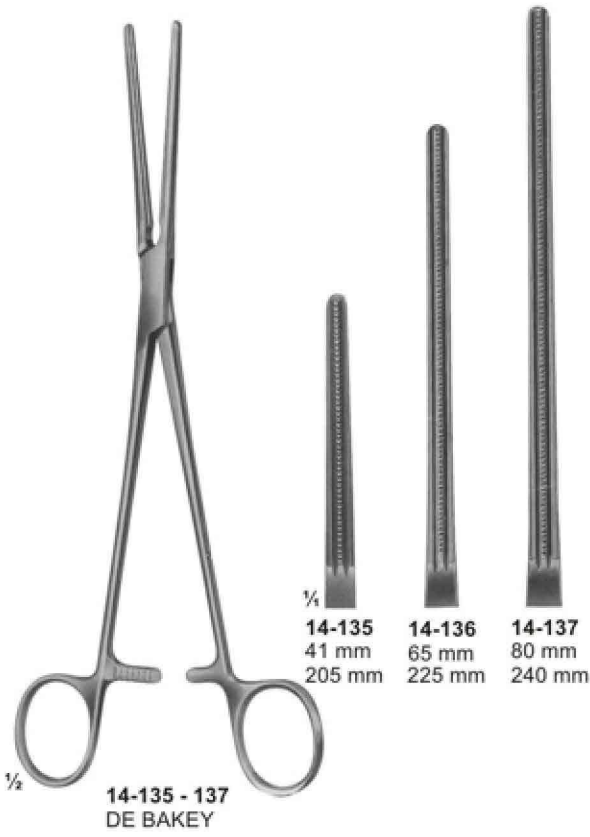

Aorta- Anastomosis Clamps



L
14-144
WEBER
260 mm

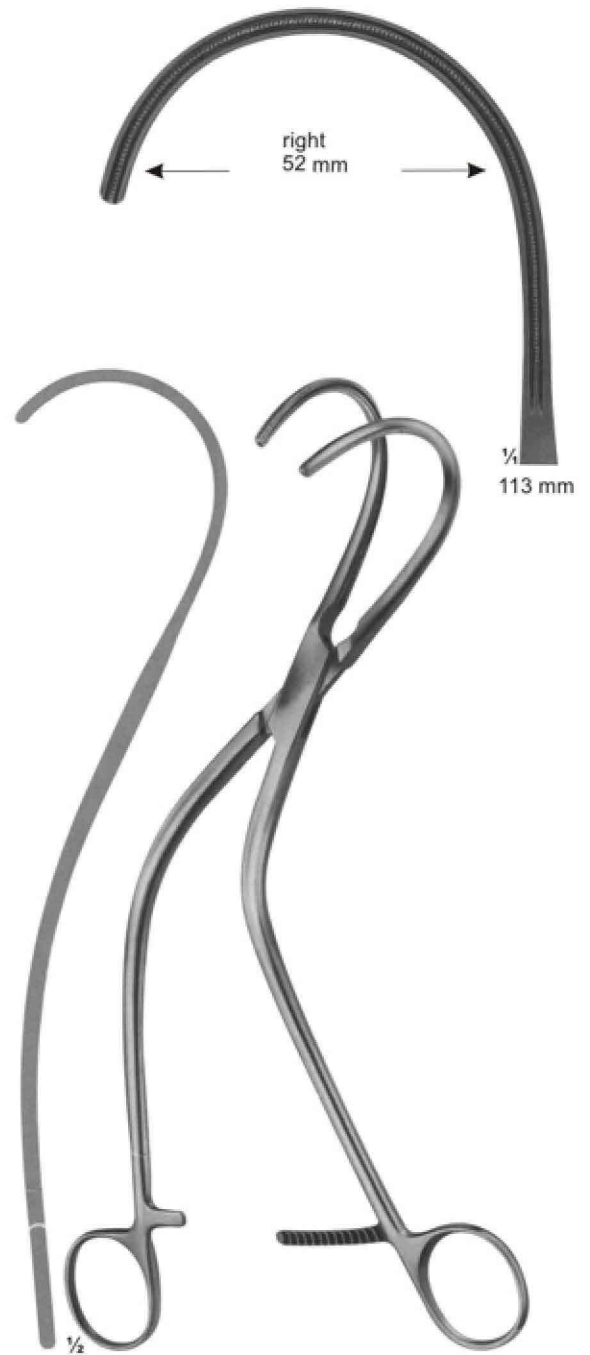

R
14-145
WEBER
260 mm

Multi- Purpose-Clamps

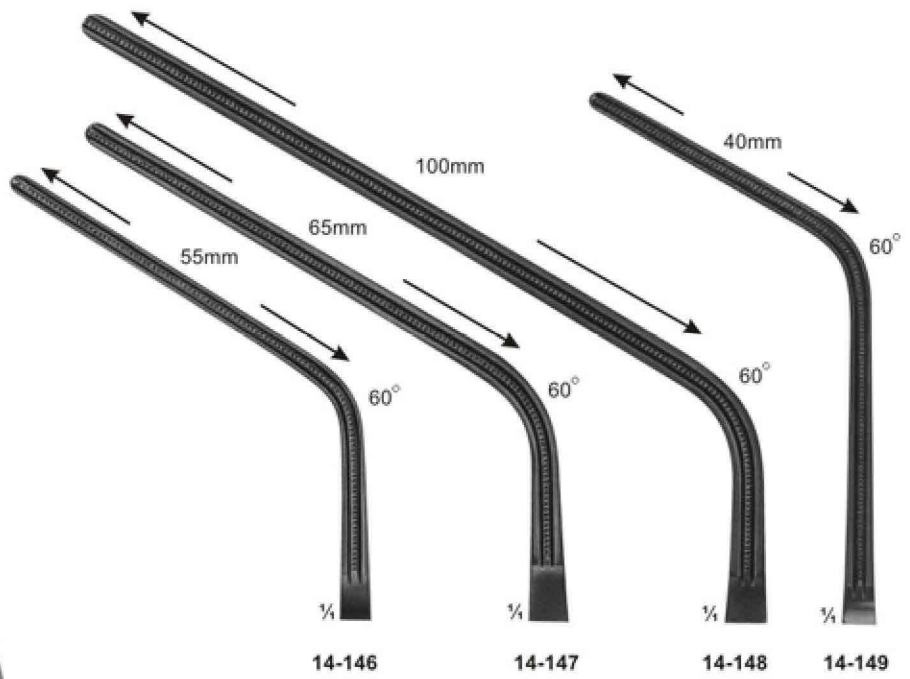

Total Length:	230 mm	280 mm	305 mm	240 mm
Length of jaws:	85 mm	100 mm	135 mm	93 mm

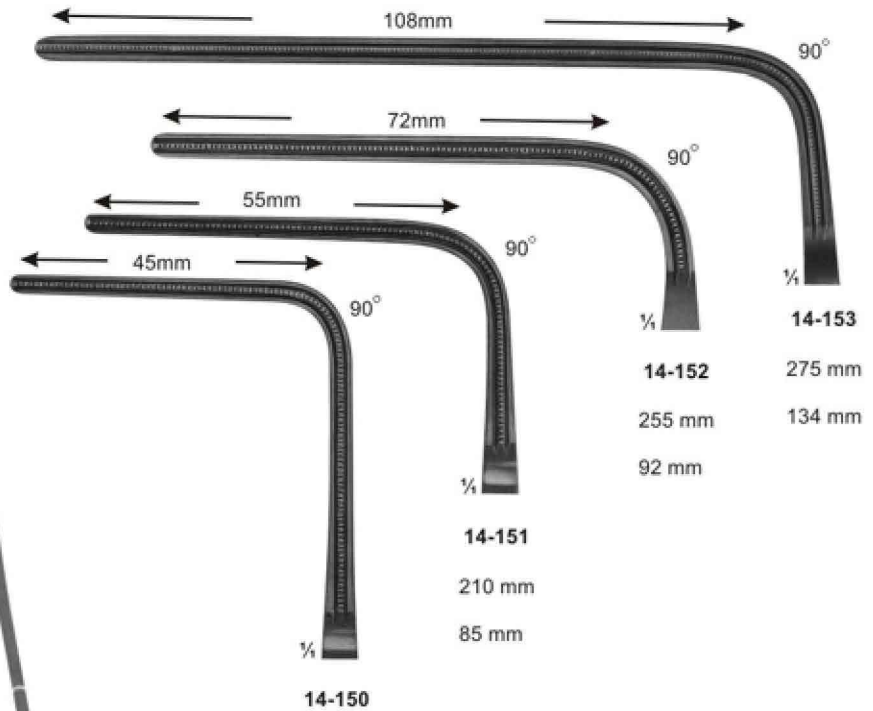

Total Length:	225 mm
Length of jaws:	93 mm

Sternum Instruments and Rib Shears



14-154
SCHUMACHER
Sternum shears
210 mm



14-155
LEBSCHKE
Sternum chisel
200 mm



14-156
230 mm



14-157
COLLIN
195 mm



14-158
GLUCK
190 mm



14-159
BETHUNE
340 mm



14-160
BRUNNER
Universal pattern
340 mm



14-161
GIERTZ-STILLE
250 mm

Rib Spreaders

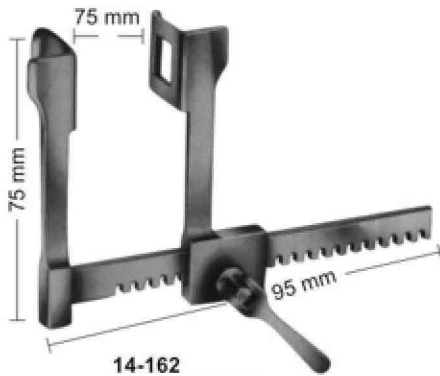

14-162
FINOCHIETTO
Blades
18X21 mm

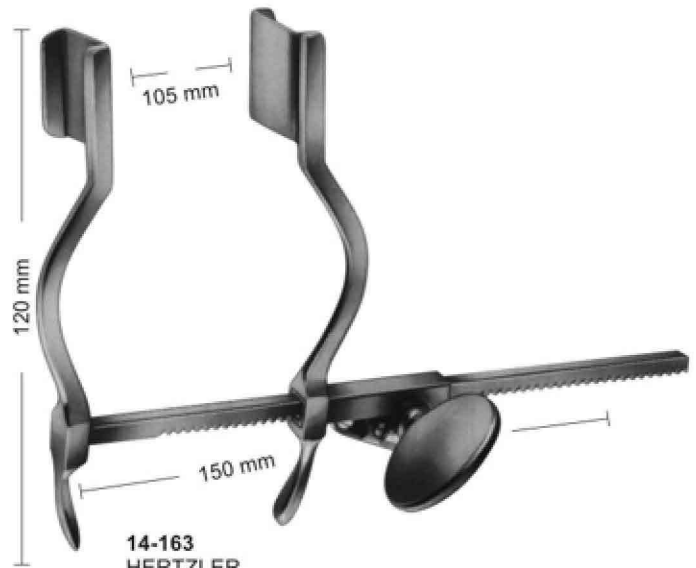

14-163
HERTZLER
Blades
20X25 mm

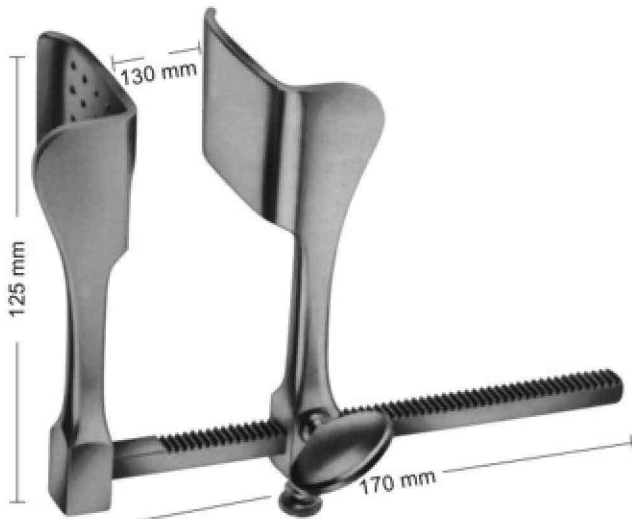

14-164
TUFFIER
Blades
43X53 mm

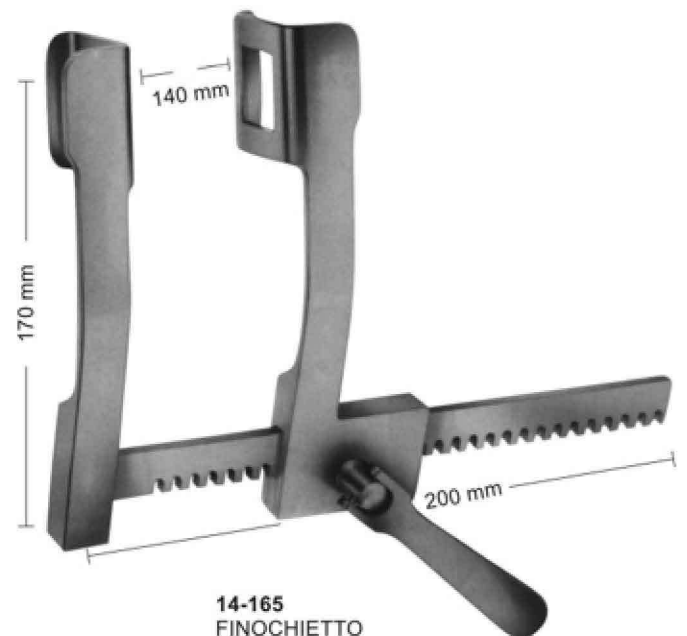

14-165
FINOCHIETTO
Blades
36X45 mm

Rib Spreaders-and Contractors



14-166
SELLORS
Rib spreader-and contractor
with swivel blades
200 mm



14-167
BAILEY
150 mm



14-168
for children

14-169
for adults

14-168 - 169
BAILEY
200 mm

Punches

130°

upwards cutting

15-101
1 mm



KERRISON - JACOBY

FERRIS-SMITH-KERRISON

15-102
2 mm



15-103
3 mm



15-104
4 mm



15-105
5 mm

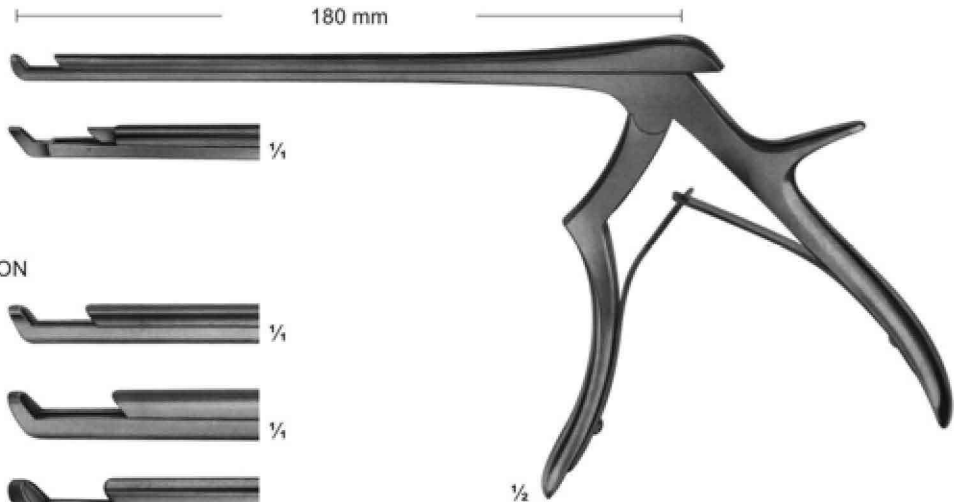

15-101 - 105

90°

upwards cutting

15-106
1 mm



15-107
2 mm



FERRIS-SMITH-KERRISON

15-108
3 mm



15-109
4 mm



15-110
5 mm

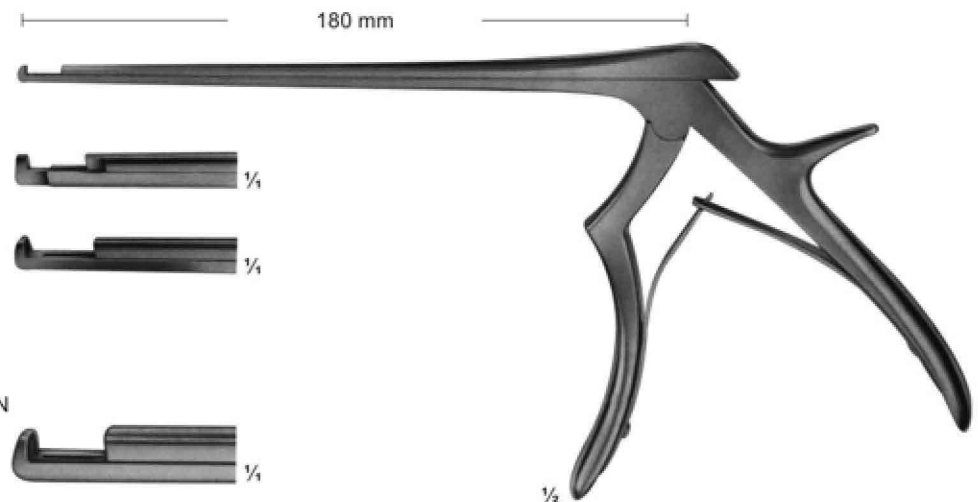

15-106 - 110

Punches

90° upwards cutting

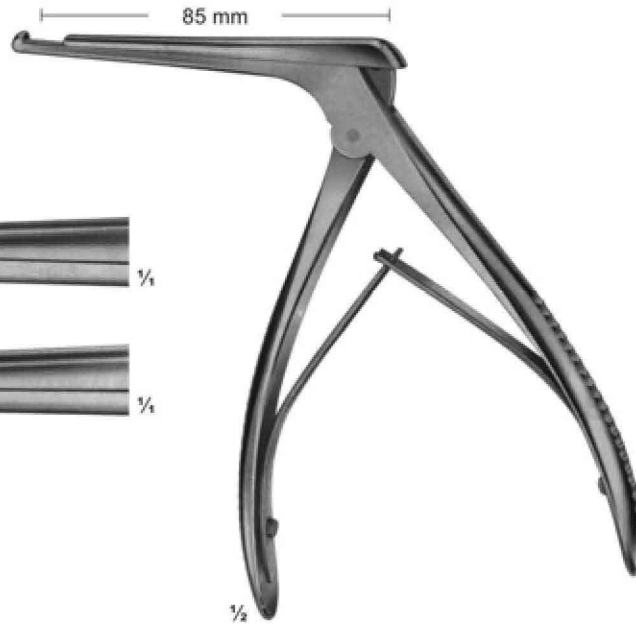

15-111
4 mm



15-112
5 mm



15-111 - 15-112
KERRISON

90° upwards cutting

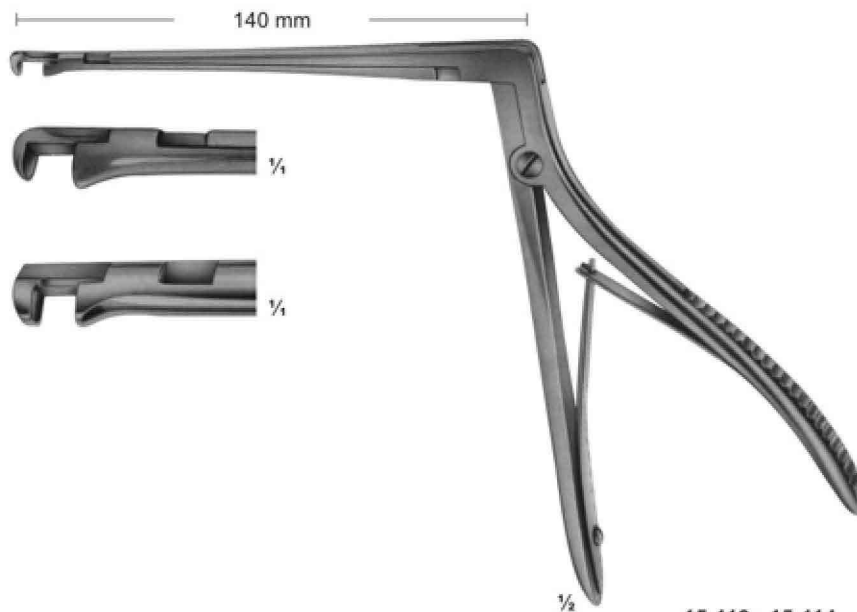

15-113
3,3 mm



15-114
4,0 mm



15-113 - 15-114
HAJEK-KOFLER

Rongeurs

LOVE-GRUENWALD

15-115
2 X 10 mm



15-116
3 X 10 mm



SPURLING

15-117
4 X 10 mm



15-115 - 15-117

15-118
2 mm



15-119
3 mm



15-120
4 mm



15-121
5 mm

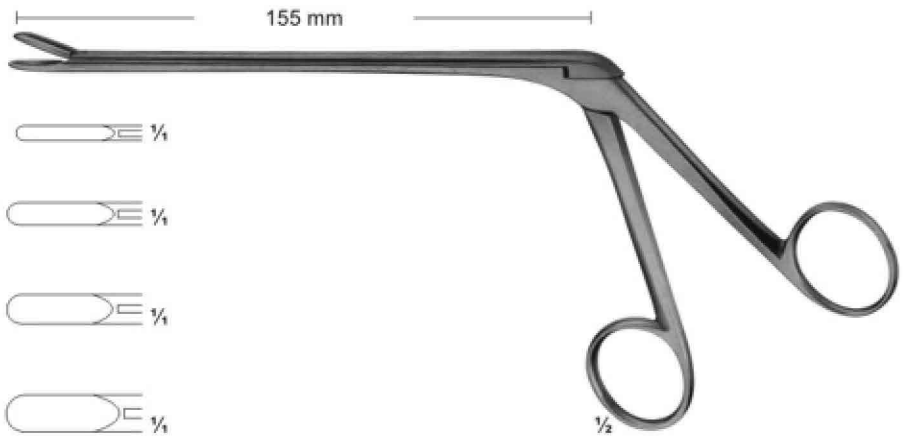

15-118 - 15-121
CASPAR

150°

15-122
2 mm



15-123
3 mm



15-124
4 mm

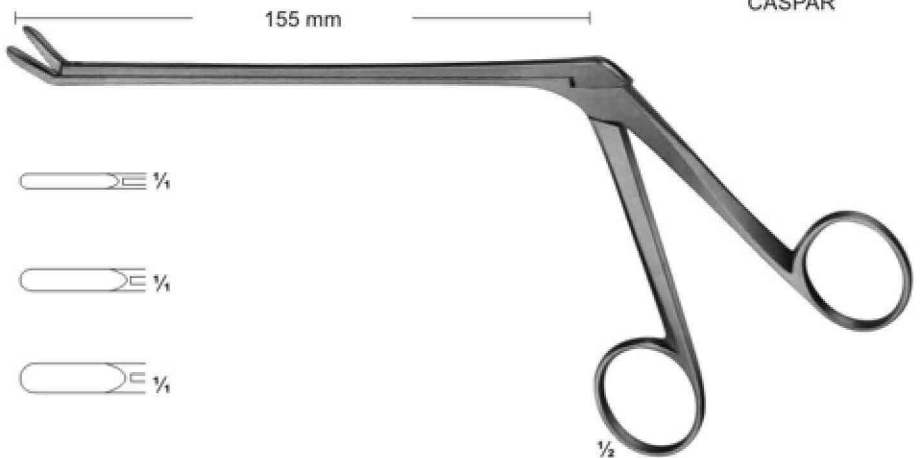

15-122 - 15-124
CASPAR

Rongeurs

Angled positions for rongeurs

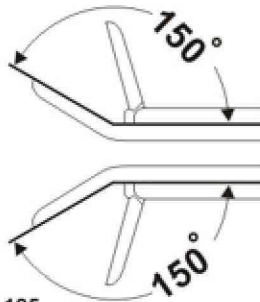

15-125
3,0 mm

15-126
3,6 mm

15-127
4,2 mm

15-128
4,8 mm

15-129
5,8 mm

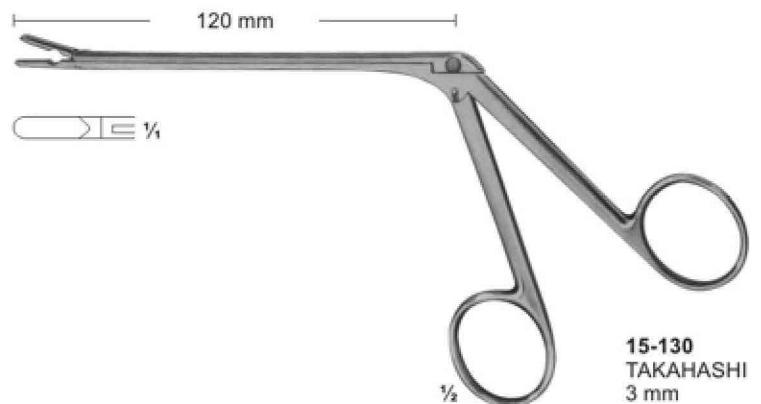
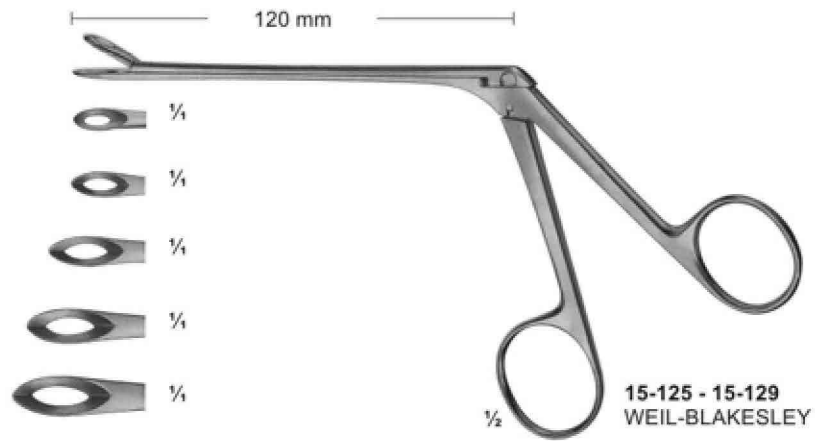
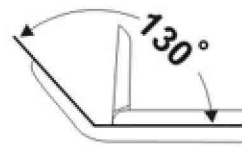
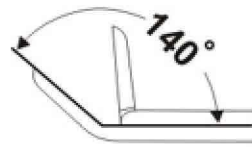

130°

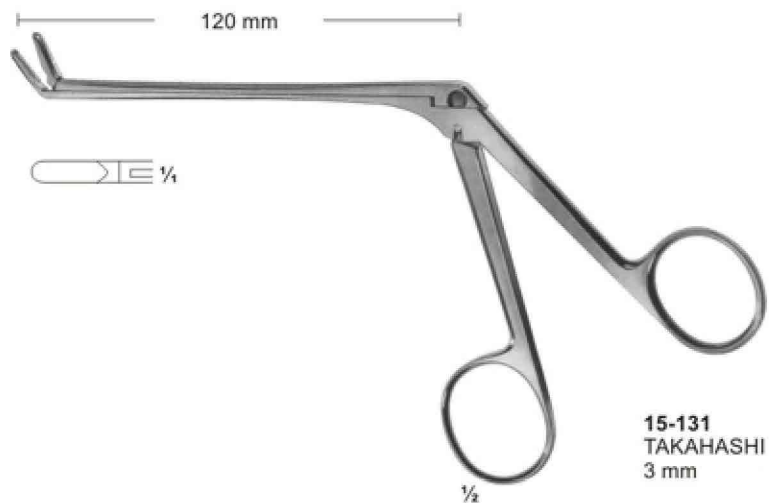

Rongeurs

150°

Lower part of jaws movable

15-132
2 mm

15-133
3 mm

15-134
4 mm

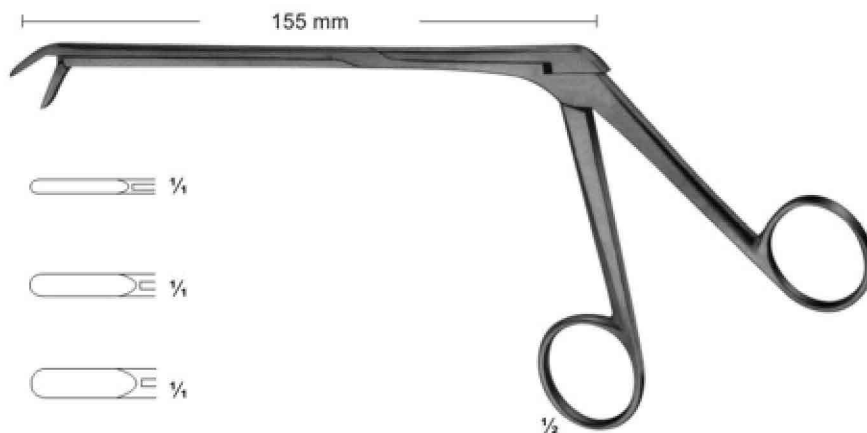

15-132 - 15-134
CASPAR

Length of shaft 140 mm	Length of shaft 160 mm	Length of shaft 185 mm	size of jaws
15-135	15-140	15-145	2 X12 mm
15-136	15-141	15-146	3 X12 mm
15-137	15-142	15-147	4 X14 mm
15-138	15-143	15-148	5 X14 mm
15-139	15-144	15-149	6 X16 mm

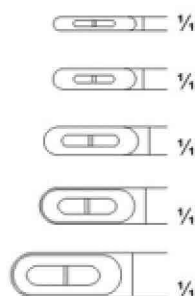

15-135 - 15-149
CASPAR

150°

Length of shaft 140 mm	Length of shaft 160 mm	Length of shaft 185 mm	size of jaws
15-150	15-153	15-156	3 X12 mm
15-151	15-154	15-157	4 X14 mm
15-152	15-155	15-158	5 X14 mm

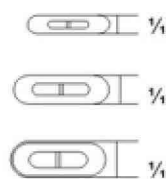

15-150 - 15-158
CASPAR

Rongeurs

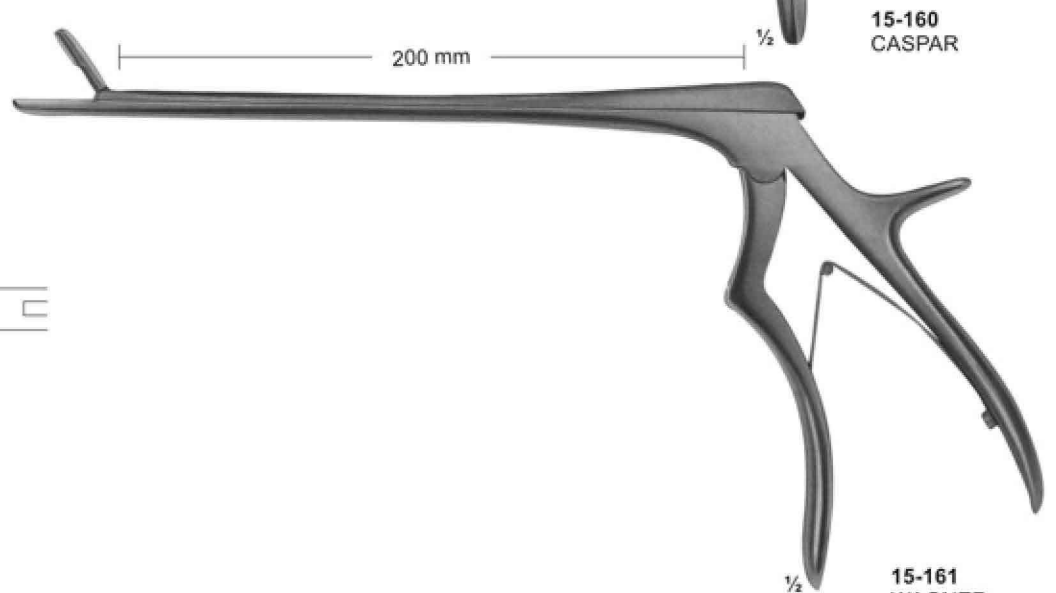
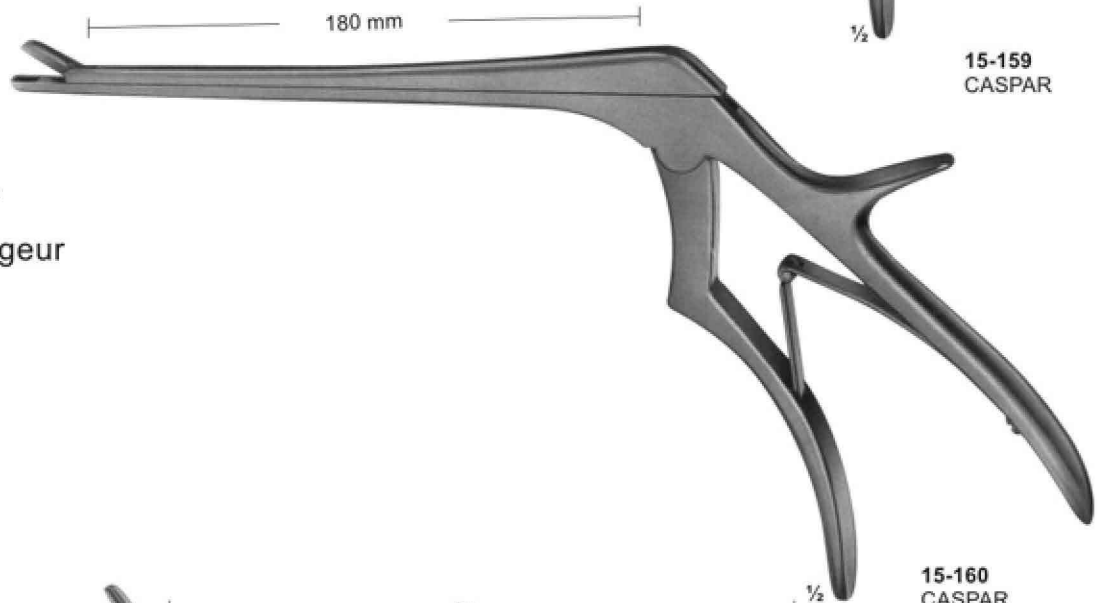
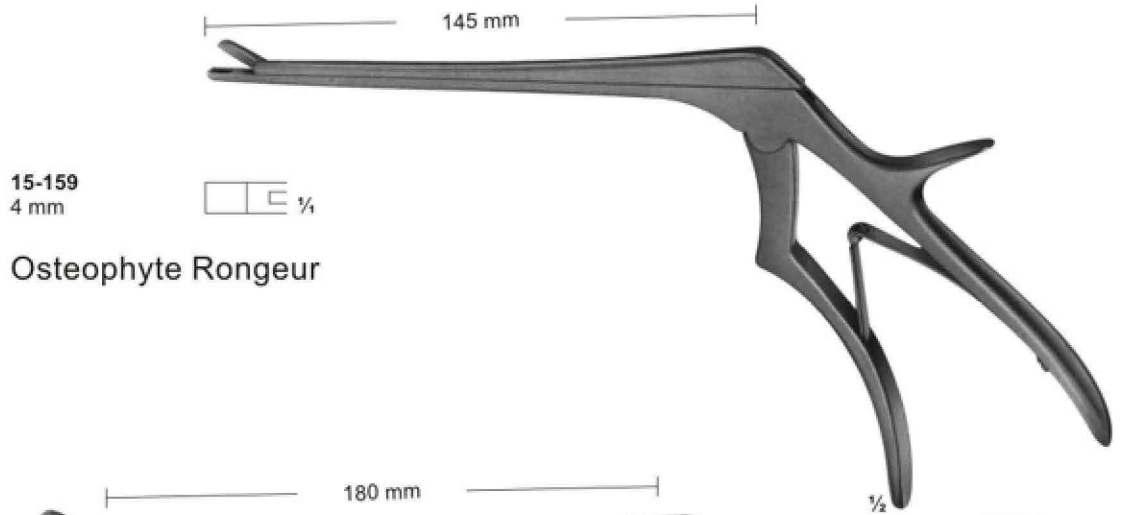

15-159
CASPAR

15-160
CASPAR

15-161
WAGNER

Elevators and Bone Levers

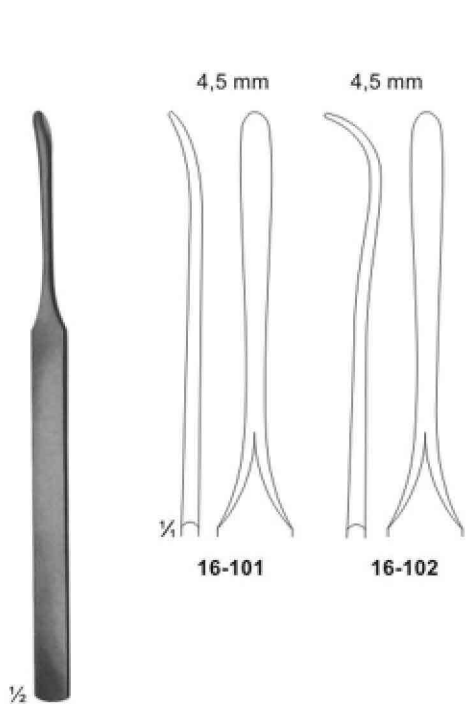

16-101 - 102
KONIG
155 mm

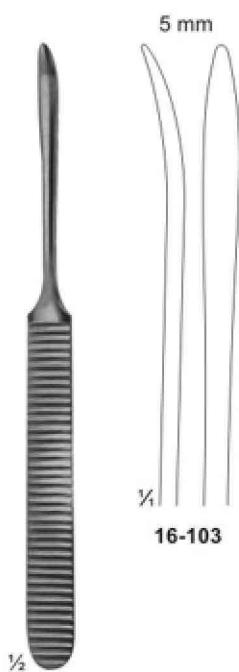

16-103
WILLIGER
165 mm

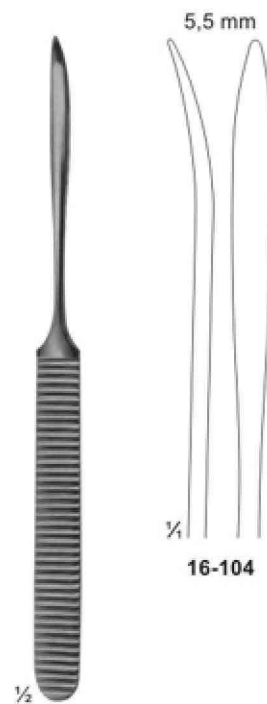

16-104
WILLIGER
170 mm

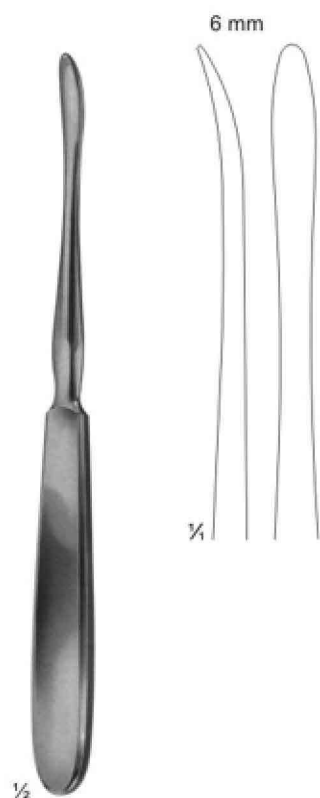

16-105
QUERVAIN
195 mm

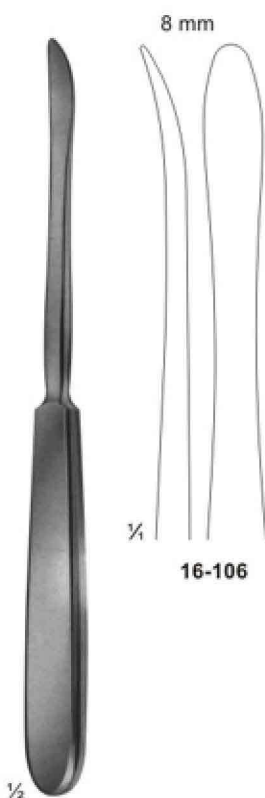

16-106 - 107
LANGENBACK
195 mm

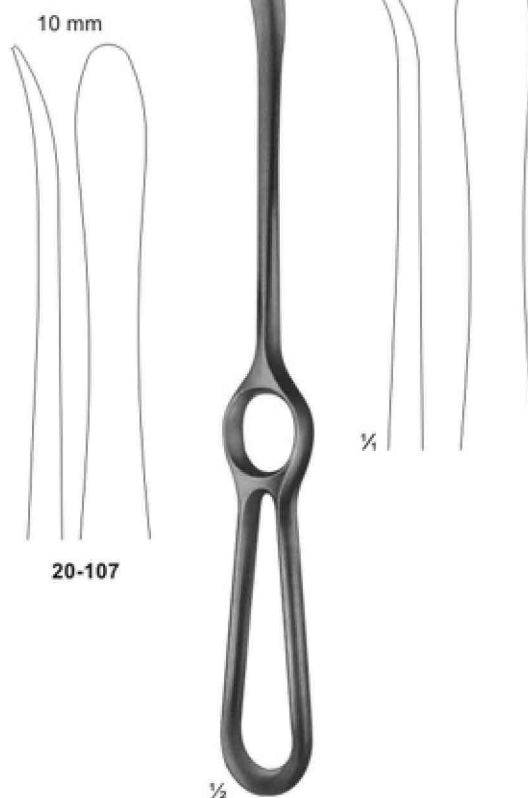

16-108
LANGENBACK
230mm

Bone Levers

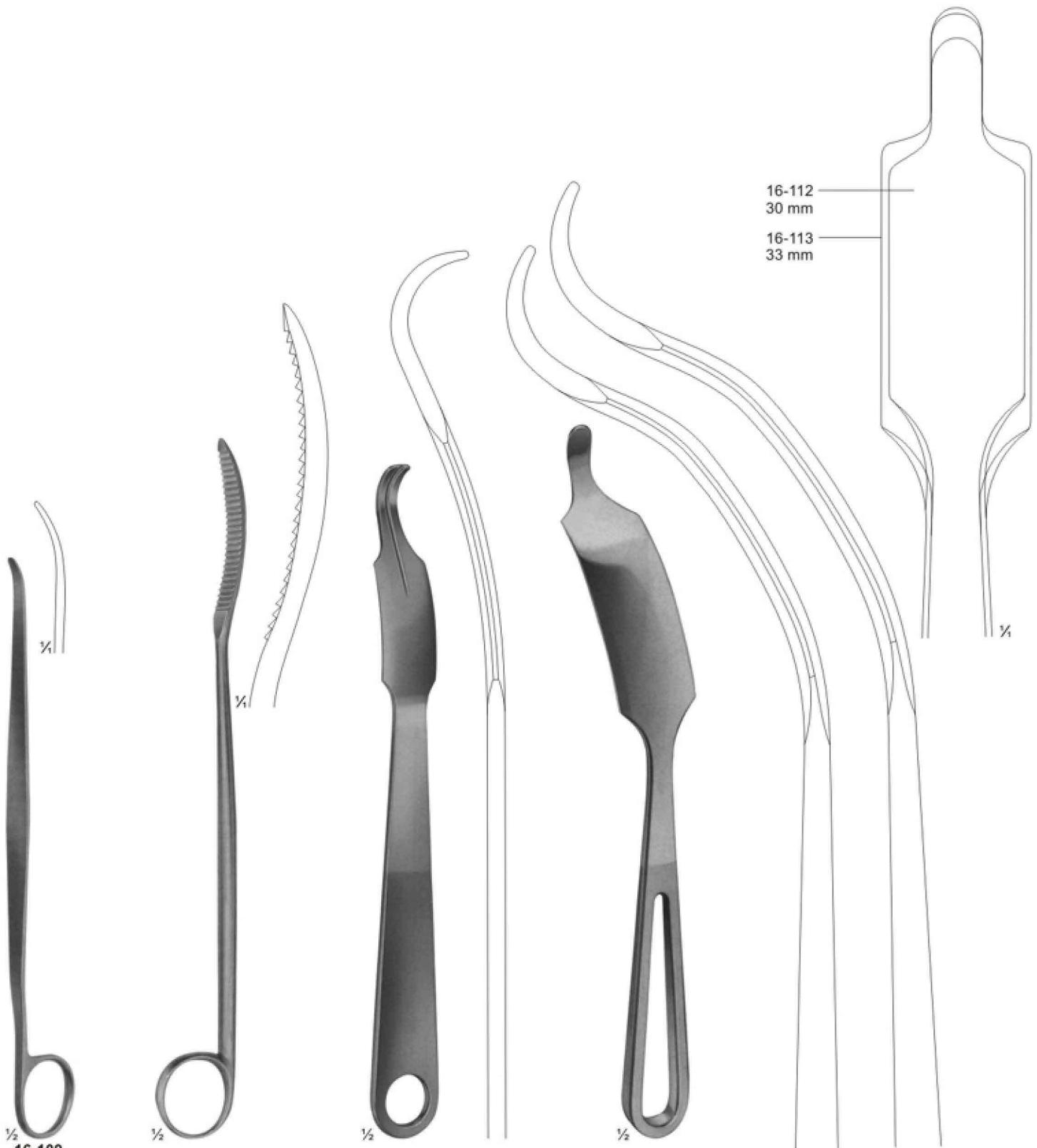

16-109
LANE TRETHOWAN
215mm

16-110
LANE
255mm

16-111
LANE-HOHMANN
250mm

16-112 - 113
LANE-HOHMANN modif.
16-112 265mm
16-113 280mm

Raspatories



16-114
PARTSCH
150 mm



16-116
PARTSCH mod. LANGE
145 mm



16-117
MC KENTY
155 mm

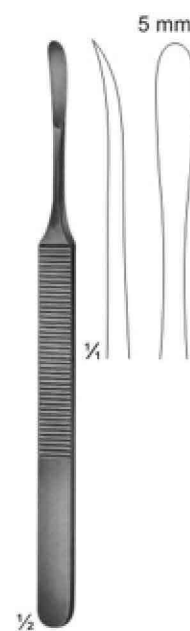

16-118
KOENIG
155 mm

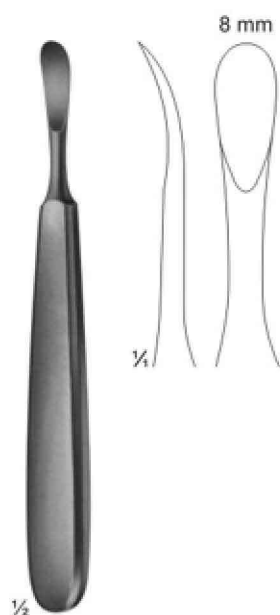

16-119
TRELAT
150 mm

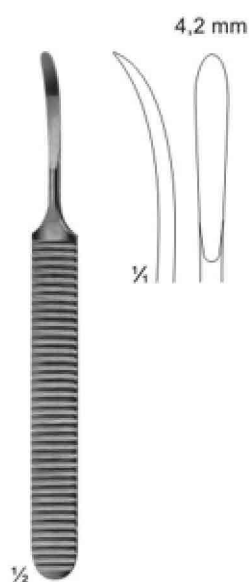

16-120
WILLIGER
140 mm

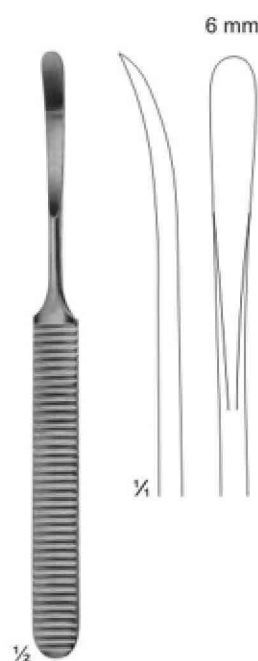

16-121
WILLIGER
160 mm

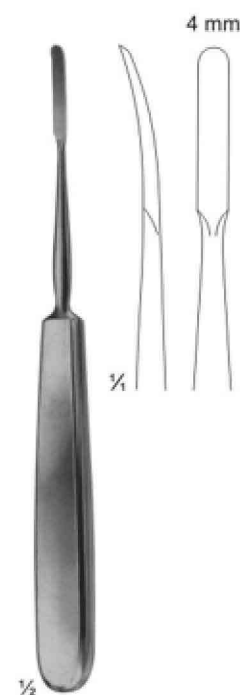

16-122
JOSEPH
170 mm

Bone File and Rasps

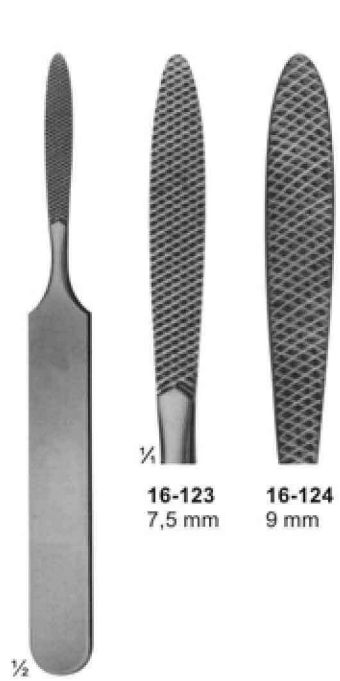

1/4
16-123
 7,5 mm
16-124
 9 mm

1/2
16-123
JOSEPH
 fine, chequered

16-124
 coarse, chequered
 165 mm

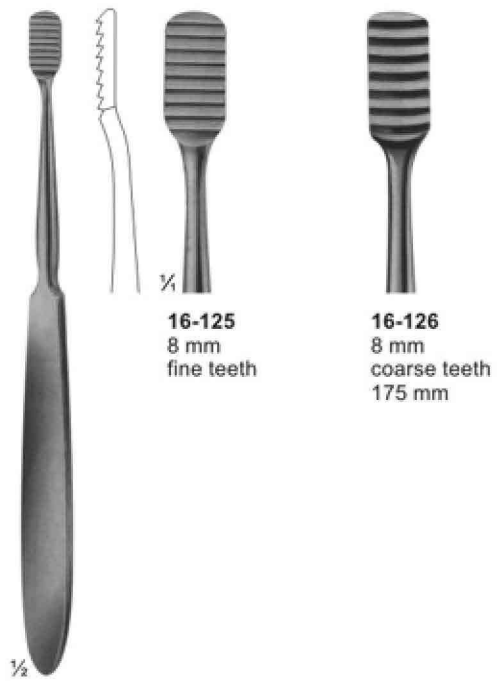

1/4
16-125
 8 mm
 fine teeth

16-126
 8 mm
 coarse teeth
 175 mm

1/2
16-125 - 16-126
LEWIS



1/2
16-127
MALTZ
 down stroke
 180 mm

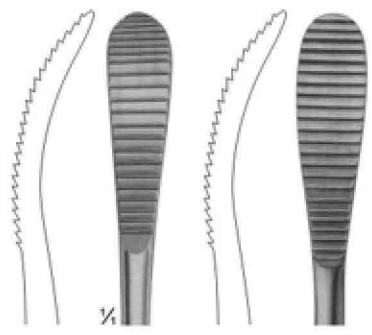

1/4
16-128
 9 mm

16-129
 9 mm



1/2
16-128 - 16-129
AUFRICHT
 up stroke
16-129
 down stroke
 220 mm



1/2
16-130
GALLAHER
 190 mm

Bone Currettes



16-131
JACOBSON
140 mm



16-132
MARTINI
140 mm



16-133
MARTINI
140 mm



16-134
WILLIGER
145 mm



16-135
JANSEN
160 mm



16-136
BARTH
180 mm

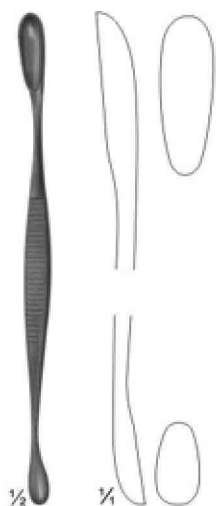

16-137
VOLKMANN
130 mm

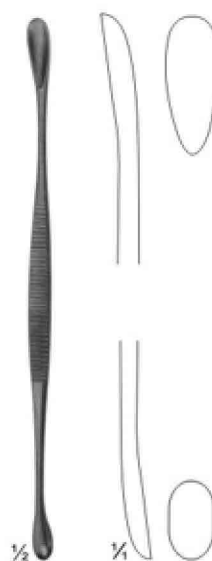

16-138
VOLKMANN
145 mm

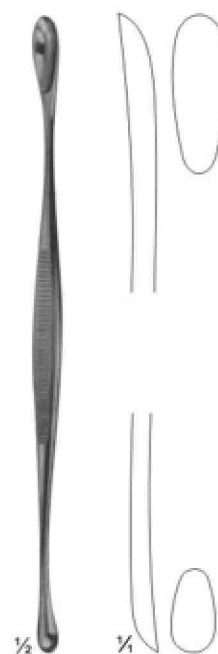

16-139
VOLKMANN
170 mm

Mallets Weights refer to the heads of the mallets
Hammer Die Gewichtsangaben beziehen sich auf den Kopf des jeweiligen Hammers



17-101
 MEAD
 185 g
 with interchangeable
 plastic disks
 190 mm
17-102
 pair of spare disks



17-103
 140 g
 with interchangeable
 plastic disks
 185 mm
17-104
 pair of spare disks



17-105
 COTTLE
 140 g
 1 Side Flat
 1 Side convex
 185 mm



17-106
 165 g
 lead filled head
 190 mm

Osteotomes, Chisels and Gouges



17-107
MANNERFELT
Gouge
155 mm

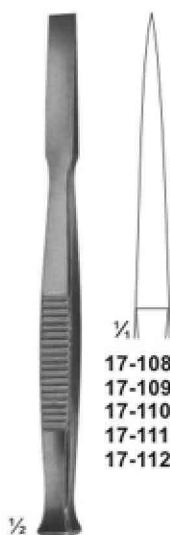

17-108 - 112
Osteotomes
140 mm

17-108 4 mm
17-109 6 mm
17-110 8 mm
17-111 10 mm
17-112 12 mm

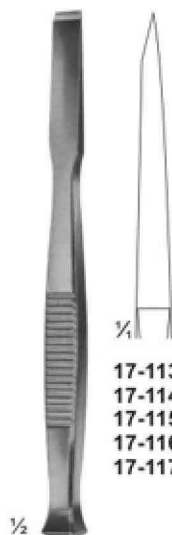

17-113 - 117
Chisels
140 mm

17-113 4 mm
17-114 6 mm
17-115 8 mm
17-116 10 mm
17-117 12 mm

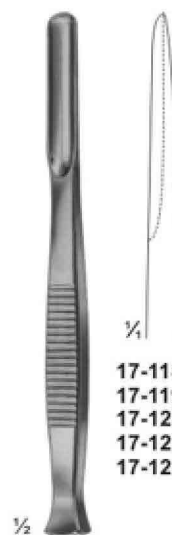

17-118 - 122
Gouges
140 mm

17-118 4 mm
17-119 6 mm
17-120 8 mm
17-121 10 mm
17-122 12 mm

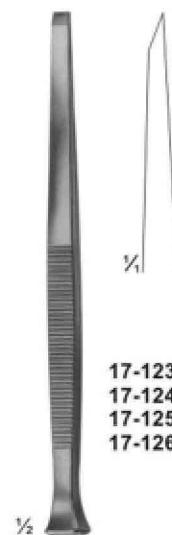

PARTSCH
17-123 - 126
Chisels
140 mm

17-123 3 mm
17-124 4 mm
17-125 5 mm
17-126 6 mm

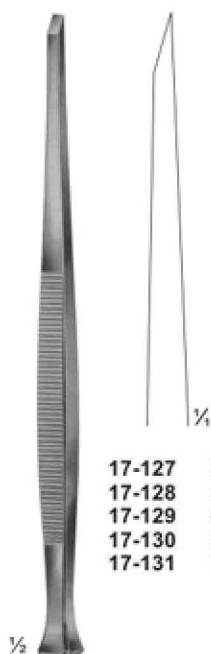

PARTSCH
17-127 - 131
Chisels
170 mm

17-127 3 mm
17-128 4 mm
17-129 5 mm
17-130 6 mm
17-131 7 mm



PARTSCH
17-132 - 135
Gouges
140 mm

17-132 3 mm
17-133 4 mm
17-134 5 mm
17-135 6 mm



PARTSCH
17-136 - 140
Gouges
170 mm

17-136 3 mm
17-137 4 mm
17-138 5 mm
17-139 6 mm
17-140 7 mm



LUCAS
17-141 - 142
Chisels
160 mm

17-141 4 mm
17-142 6 mm



LUCAS
17-143 - 144
Gouges
160 mm

17-143 3 mm
17-144 5 mm

Reposition Forceps, Bone Holding Forceps



17-145
Patella forceps
185 mm



17-146
Forceps with
ratchet fixation
140 mm



17-147
Forceps with
thread fixation
170 mm



17-148
Forceps with
thread fixation
235 mm

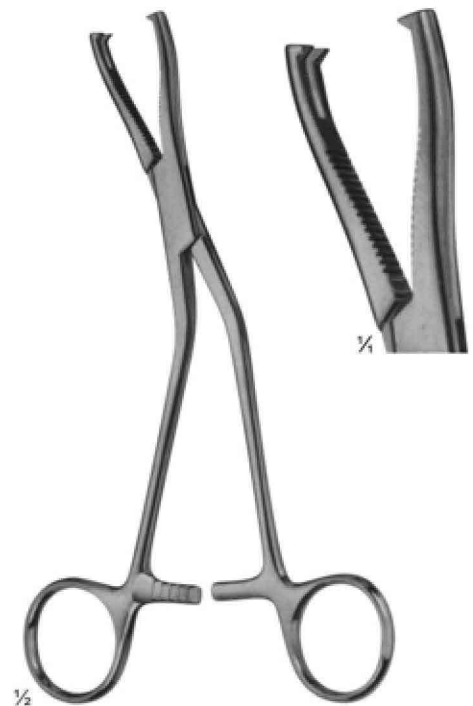

17-149
DINGMANN
185 mm

Bone Holding Forceps & Bone Clamps

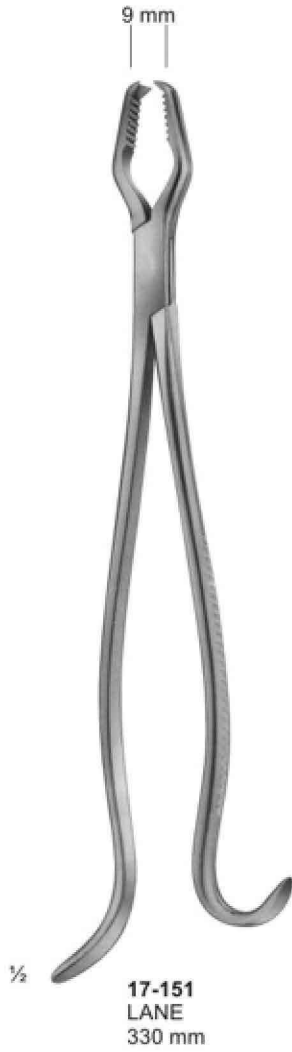

Bone Rongeurs



17-158
LUER
150 mm

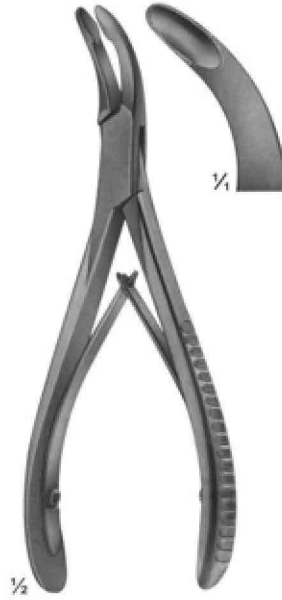

17-159
LUER
155 mm

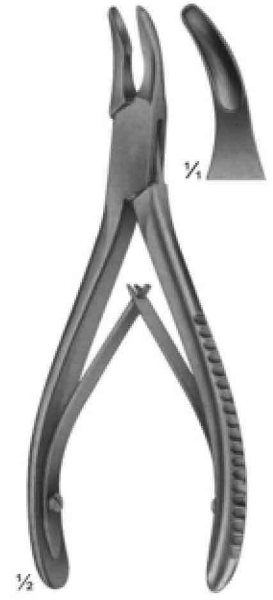

17-160
BLUMENTHAL
155 mm

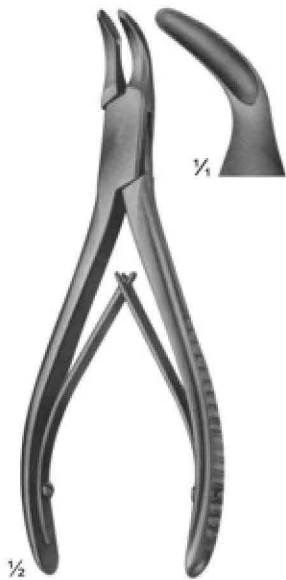

17-161
BLUMENTHAL
150 mm



17-162 - 163
JANSEN
175 mm

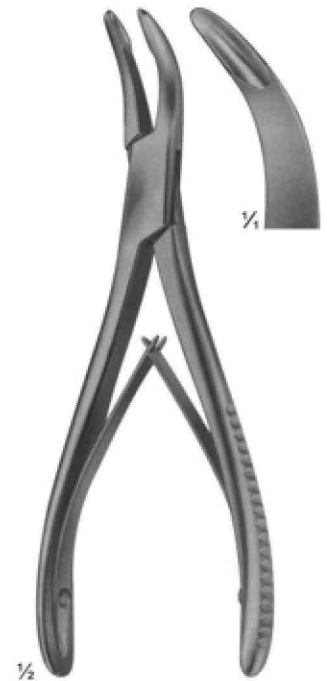

17-164
BANE-HARTMANN
175 mm

Bone Rongeurs



17-165
STILLE
235 mm



17-166
LEKSELL-STILLE
240mm



17-167
STILLE-RUSKIN
240mm

Bone Cutting Forceps

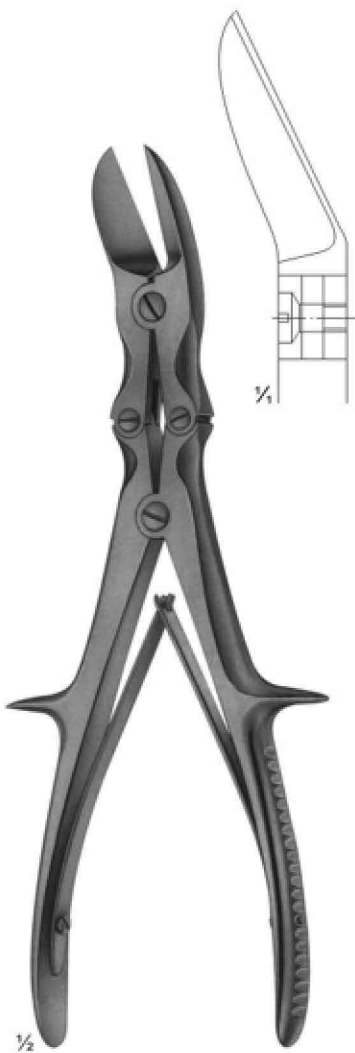

17-168
LISTON
curved on flat
240 mm

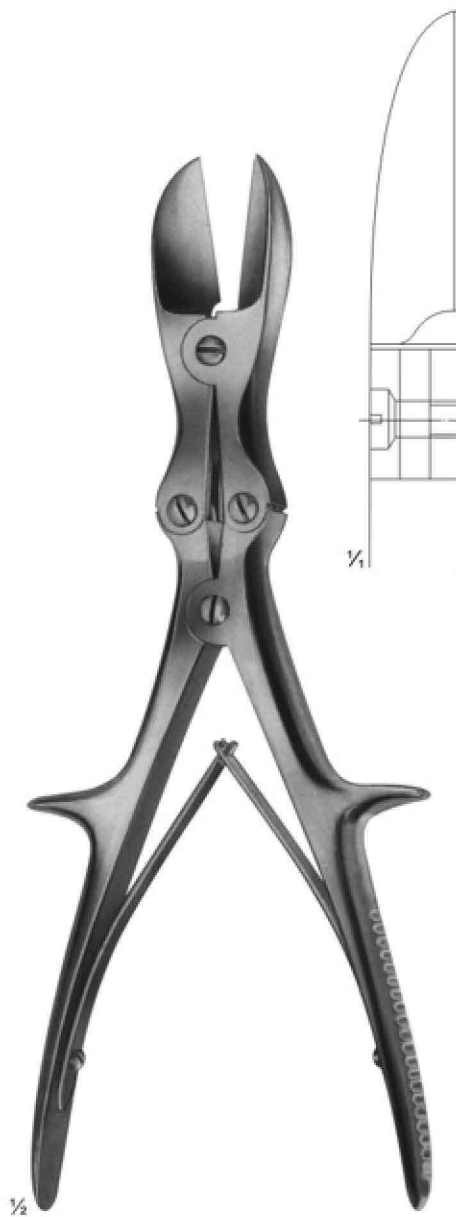

17-169
LISTON
straight
280 mm

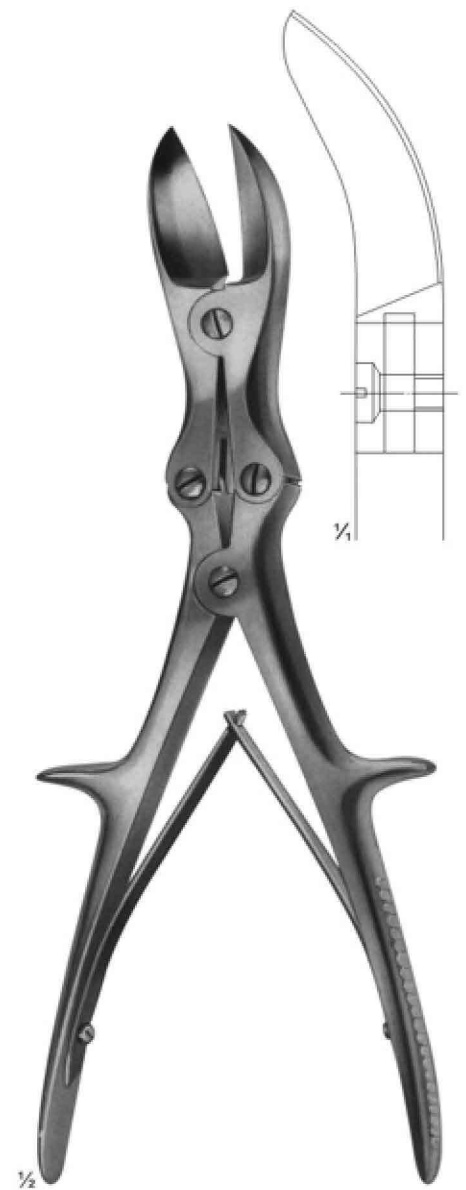

17-170
LISTON
curved on flat
280 mm

Wire Extension

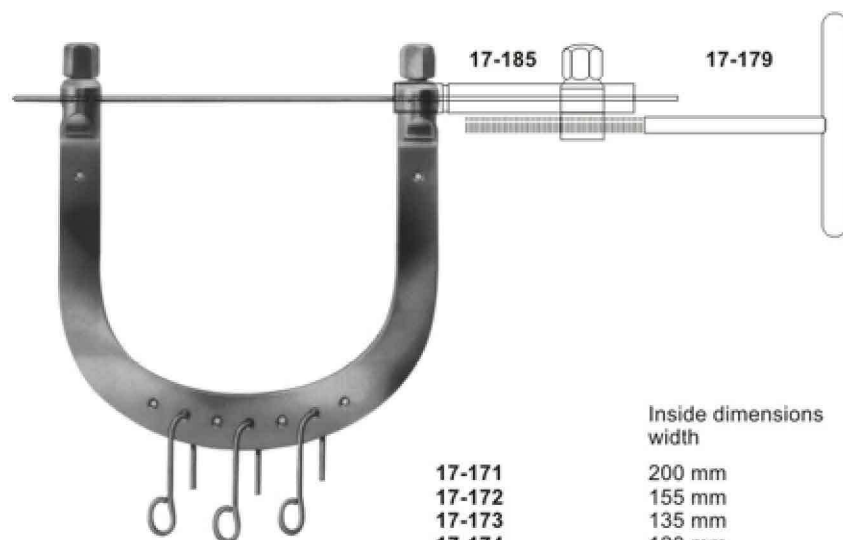

17-171 - 17-177
KIRSCHNER
Wire traction bows,
to be used with
KIRSCHNER-wires
up to 2.5 mm diam.,
With 3 hooks,
stainless steel

	Inside dimensions width	depth	
17-171	200 mm	155 mm	for the hip
17-172	155 mm	155 mm	for the femur
17-173	135 mm	130 mm	for the knee
17-174	120 mm	120 mm	for the knee
17-175	105 mm	100 mm	for the knee
17-176	95 mm	110 mm	for the calcaneus
17-177	95 mm	70 mm	for the arm and elbow



17-178
Wrench, double - ended,
for wire traction bows

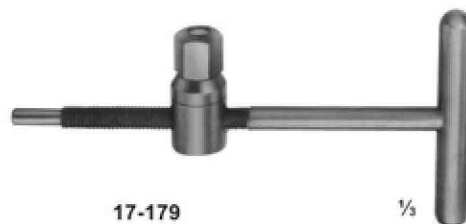

17-179
Wire tightener, with
clamping jaws



17-182	max. 105 mm
17-183	max. 160 mm
17-184	max. 200 mm
17-182	80-95 mm
17-183	90-120 mm
17-184	140-170 mm
diam upto	
17-182	1,6 mm
17-183	2,0 mm
17-184	2,5 mm

17-182 - 17-184
KIRSCHNER
Wire traction bows, modified,
adjustable in width, holds wire
securely, with 1 hook



17-180
Traction hook only,
large size



17-181
Traction hook only,
small size



17-185
Fixation clamp, to secure clamping
jaws of 17-179 stainless steel

Cerclage Instruments

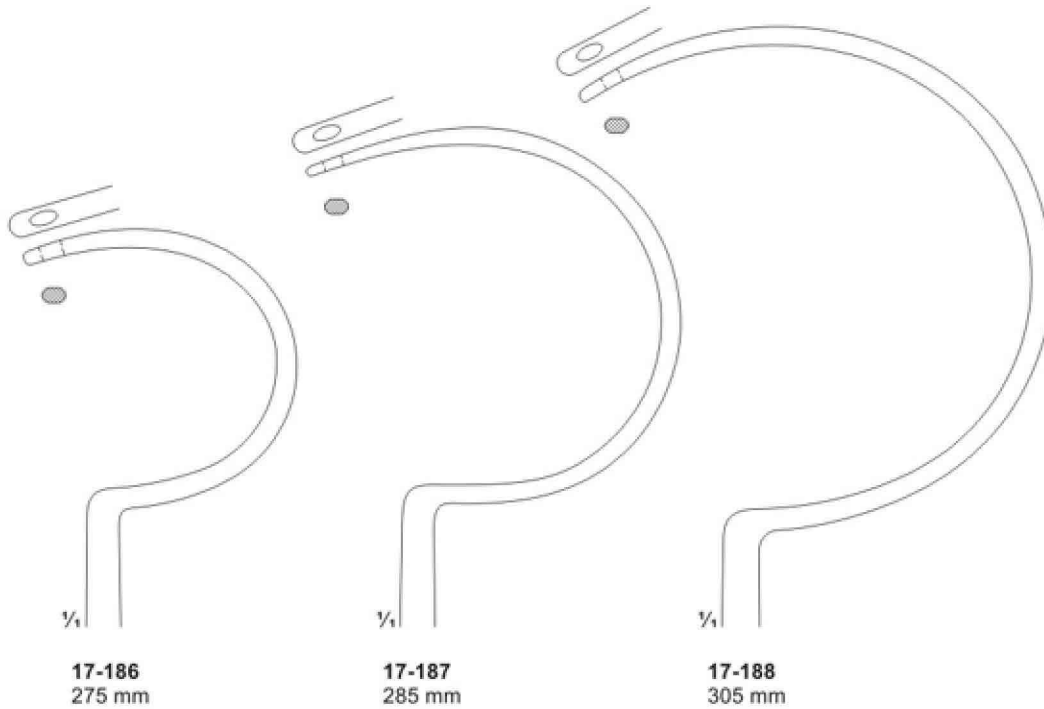

17-186 - 17-188
DEMEL
Wire guides

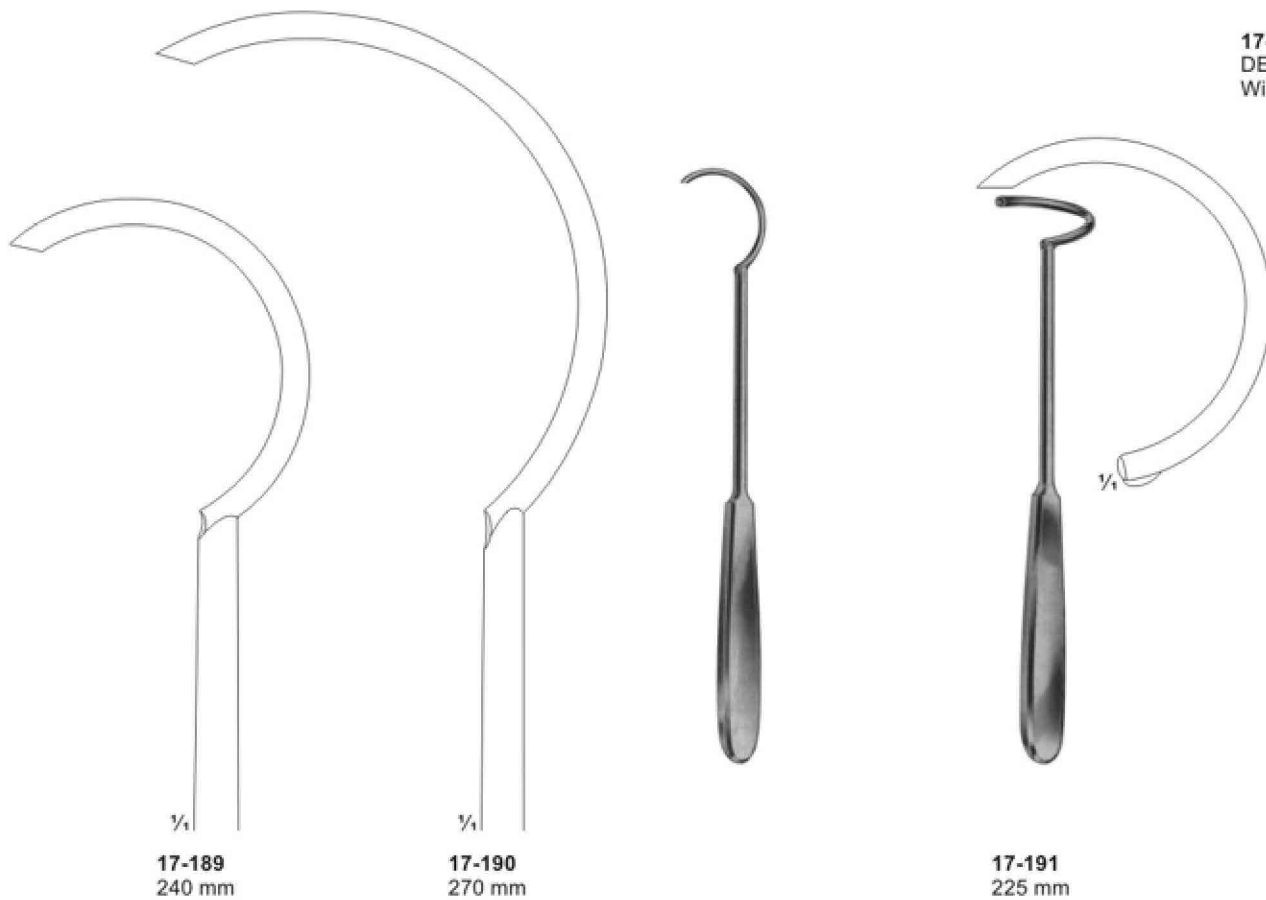

Wire Holding forceps, Wire Tightening Pliers, Flat-nosed Pliers DUROGRIP with Hard Metal Inserts



17-192
DUROGRIP
Holding forceps for cerclage wire, with lateral jaws to avoid wire slipping off
170 mm



17-193
DUROGRIP
Wire, tightening pliers, Ligature pliers
150 mm



17-194
DUROGRIP
Wire, tightening pliers, Ligature pliers
150 mm



17-195
with serrated jaws
140 mm



17-196
one jaw smooth, one jaw serrated
140 mm



17-197
with serrated jaws
17-198
with longitudinal and transversal grooves
170 mm



17-199
190 mm

Wire Holding forceps, Flat-nosed Pliers, Pliers for bending and cutting wires

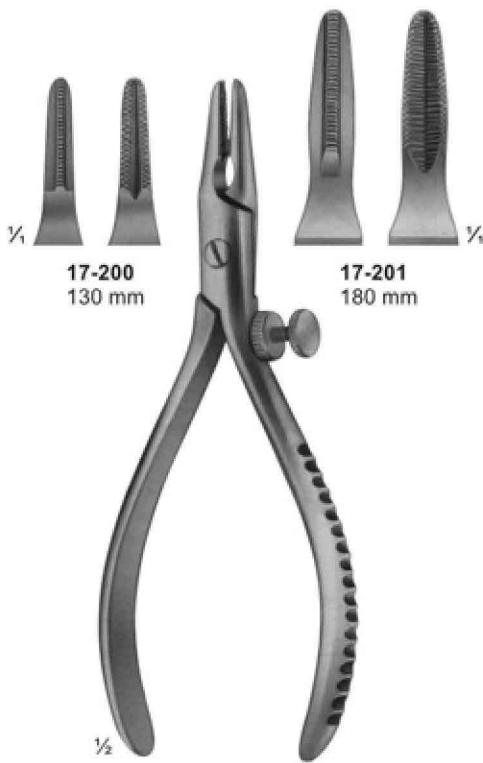

17-200 - 17-201
Extraction pliers
for boring wires

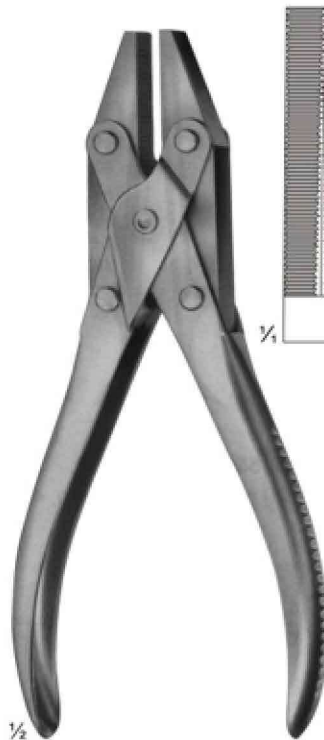

17-202
Flat-nosed pliers,
parallel
185 mm

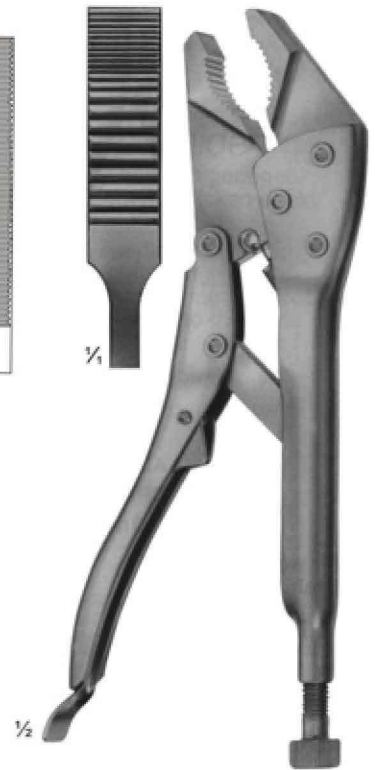

17-203
Vise grip
200 mm



17-204
Round Pliers
180mm

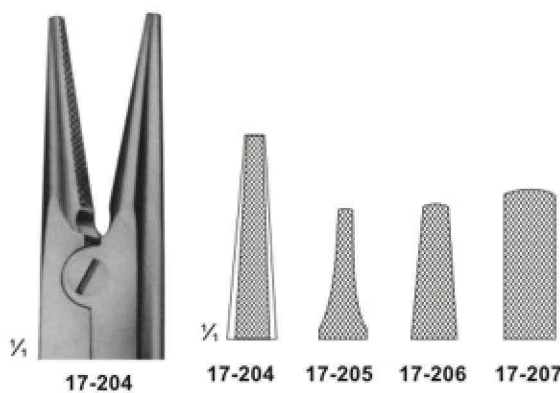

17-205 145 mm
17-206 180 mm
17-207 180 mm
Extraction pliers for wires



17-208
Bending pliers
for wires up to
1.8 mm diam.

Wire Cutters and wire Cutting Scissors DUROTIP with Carbide Cutting Edges



17-209
ANGLE
130 mm

for soft wire
up to diam.
for hard wire
up to diam.

0,5 mm
0,3 mm

17-210
DUROTIP
ANGLE
130 mm

0,6 mm
0,4 mm

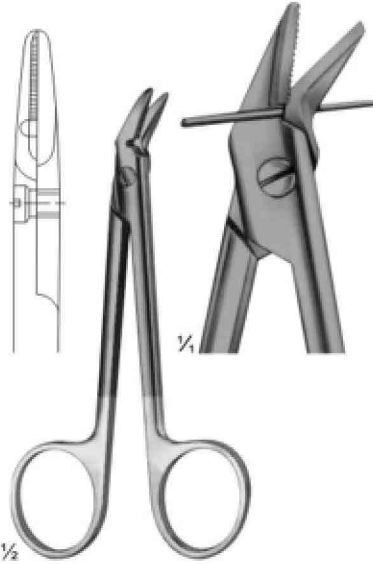

17-211
120 mm

for soft wire
up to diam.
for hard wire
up to diam.

1,2 mm
0,8 mm

17-212
DUROTIP
120 mm

1,2 mm
0,8 mm

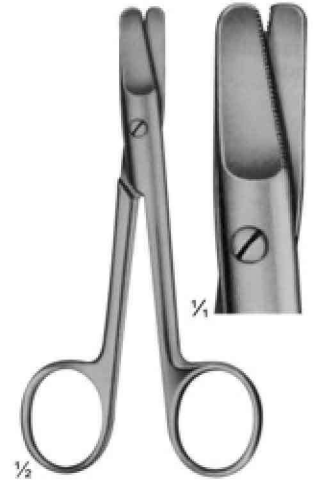

17-213
HARVEY
125 mm

0,4 mm
0,3 mm



17-214
150 mm

for soft wire
up to diam
for hard wire
up to diam

1,5 mm
1,0 mm



17-215
160 mm

1,5 mm
1,2 mm



17-216
140 mm
DUROTIP
1,5 mm

1,0 mm

Wire Cutting Pliers, Lateral Cutting Action



17-217
180 mm

for soft wire
up to diam. 2,0 mm
For hard wire 1,5 mm
up to diam
specially hardened
cutting edges, front
and lateral cutting
action



17-218
REILL
175 mm

for soft wire
up to diam. 2,0 mm
For hard wire 1,6 mm
up to diam
specially hardened
cutting edges, for
cutting off wires close
to the bone



DUROTIP

17-219
235 mm

for soft wire
up to diam. 3,0 mm
For hard wire 2,2 mm
up to diam

Wire Cutting Pliers, Lateral and Front Cutting Action



17-220
240 mm

for soft wire
up to diam. 2,0 mm
For hard wire
up to diam 1,6 mm



17-221
145 mm

for soft wire
up to diam. 1,5 mm
For hard wire
up to diam 1,0 mm

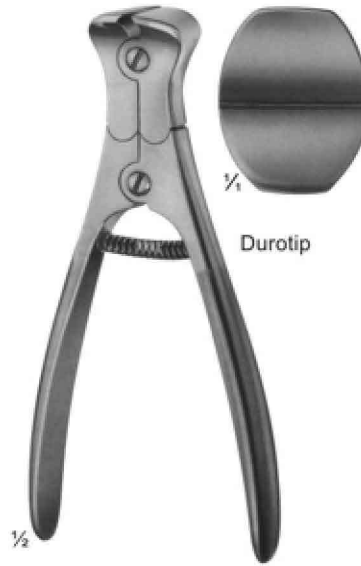

17-222
145 mm

for soft wire
up to diam. 2,0 mm
For hard wire
up to diam 1,5 mm



17-223
220 mm

for soft wire
up to diam. 3,5 mm
For hard wire
up to diam 2,5 mm

Wire Cutting Pliers



17-224
320 mm

for soft wire
up to diam. 3,0 mm
For hard wire
up to diam 3,0 mm



Cutter for cutting off
KIRSCHNER wires,
Tibia head screws,
bolts, pins, up to 3 mm diam.



DURROTIP

17-225
Cutter for cutting off
KIRSCHNER wires,
Tibia head screws,
bolts, pins, up to 6 mm diam.
470 mm

Finger Nail Instruments

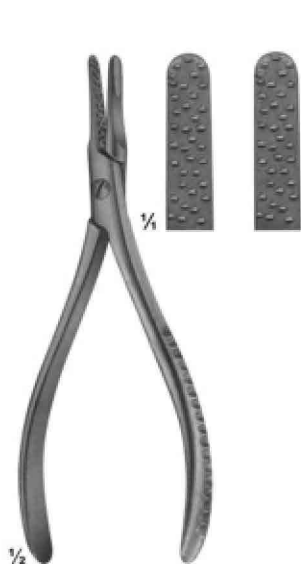

17-226
Nail extracting
forceps
135 mm



17-227
Nail extracting
forceps
145 mm

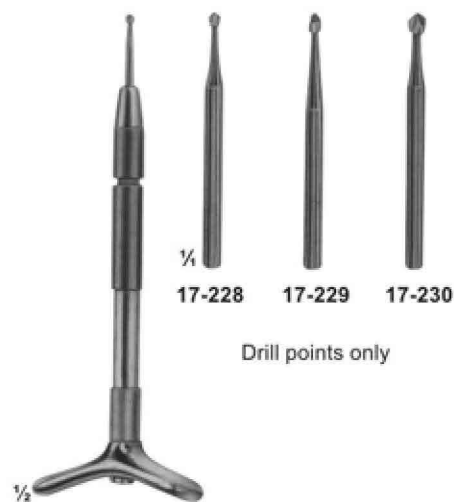

17-228
Finger nail drill
with 3 drill points

Drill points only

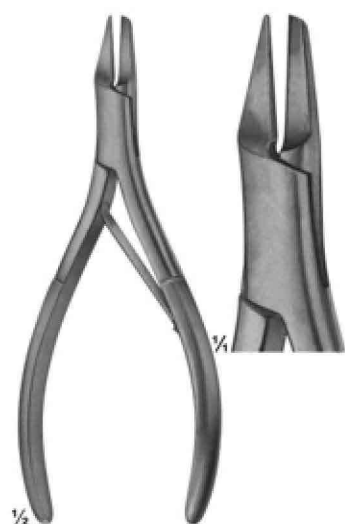

17-231
Nail splitting
forceps
135 mm

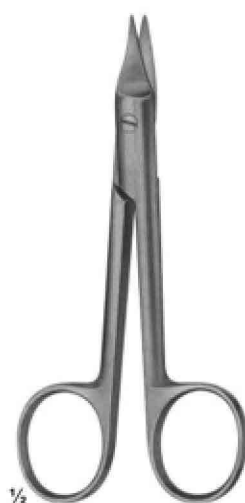

17-232
SYSTRUNK
Scissors, for splitting
finger nails
130 mm



17-233
Finger ring saw
150 mm

Spare blade
17-234

Plaster Shears



17-235
STILLE-AESFULAP
260 mm



17-236
STILLE-AESFULAP
360 mm

Plaster Spreader, Plaster Breakers



17-237
HENING
270 mm



17-238
MOD.USA
230 mm



17-239
290 mm



with removable jaws



17-240 - 17-241
WOLFF
17-240 180 mm
17-241 240 mm
plaster breakers

**Vacuum Currettes for Aspiration Lipectomy,
Suction Instruments**

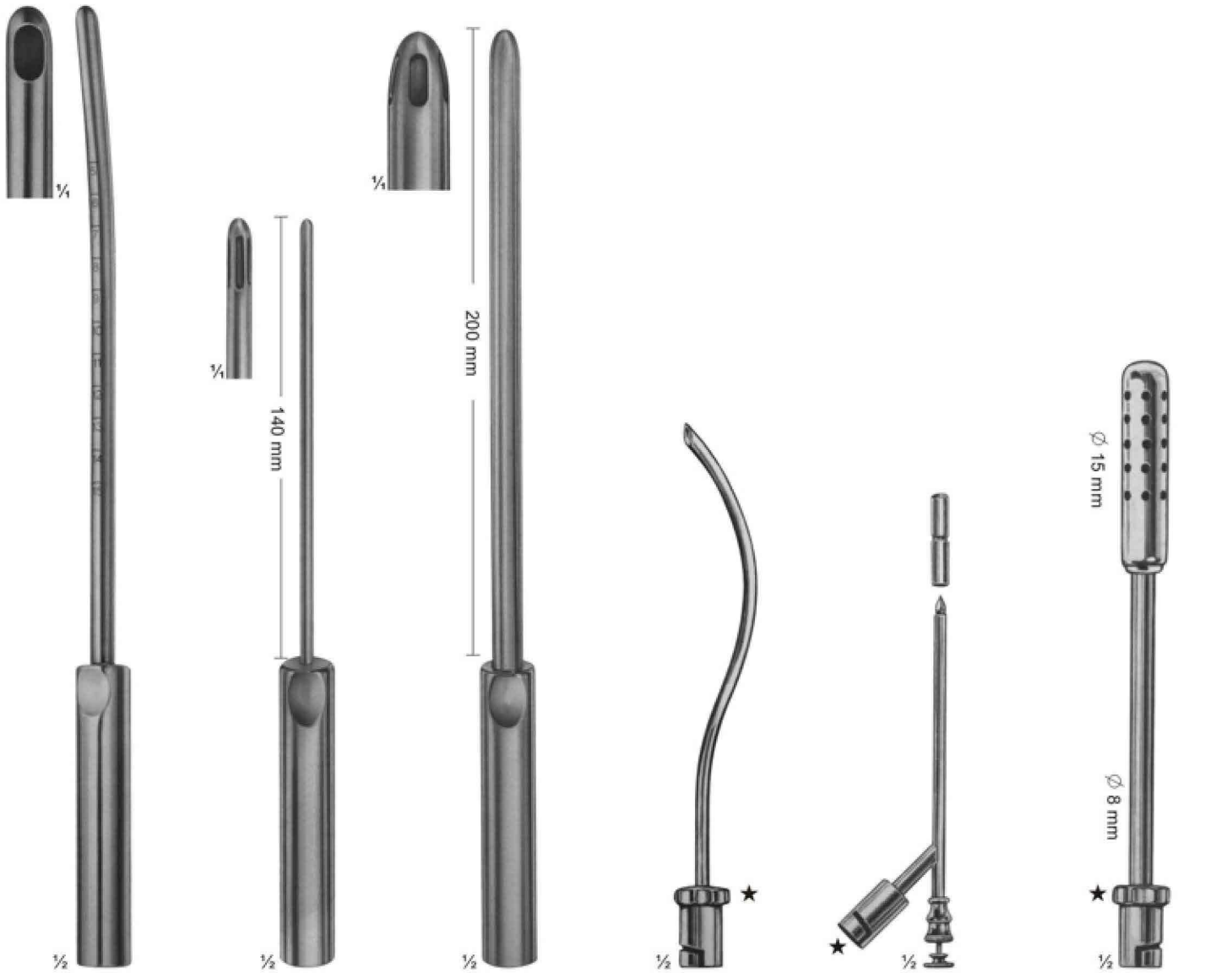

18-101 - 18-106
BIEMER
18-101 ∅ 4 mm
18-102 ∅ 6 mm
18-103 ∅ 8 mm
18-104 ∅ 10 mm
18-105 ∅ 12 mm
18-106 ∅ 14 mm
Currettes for aspiration lipectomy, graduated, slightly curved

18-107 - 18-108
BIEMER
18-107 ∅4 mm
18-108 ∅6 mm
Currettes for aspiration lipectomy, with three apertures, slightly curved malleable

18-109 - 18-111
BIEMER
18-109 ∅8 mm
18-110 ∅10 mm
18-111 ∅12 mm
Currettes for aspiration lipectomy, with three apertures, slightly curved malleable

18-112
For aspirating fluid from the excretory ducts of large glands and for keeping the operating area clear
170 mm

18-113
Trocar
For puncturing
150 mm

18-114
For clearing large quantities of fluid
190 mm

Suction Instruments

18-115 150mm
Suction handle, with vacuum regulator and finger cut-off, brass, mirror-finish chromium-plated



olive
Ø 9 mm

18-116 170mm
Suction handle, with hand regulation valve and quick-shutter, brass, mirror-finish chromium-plated



Both suction handles have bayonet fitting olive and can be used for the suction cannulae. Ø 9 mm



18-117
Trocar
For puncturing
170 mm



18-118
Hollow needle,
sharp
150 mm



18-119
double curved
For general
surgery
230 mm



18-120
For tonsillectomy,
oral and laryngeal
operations
190 mm

18-121
For tonsillectomy,
oral and laryngeal
operations
220 mm

★ With bayonet fitting to be used with suction handles (18-115 - 18-116)

Suction Instruments

18-122
WULLSTEIN
 Suction tube, conical, silver, olive
 with LUER hub
 160 mm



18-123 1,5 mm
18-124 2,0 mm
WULLSTEIN
 Suction tube, cylindrical, silver, with
 stylet olive with LUER hub
 160 mm



Usable length

YASARGIL usable length diam.			YASARGIL usable length diam.		
18-125	130 mm	1,5 mm	18-133	130 mm	2,5 mm
18-126	150 mm	1,5 mm	18-134	150 mm	2,5 mm
18-127	180 mm	1,5 mm	18-135	180 mm	2,5 mm
18-128	220 mm	1,5 mm	18-136	220 mm	2,5 mm
18-129	130 mm	2,0 mm	18-137	130 mm	3,5 mm
18-130	150 mm	2,0 mm	18-138	150 mm	3,5 mm
18-131	180 mm	2,0 mm	18-139	180 mm	3,5 mm
18-132	220 mm	2,0 mm	18-140	220 mm	3,5 mm
			18-141	180 mm	4,5 mm

olive
 Ø 6,5-9 mm
 with LUER hub

18-142 - 18-144
LANDOLT
 150 MM
 diam Ø 3 mm

18-142 8 mm / curved
18-143 11mm / curved
18-144 15mm / curved

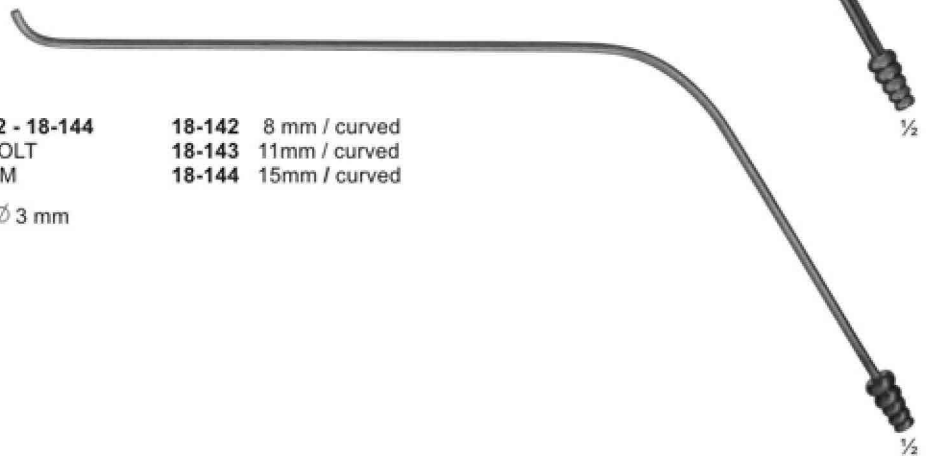

18-145 500 mm
18-146 350 mm
 with rubber tip,
 with LUER hub

18-147 2,0 mm diam
18-148 2,5 mm diam
18-149 3,0 mm diam
 with finger cut-off,
 thumb piece 90° to
 curve, with LUER hub
 250 mm



Combined Suction and Irrigation Cannulae, Coagulation Suction Cannulae



18-151
YASARGIL
LUER-LOCK cone
200 mm

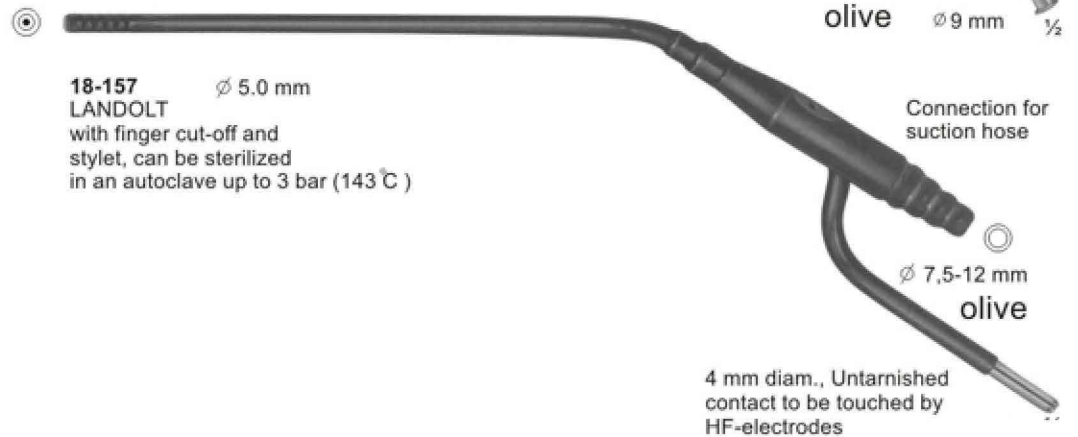
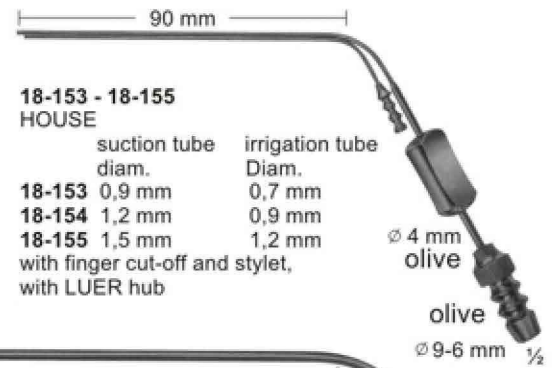
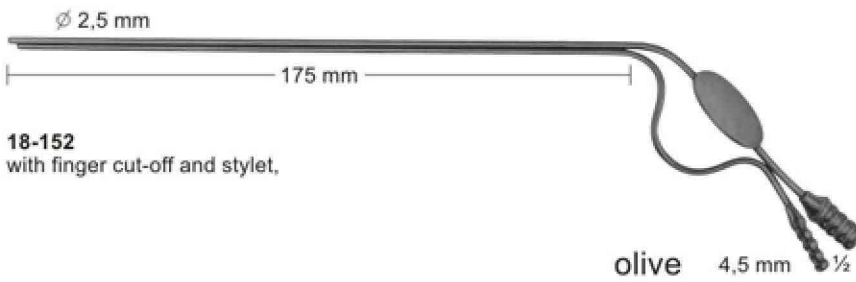

Suction Instruments

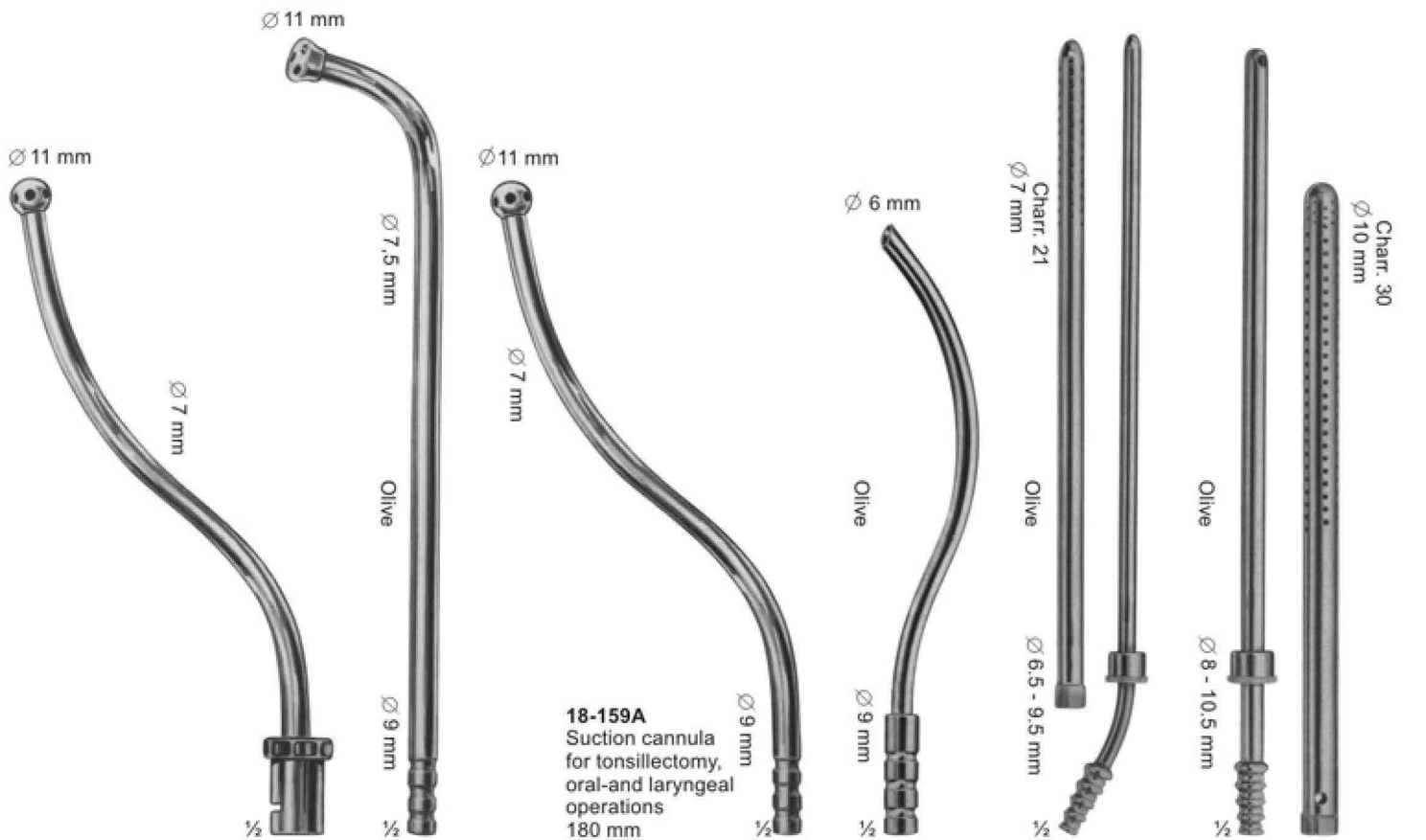

18-158
For tonsillectomy,
oral-and laryngeal
operations
180 mm

18-159
Suction cannula
for tonsillectomy,
oral-and laryngeal
operations
220 mm

18-159A
Suction cannula
for tonsillectomy,
oral-and laryngeal
operations
180 mm

18-160
S-shaped blunt cannula
for aspirating fluid from
the excretory ducts of
large glands and for
keeping the operating
area clear
170 mm

18-161
POOL
Suction cannula,
with outer tube
to be screwed of
225 mm

18-162
POOL
Suction cannula,
with outer tube
to be screwed off
225 mm

Suction Instruments

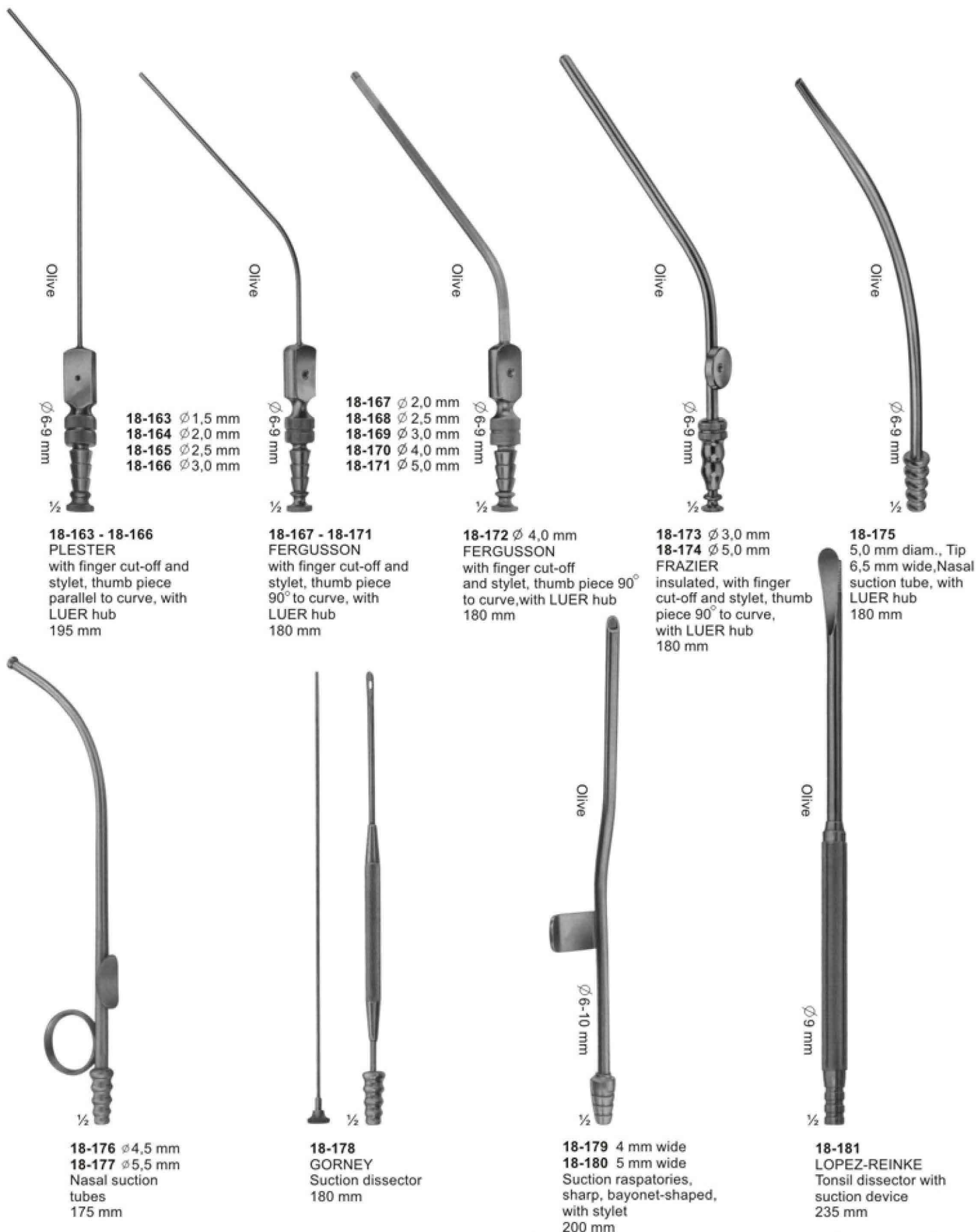

Dissection Instruments

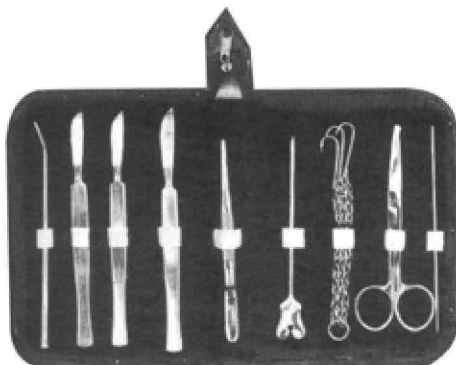

18-182

- 1- Blow pipe .
- 2- 3 PCS .scalpel.
- 3- Dissecting forcep 13 cm.
- 4- Grooved director with tounge tie 13 cm.
- 5- Triple chain hook.
- 6- Dressing scissors probe pointed 13 cm.
- 7- Probe double 13 cm.
- 8- Zipper case inside red velvet.

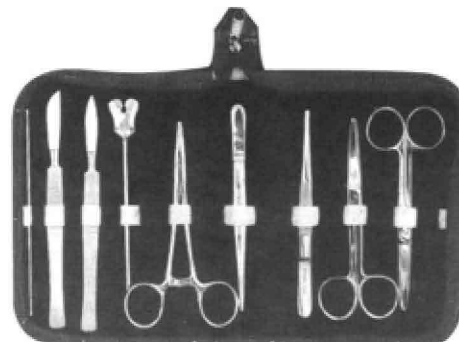

18-183

- 1- Probe Double 13 cm
- 2- 2 PCS. Scalpel S.S
- 3- Grooved Director With tongue Tie 13 cm
- 4- Mayo Hegar Needle Holder 13cm
- 5- Disscting Forcep 13 cm 1x2 Teeth
- 6- Dressing Forcep 13 CMS Serrated.
- 7- Dressing Scissor 13 cm S/B STR.
- 8- Dressing Scissor 13 cm S/B CVD.
- 9- Zipper Case Inside Red Velvet.

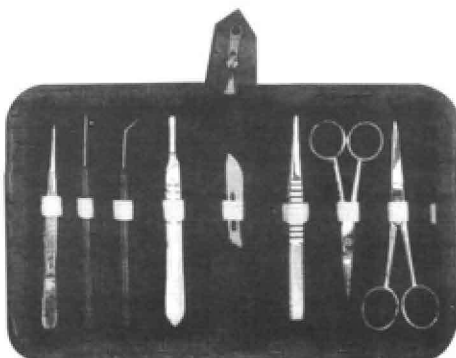

18-184

- 1- Dissecting Forcep 11.5 cm Sharp Point.
- 2- Iris Scissor
- 3- B.P Handle No. 4
- 4- Teasing Needle Sharp angular.
- 5- Blade No. 22
- 6- Thumb Forceps T.O.E 13 cm
- 7- Dissecting Scissor STR 11.5 cm
- 8- Dissecting Scissor STR 13 cm
- 9- Zipper case Inside Red Velvet

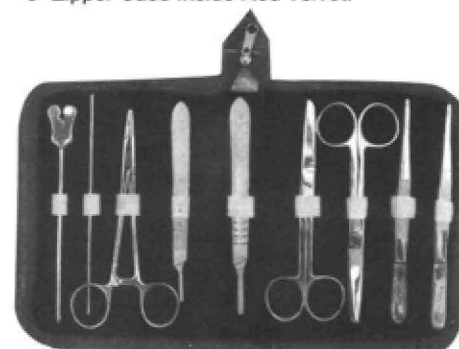

18-185

- 1- Grooved Director with Tongue Tie 14 cm
- 2- Probe Double 14cm
- 3- Mayo Hegar Needle Holder 14 cm
- 4- BP. Handle no.3
- 5- BP. Handle no.4
- 6- Dressing Scissor 14 cm S/B STR
- 7- Dressing Scissor 14 cm S/B CVD.
- 8- Dressing Forcep 1x2 Teeth 14 cm
- 9- Dressing Forcep Serrated 14 cm

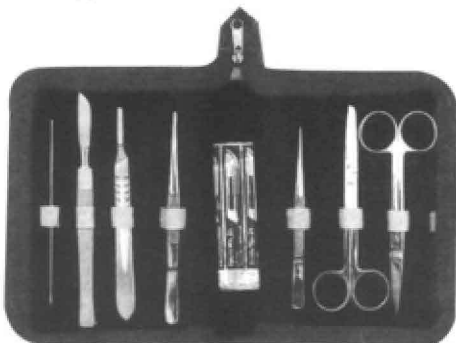

18-186

- 1- Probe double 12.5 cm
- 2- Scalpel
- 3- B.P Handle No. 4
- 4- 6 PCS Blade 2 each no. 21, 22, 23
- 5- Dissecting Forcep 12.5 cm
- 6- Dissecting Forcep 11.5 cm sharp Point
- 7- Dissecting Scissor S/B STR 13 cm
- 8- Dissecting Scissor S/S STR 13 cm

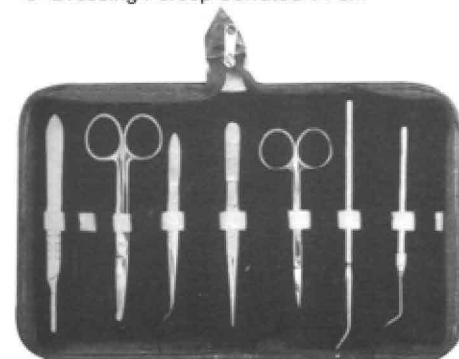

18-187

- 1- Teasing Needle with Chuck CVD.
- 2- Huber Probe
- 3- Iris Scissor
- 4- Dissecting Forcep Fine 14 cm.
- 5- Dissecting Forcep Fine CVD. 12 cm
- 6- Operating Scissor with Probe 14 cm.
- 7- B.P. Handle no. 4

Dissection Instruments



18-188

- 1- Probe with eye
- 2- Dissecting Forcep cvd fine 12 cm.
- 3- Iris Scissor
- 4- Operating Scissor S/B str 14 cm
- 5- Grooved Director and Tongue tie
- 6- Huber Probe
- 7- Triple Chain Hook
- 8- B.P Handle No. 4
- 9- B.P Handle No. 3
- 10- Teasing Needle with Chuck cvd.
- 11- Teasing Needle with Chuck str.
- 12- Dissecting Forceps Fine 14 cm.

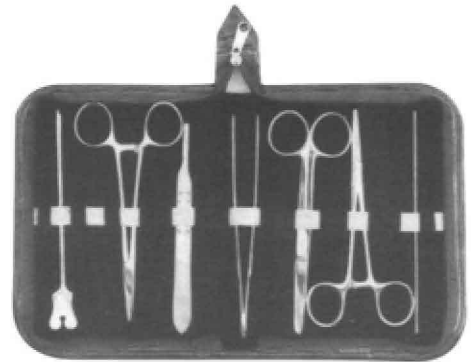

18-189

- 1- Grooved Director and Tongue tie
- 2- Mayo Hearn Needle Holder 14 cm
- 3- B.P Handle No. 4
- 4- Dissecting Forceps Thump 14 cm.
- 5- Operating Scissor S/B str 14 cm
- 6- Kelly Forcep STR 14 cm.
- 7- Probe Double end

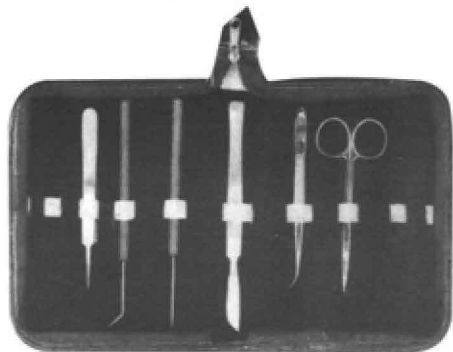

18-190

- 1- Iris Scissor STR
- 2- Dissecting Forceps CVD 12 cm.
- 3- Scalpel
- 4- Teasing Needle STR wooden handle.
- 5- Teasing Needle CVD wooden handle.
- 6- Watchmaker fine point.

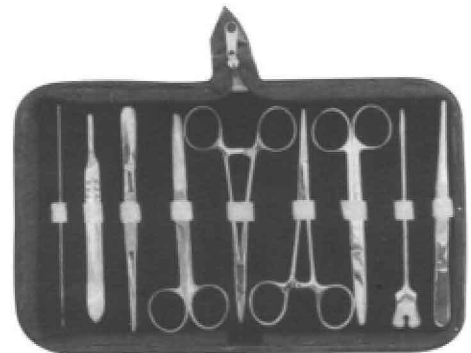

18-191

- 1- Probe Double end
- 2- B.P Handle No. 4
- 3- Dissecting Forcep 1x2 Teeth 14 cm.
- 4- Operating Scissor S/B str 14 cm
- 5- Mayo Hearn Needle Holder 14 cm
- 6- Kelly Forcep STR 14 cm.
- 7- Operating Scissor S/B CVD 14 cm
- 8- Grooved Director and Tongue tie
- 9- Dissecting Forceps Thumb 14 cm.

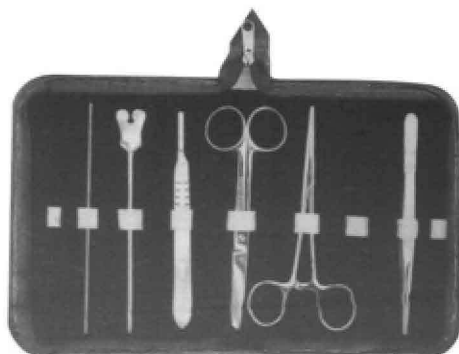

18-192

- 1- Probe double end.
- 2- Grooved director and tongue tie.
- 3- B.P handle no.4
- 4- Operating scissor STR S/b14cm.
- 5- Kelly forceps STR 14cm.
- 6- Dissecting forceps thumb 13cm.

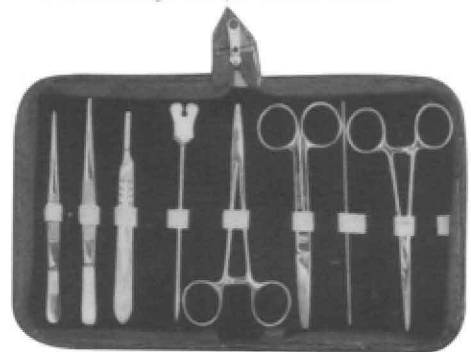

18-193

- 1- Dissecting Forceps Thumb 14 cm
- 2- Dissecting Forcep 1x2 Teeth 14 cm.
- 3- B.P Handle No. 3
- 4- Grooved Director and Tongue tie
- 5- Mayo Hearn Needle Holder 14 cm
- 6- Operating Scissor S/B str 14 cm
- 7- Probe Double end
- 8- Kelly Forcep STR 14 cm.

Dissection Instruments

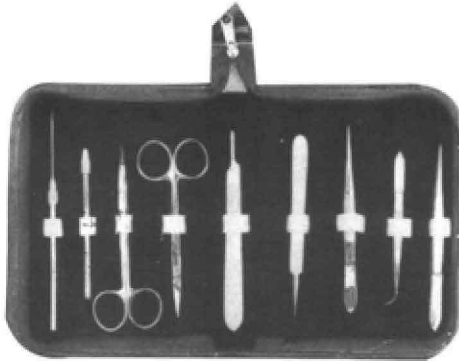

18-194

- 1- Dissecting Forcep Fine 14cm.
- 2- Dissecting Forcep Fine CVD 12cm
- 3- Dissecting Forcep with Pin 14cm.
- 4- Watchmaker Fine point
- 5- Iris scissor STR
- 6- Iris scissor CVD.
- 7- Teasing Needle holder
- 8- Teasing Needle STR.
- 9- B.P. Handle no. 3



18-195

- 1- Teasing Needle STR.
- 2- Grooved Director and Tongue Tie.
- 3- Teasing Needle CVD.
- 4- Dissecting Forcep with Pin 12 cm Fine
- 5- Operating Scissor S/B STR 14 cm
- 6- Triple Chain Hook
- 7- Probe with eye
- 8- Probe Double end
- 9- Probe and Hook
- 10- Dissecting Forcep Fine 14 cm
- 11- Iris Scissor
- 12- Huber Probe
- 13- B.P. Handle no.3
- 14- B.P. Handle no.4



18-196

- 1- Dissecting forcep fine STR with pin 12cm.
- 2- Iris scissor STR.
- 3- Probe with eye.
- 4- Probe and hook.
- 5- Operating scissor S/B STR 14cm
- 6- Triple chain hook.
- 7- B.P. handle no.4
- 8- Humber probe.
- 9- B.P.handle no.3
- 10- Teasing needle STR plastic handle.
- 11- Teasing needle CVD plastic handle.
- 12- Grooved director and tongue tie.
- 13- Probe double end.



18-197

- 1- Dissecting Forceps Thumb 14 cm.
- 2- Dissecting Forcep 1x2 Teeth 14 cm.
- 3- B.P Handle No. 3
- 4- Grooved Director and Tongue tie
- 5- Mayo Hearn Needle Holder 14 cm
- 6- Operating Scissor S/B str 14 cm
- 7- Probe Double end
- 7- Kelly Forcep STR 14 cm.

Hospital Wares



19-101 - 115
Schimmelbusch

	Ø x H sizes in mm
19-101	80 x 80
19-102	105 x 120
19-103	140 x 140
19-104	160 x 120
19-105	160 x 150
19-106	190 x 150
19-107	190 x 190
19-108	240 x 160
19-109	240 x 240
19-110	290 x 160
19-111	290 x 240
19-112	340 x 160
19-113	340 x 340
19-114	390 x 190
19-115	390 x 290



19-116
Box
120 x 65 x 13mm
(without Bulldog clamps,
without silicone tape)



19-117
Box with support
120 x 65 x 13 mm
(ohne Bulldogklemmen)



19-118
Box with support for
needle electrodes,
without instruments



19-119 - 121
50 x 25 x 4,5 mm
19-120
65 x 42 x 8 mm
19-121
75 x 25 x 4,5 mm



19-122
Ø 65mm x 15mm

Hospital Wares



19-123 - 131

	∅ x H
19-123	30 x 90 mm
19-124	50 x 100 mm
19-125	50 x 130 mm
19-126	50 x 175 mm
19-127	75 x 100 mm
19-128	75 x 130 mm
19-129	75 x 175 mm
19-130	100 x 175 mm
19-131	100 x 200 mm



19-141 - 142

- 19-141** Martin Sterilizing Forceps consisting of:
1 Sterilizing Forceps, curved, 25 cm, without ratchet, with lid for jar
1 jar with bottom plate (anti-tilt)
- 19-142** ditto, with 32 cm long Sterilizing Forceps



19-132 - 139

19-132	165 x 85 x 35 mm
19-133	200 x 100 x 35 mm
19-134	200 x 100 x 50 mm
19-135	230 x 130 x 50 mm
19-136	260 x 150 x 50 mm
19-137	270 x 235 x 50 mm
19-138	300 x 200 x 50 mm
19-139	325 x 275 x 50 mm



19-140
205 x 105 x 35 mm

Round Metal Boxes and Medicine Cups



19-143 - 148

	Ø x H
19-143	75 x 60 mm
19-144	75 x 75 mm
19-145	100 x 60 mm
19-146	100 x 100 mm
19-146A	125 x 80 mm
19-147	125 x 125 mm
19-148	150 x 150 mm



19-149
25 cc

19-150
50 cc



19-151
20 cc
Medicine Spoon



19-152
Ø 75 x 12 mm
Tablet Tray



19-153
Ø 90 x 90 mm
Metal Cup



19-154
Ø 75 x 80 mm
Sputum Cup



Kidney Dish



19-155 - 157

19-155	170 x 100 x 35 mm
19-156	250 x 140 x 40 mm
19-157	275 x 150 x 45 mm

Hospital Wares



19-158 - 165

	Ø x H		
19-158	40 x 19	mm	0.05L
19-159	61 x 30	mm	0.07L
19-160	80 x 40	mm	0.14L
19-161	116 x 50	mm	0.35L
19-162	128 x 55	mm	0.45L
19-163	147 x 65	mm	0.70L
19-164	167 x 75	mm	1.10L
19-165	187 x 85	mm	1.60L



19-166 - 170

19-166	116 x 35	mm	0.30L
19-167	128 x 38	mm	0.40L
19-168	147 x 40	mm	0.50L
19-169	157 x 45	mm	0.75L
19-170	187 x 45	mm	1.00L



19-171
Ø 110 x 28 mm 0.15L



19-172
100 cc 0.1L



19-173 - 176
19-173 0,25L
19-174 0,50L
19-175 1,00L
19-176 2,00L



19-177
235 x 190 x 40 mm



19-178
Ø 220 x 70 mm

Hospital Wares



19-179
 ∅ 50 x 100 mm
 Powder Pot



19-180
 ∅ 50 x 75 mm
 Methot With Lid



19-181
 ∅ 50 x 75 mm
 Methot Without Lid



19-182



19-183



19-184



19-185 - 186

19-185 ∅ 235 mm
19-186 ∅ 310 mm

Needle Cases



19-187
Sauerbruch
210 x 125 x 17 mm



19-188
Sauerbruch
210 x 125 x 17 mm



19-189
150 x 95 x 13 mm



19-190
150 x 95 x 13 mm



19-191
150 x 95 x 13 mm



19-192
150 x 95 x 13 mm



19-193
150 x 95 x 13 mm



19-194
150 x 95 x 13 mm



19-195
150 x 95 x 11 mm

Storing Cases



19-199 - 209

19-199	230 x 130 x 50 mm
19-200	260 x 150 x 50 mm
19-201	275 x 235 x 50 mm
19-202	300 x 200 x 50 mm
19-203	325 x 275 x 50 mm
19-204	420 x 175 x 50 mm
19-205	230 x 130 x 75 mm
19-206	260 x 150 x 75 mm
19-207	300 x 200 x 75 mm
19-208	325 x 275 x 75 mm
19-209	420 x 175 x 75 mm



19-196
Deponette
245 x 135 x 35mm



19-197
Deponette
245 x 135 x 50mm



19-198
Deponette
245 x 135 x 60mm

Sterilizing Baskets / Trays

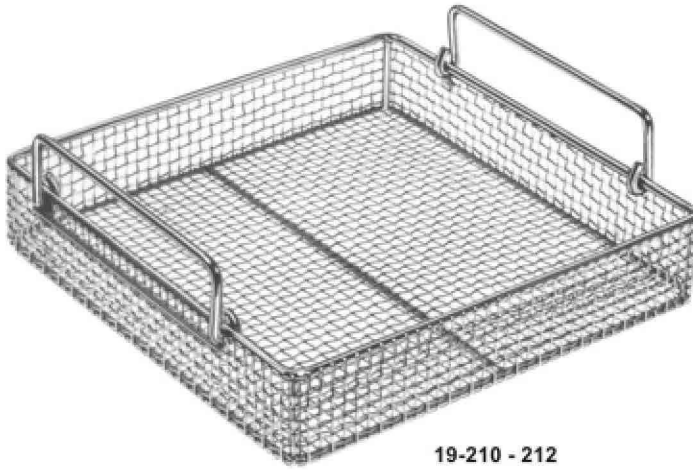

19-210 - 212

19-210	480 x 250 x 50	mm
19-211	520 x 250 x 75	mm
19-212	520 x 250 x 100	mm

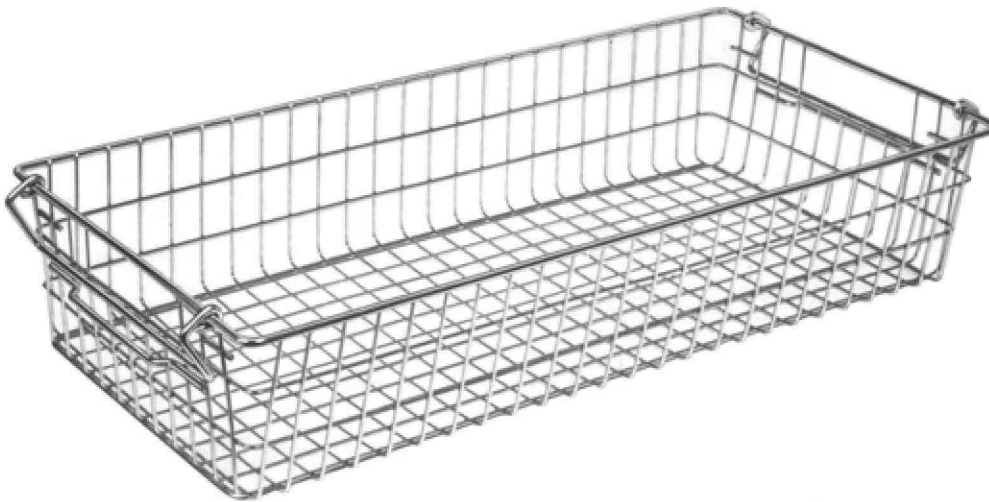

19-219
(60 x 30 x 15 cm)
Nominal dimensions

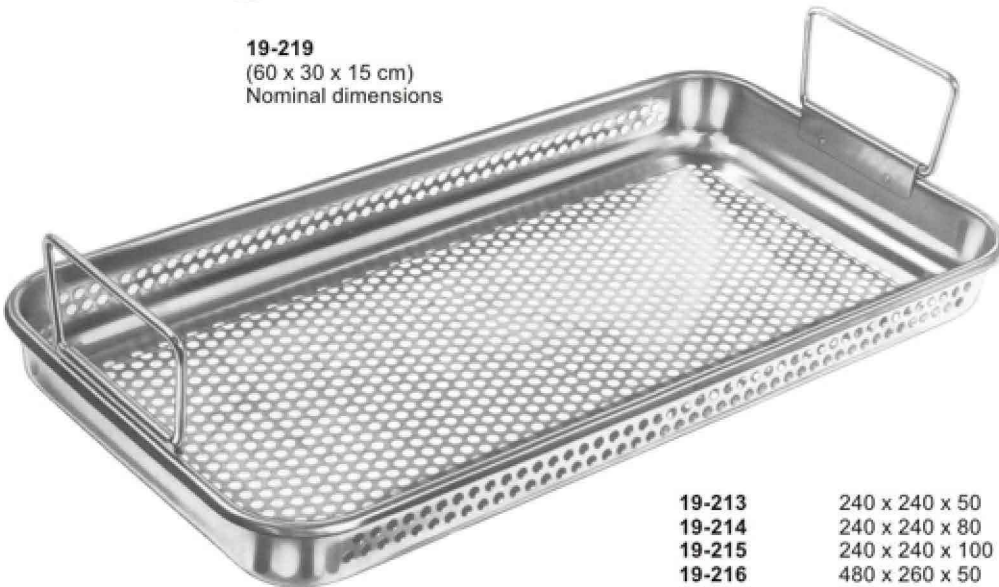

19-213 - 218

19-213	240 x 240 x 50	mm
19-214	240 x 240 x 80	mm
19-215	240 x 240 x 100	mm
19-216	480 x 260 x 50	mm
19-217	520 x 260 x 80	mm
19-218	520 x 260 x 100	mm

Scissors with Tungsten Carbide Inserts



26-101
Standard

14,5cm
16,5cm
18,5cm

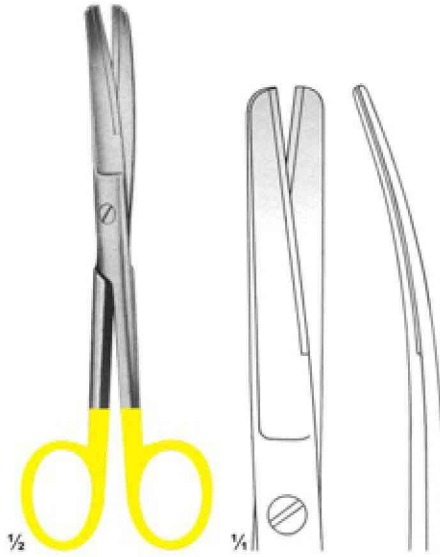

26-102
Standard

14,5cm
16,5cm
18,5cm



26-103
Standard

14,5cm
16,5cm
18,5cm

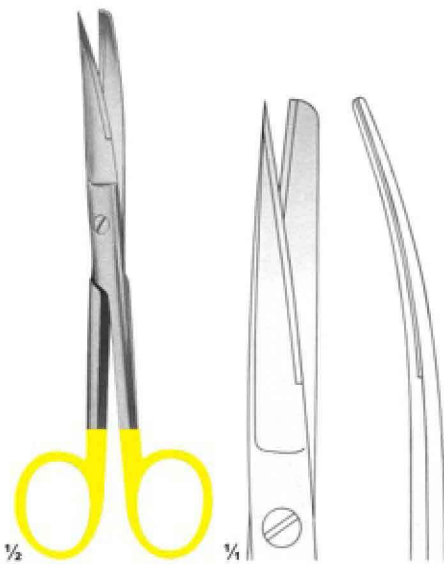

26-104
Standard

14,5cm
16,5cm
18,5cm



26-105
Standard

14,5cm
16,5cm
18,5cm



26-106
Standard

14,5cm
16,5cm
18,5cm

Scissors with Tungsten Carbide Inserts

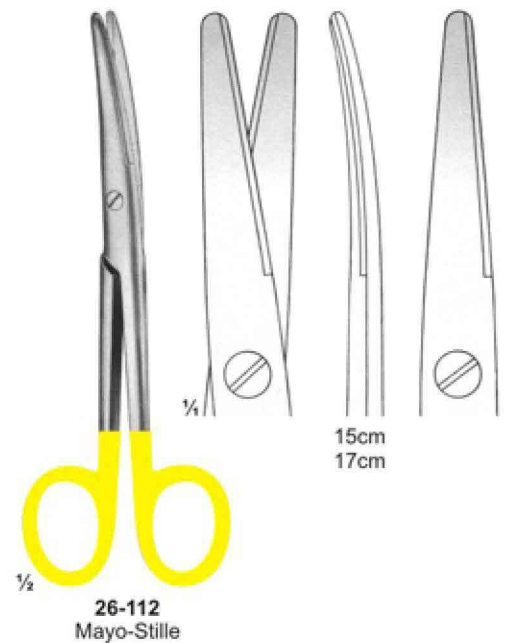
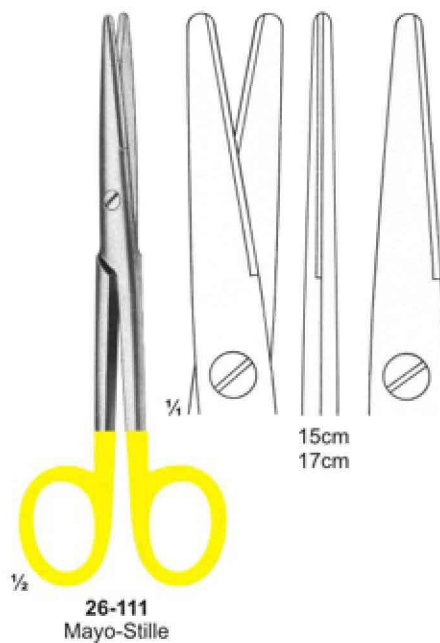
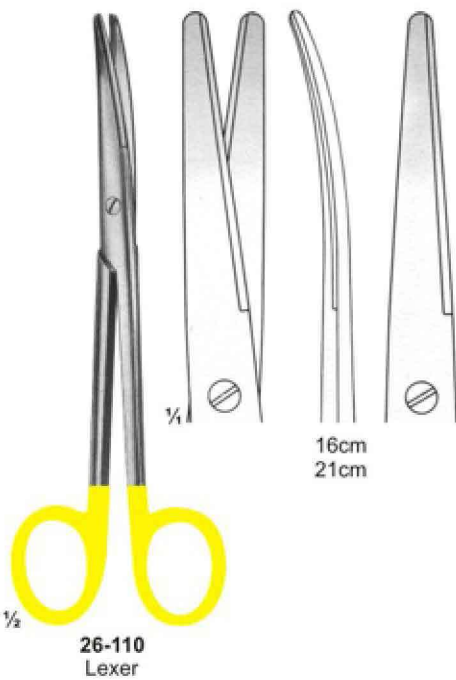
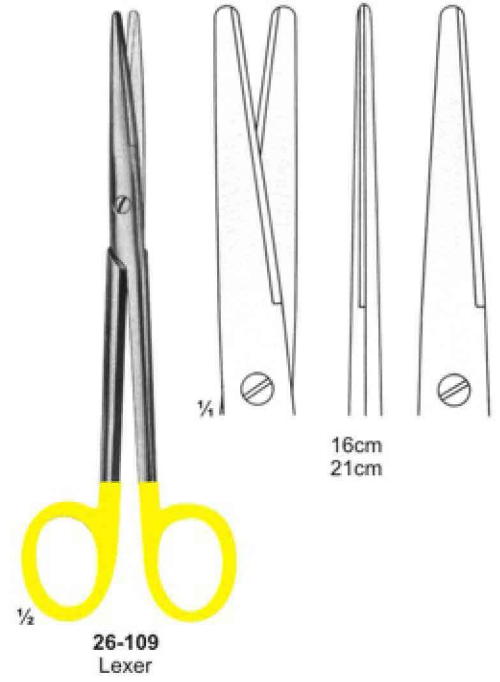
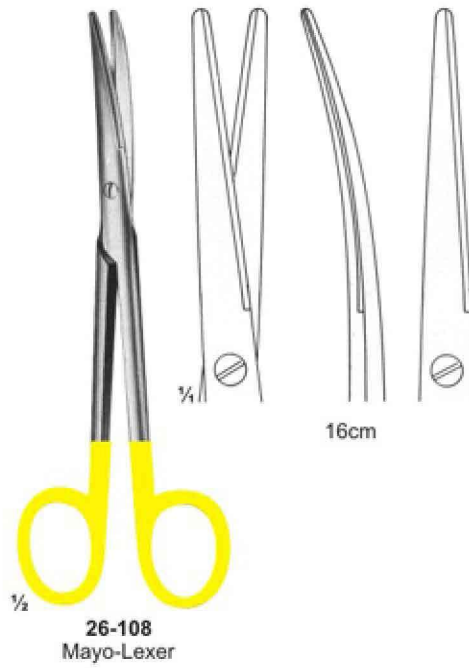
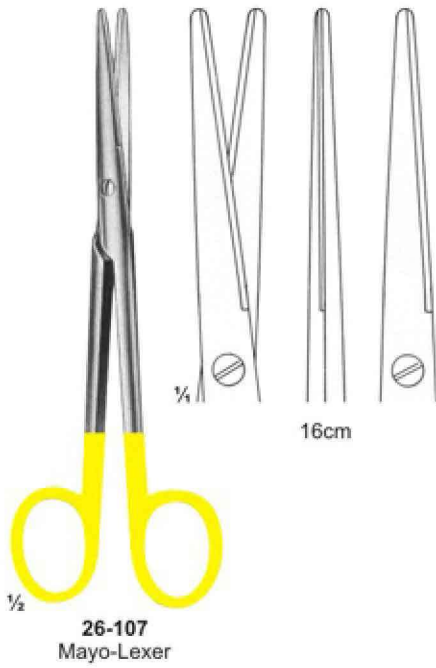

Scissors with Tungsten Carbide Inserts

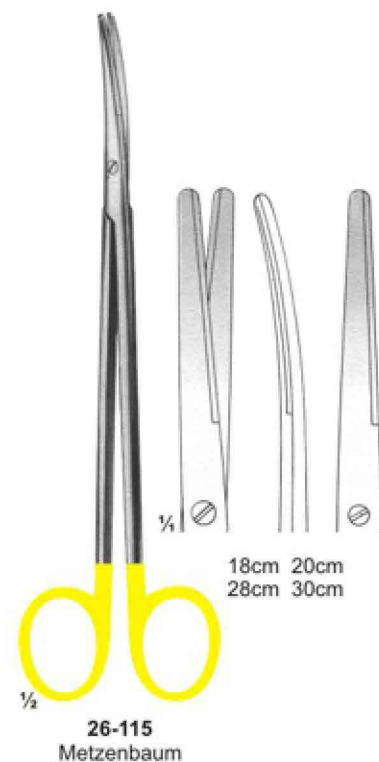
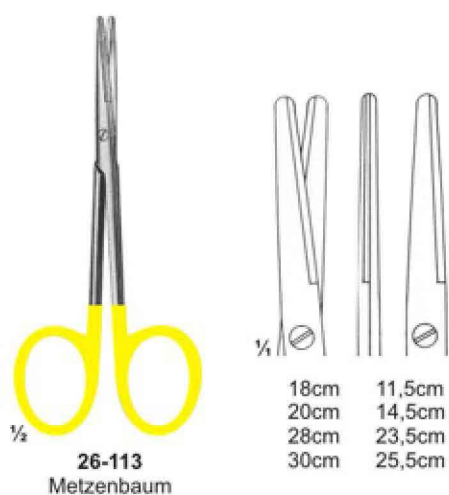

Scissors with Tungsten Carbide Inserts

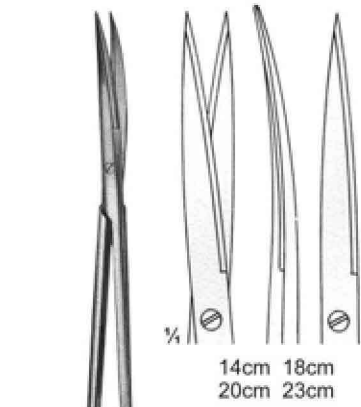

26-119
Metzenbaum-Fino

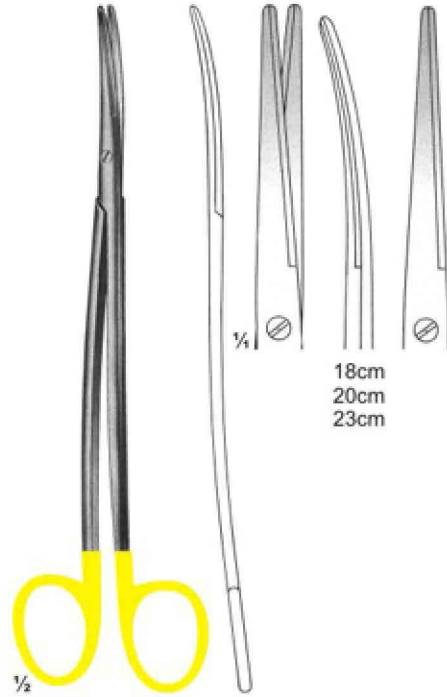

26-120
Metzenbaum-Fino

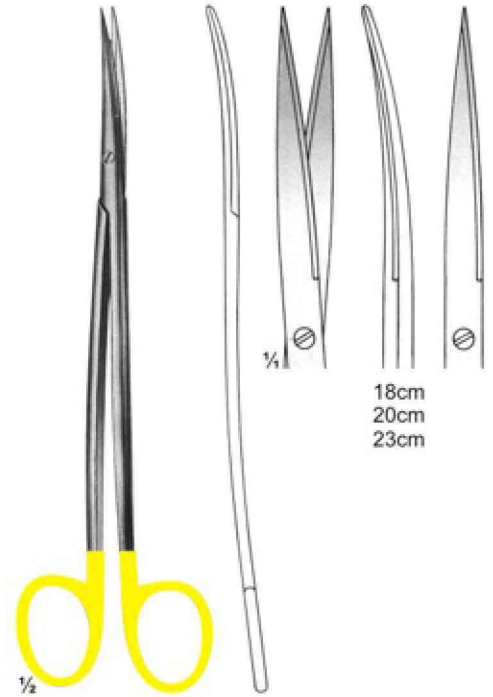

26-121
Metzenbaum-Fino

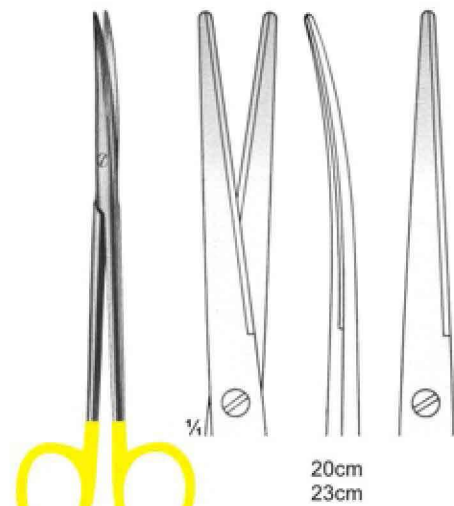

26-122
Metzenbaum

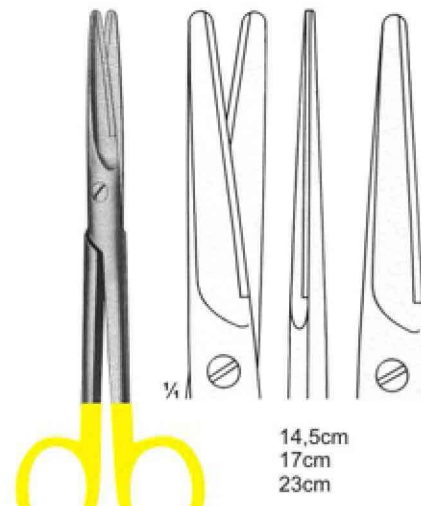

26-123
Mayo

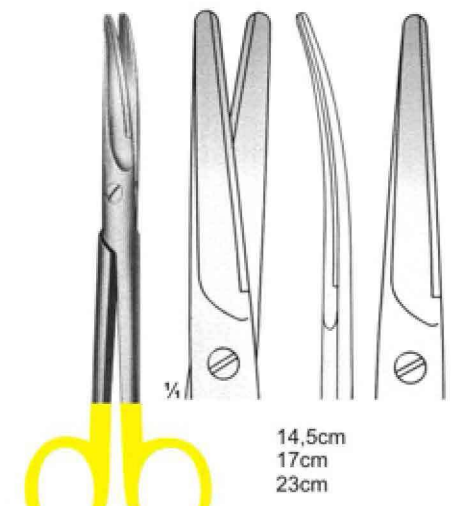

26-124
Mayo

Scissors with Tungsten Carbide Inserts

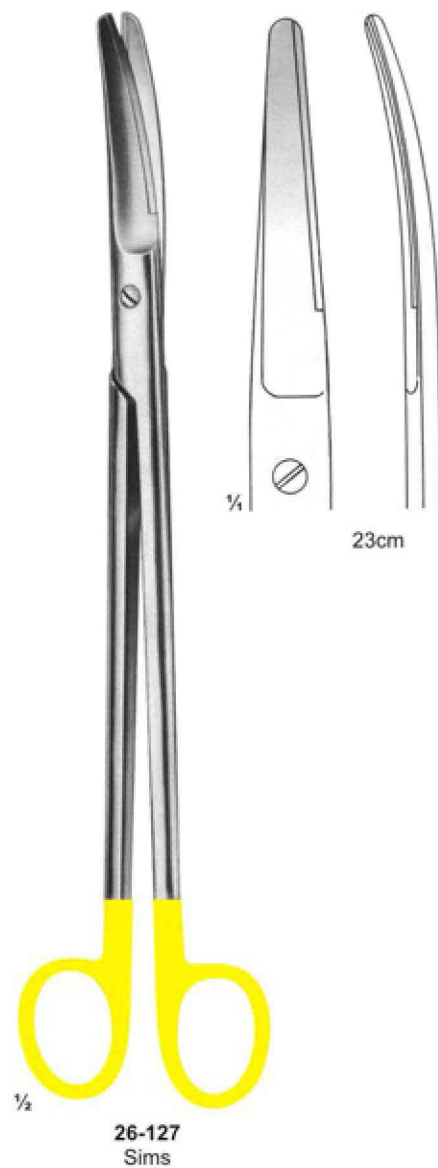
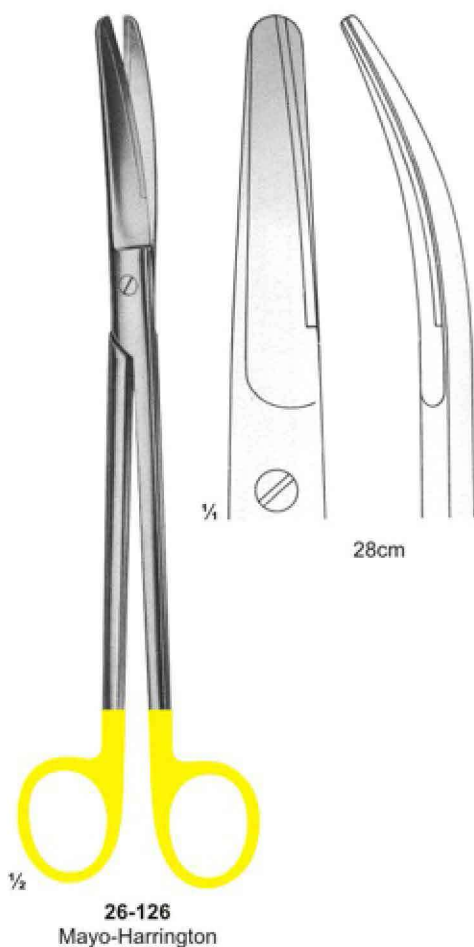
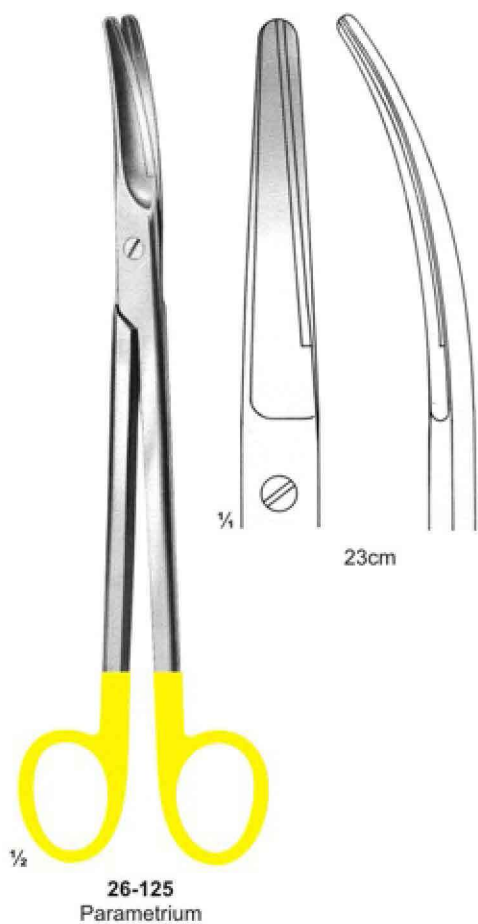

Scissors with Tungsten Carbide Inserts

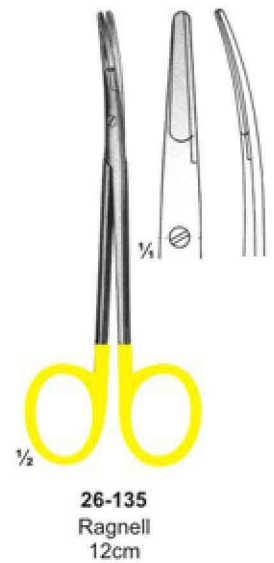
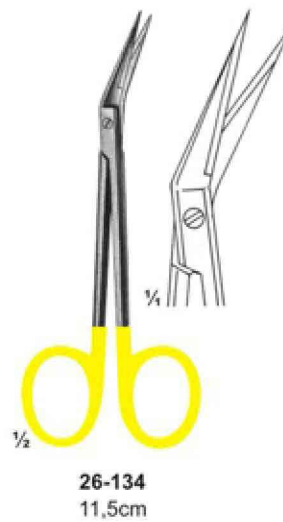
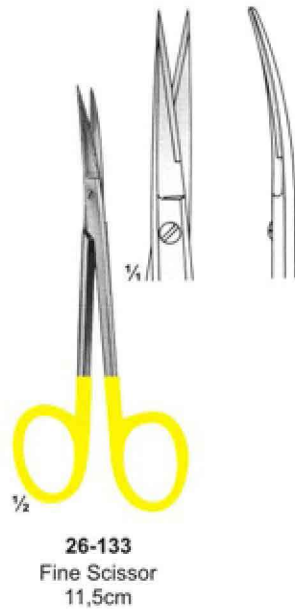
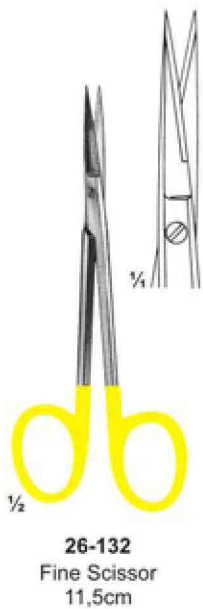
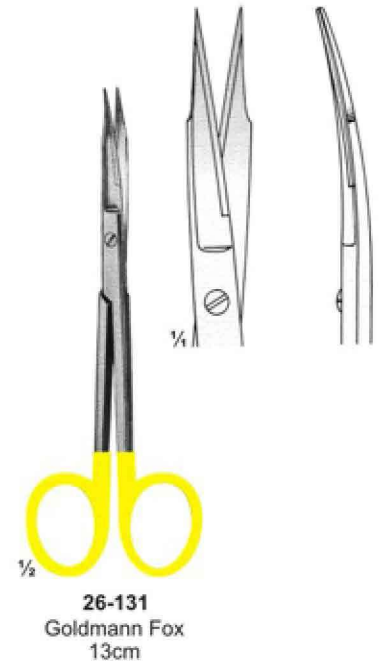
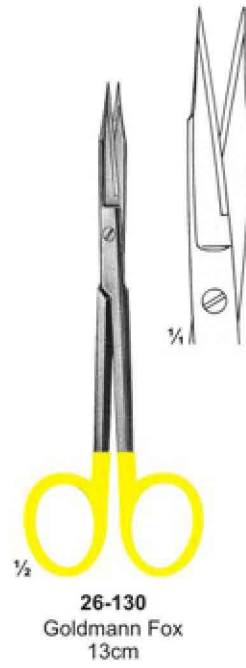

Scissors & Dissecting Forceps with Tungsten Carbide Inserts

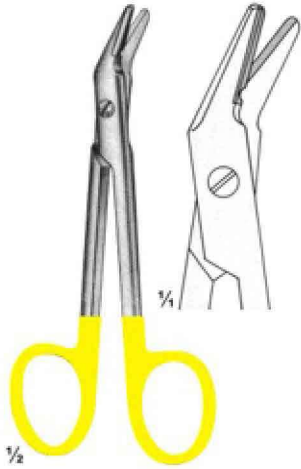

26-136
Universal
12cm



26-137
Ligature Scissors
1 Black & 1 Goldplated ring

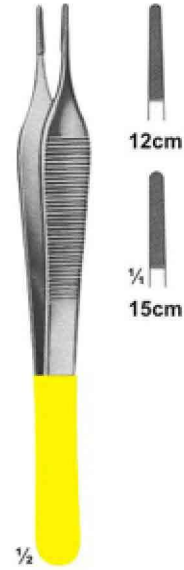

26-138
Adson



26-139
Cushing
17,5cm



26-140
Cushing
18cm



26-141
Cushing-Taylor
18cm



26-142
Dissecting Forceps
15cm



26-143
Semken
15cm

Dissecting Forceps and Needle holders with

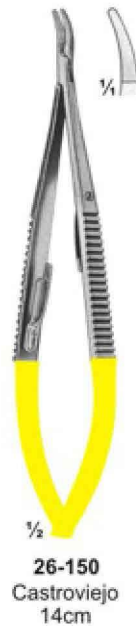
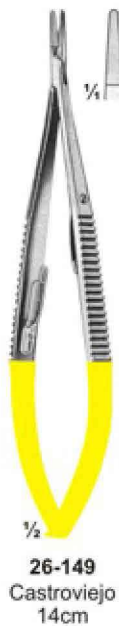
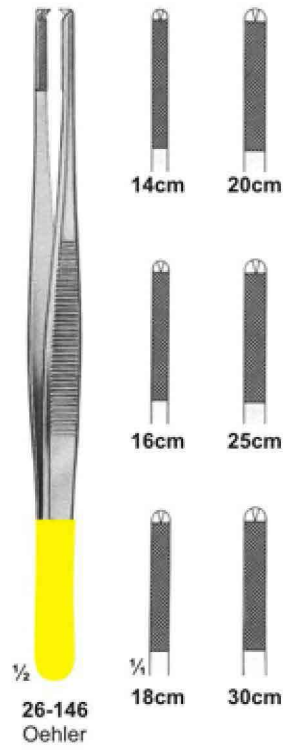
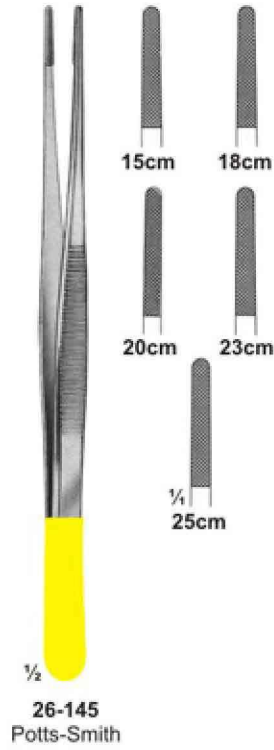
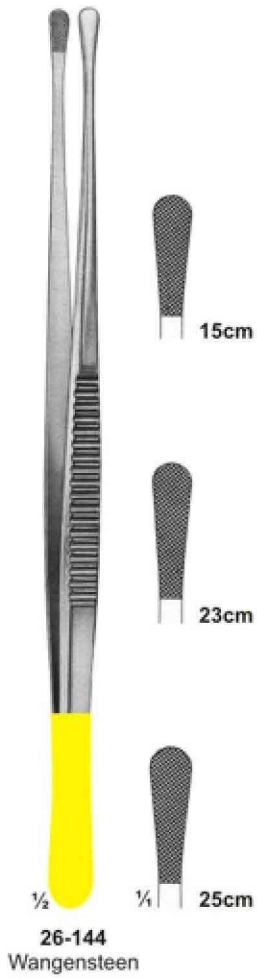

Needle holders with Tungsten Carbide Inserts



26-152
Arruga
16cm

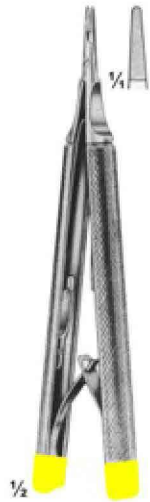

26-153
Castroviejo
13cm

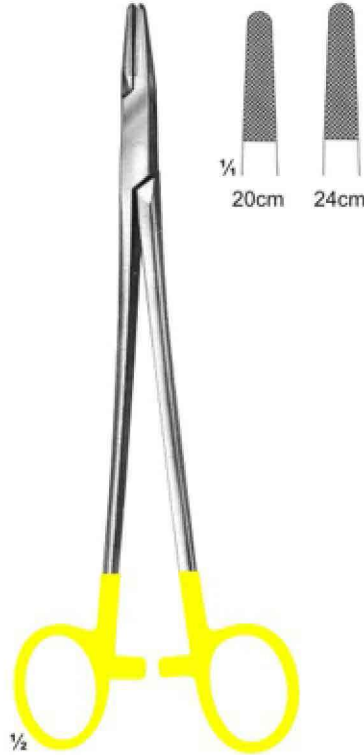

26-154
Hegar
20cm 24cm

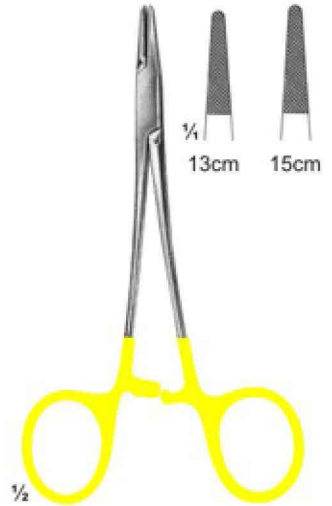

26-155
Halsey
13cm 15cm



26-156
Mayo-Hegar
16cm 18cm 20cm
24cm 26cm 30cm

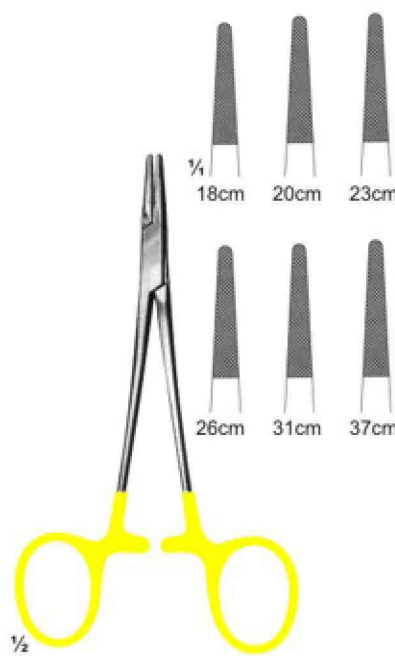

26-157
De-Bakey
18cm 20cm 23cm
26cm 31cm 37cm

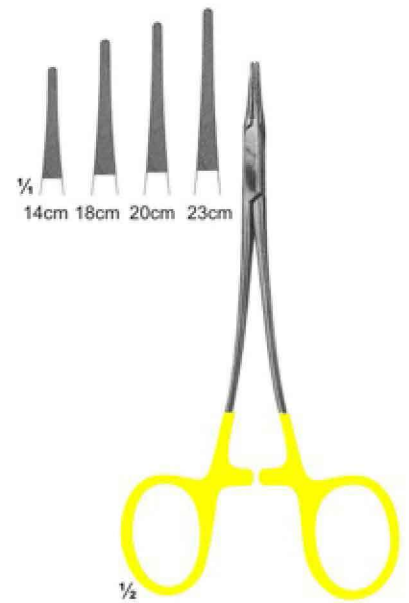

26-158
Hegar-Vascular
14cm 18cm
20cm 23cm

Needle holders with Tungsten Carbide Inserts

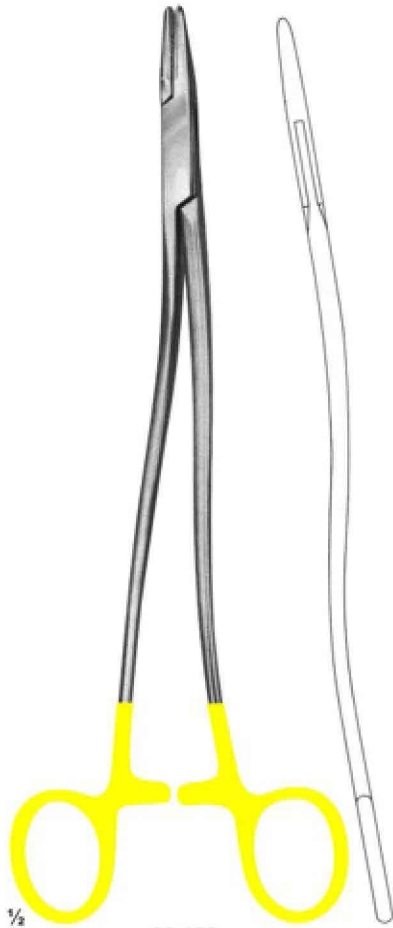

26-159
Bozemann-Wertheim
20cm 24cm 26cm



26-160
Stratte
22cm 23cm

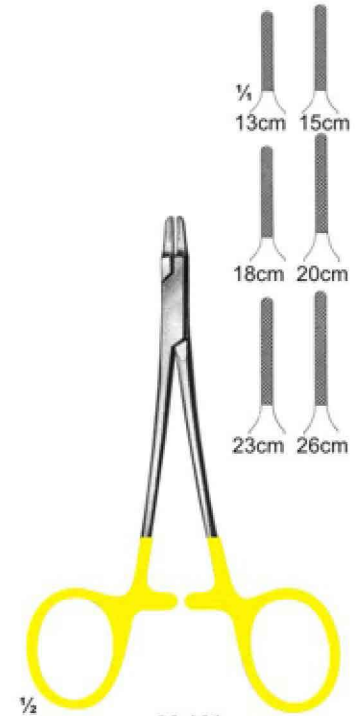

26-161
Ryder
13cm 15cm 18cm
20cm 23cm 26cm



26-162
Ryder-Vascular
13cm 15cm 18cm
20cm 23cm 26cm



26-163
Martin
15cm 17cm 20cm

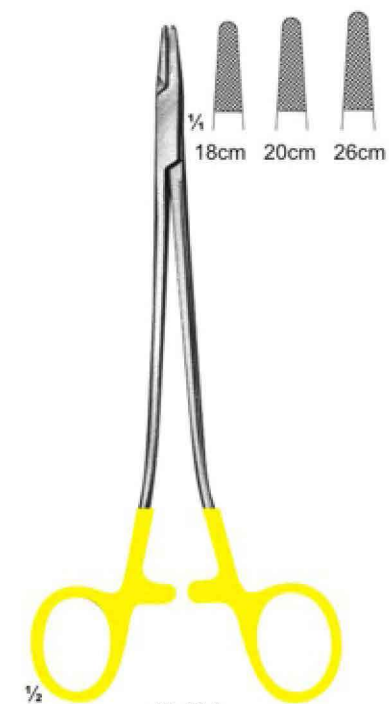

26-164
Sarot
18cm 20cm 26cm

Needle holders with Tungsten Carbide Inserts

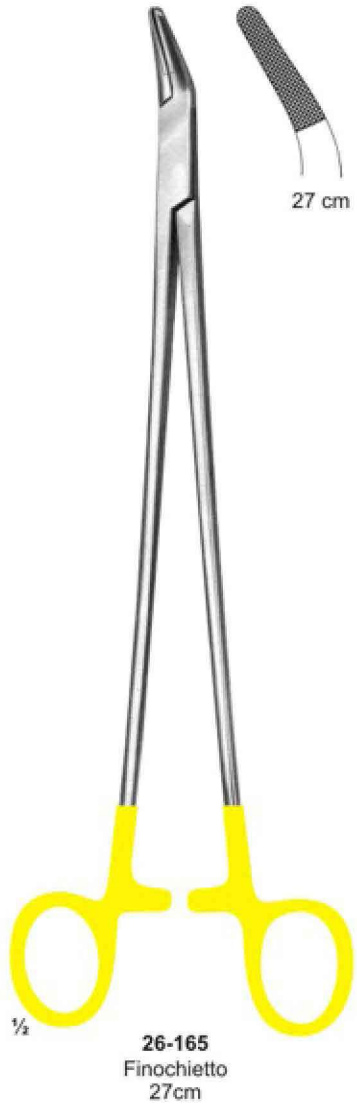

Needle holders with Tungsten Carbide Inserts



26-172
Mathieu-Ryder
17cm
20cm 24cm



26-173
Lichtenberg
20cm



26-174
Langhals
20cm 25cm



26-175
Lichtenberg
20cm 25cm



26-176
Luehty-Beck
20cm 25cm



26-177
Luehty-Beck
20cm 25cm



26-178
Langebeck
18cm
20cm 23cm

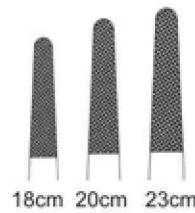

26-179
Langebeck-beck
18cm
20cm 23cm

Wire Cutting Plier With T.C. Inserts



26-180
TOENNIS
Elastic pattern for
dura-or intestinal suture
180 mm



26-181
Cutting Plier
12 cm

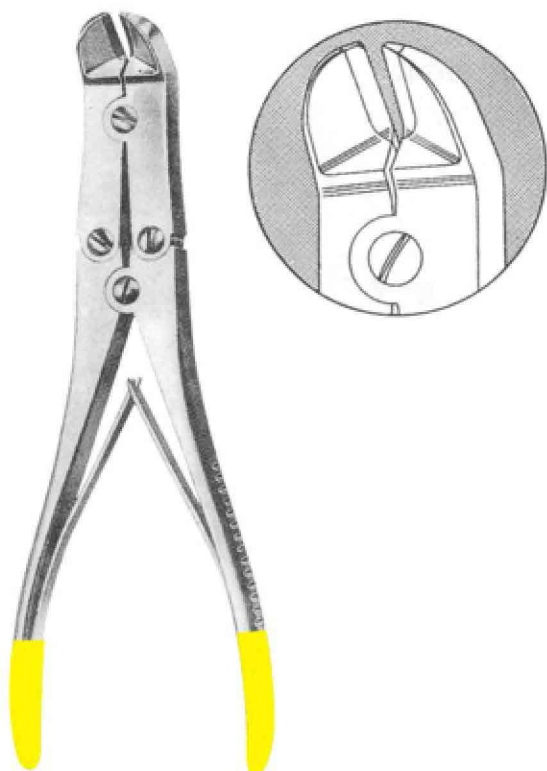

26-182
MULLAR CLAUS
22 cm



26-183
Plier
17.5 cm

Alphabetical Index

A			
ABRAHAM, tonsil knife	13	BRUNS, plaster scissor	64
ADSON, forceps	33	BRYANT, sponge forceps	43
ADSON, forceps	37	BROPHY, Tissue Forceps	38
ALLIS, artery traction forceps	47	BROWN, Tissue Forceps	39
ALLIS, intestinal grasping forceps	86	BUCHS, retractors	75
ALY, aesthesiometer	01	BUCHWALD, tongue depressor	04
AMPUTATING KNIVES	12	BUCK, neurological hammer	01
ANDREW, tongue depressor	04	BUMM, ovum forceps	230
ANESTOPHON, stethoscope	02	BUCK, Ear Curettes	110
ARRUGA, forceps	37		
ARRUGA, needle holder	61	C	
ASCH, biopsy curettes	112	CASPAR, retractor	75
AUFRIEHT, rasps	138	CASPAR, Micro scissor 115mm	16
AYRE, cone knife, 235mm	13	CASTROVIEJO, tissue forceps	37
ADSON - BROWN, Tissue Forceps	39	CASTROVIEJO, micro spring scissor	15
ADSON, Haemostatic Forceps	52	CASTROVIEJO, needle holder	61
ANGLE, Wire Cutters Cutting Scissors	151	CASTROVIEJO, eye scissor 110mm	15
		CASTROVIEJO, eye scissor 115mm	15
B		CATLIN, amputating knife 160mm	12
BABCOCK, intestinal grasping forceps	86	CALIPER, Examination & Measuring Instruments	10
BABY-ALLIS, artery traction forceps	47	CARREL, Haemostatic Forceps	51
BACKHAUS, towel clamps	48	CARROLL, Examination & Measuring Instruments	10
BACKHAUS-KOCHER, towel clamps	48	CASPAR, Rongeurs	133
BAILEY, rib spreaders	128	CASPAR, Rongeurs	134
BAKES, gall duct dilators	95	CASTROVIEJO, Examination & Measuring Instruments	10
BALFOUR, abdominal retractors	85	CHAPUT, artery traction forceps	47
BALFOUR-BABY, abdominal retractors	84	CLOWARD, lamina Spreaders	83
BANE-HARTMANN, bone rongeurs	144	CLAUS PLIER, Wire Cutting Plier With T.C. Inserts	187
BARTH, bone curettes	139	CLAUS PLIER, Wire Cutting Plier With T.C. Inserts	187
BABY-MOSQUITO, Haemostatic Forceps	51	COAKLEY, antrum trocars	100
BABY-ROUX, Retractors	73	COLLIN, intestinal grasping forceps	86
BABY-SENN-MILLER, Retractors	73	COLLIN, rib shears	126
BEEBE wire scissor	29	COLLIN, sponge and dressing forceps	44
BEER, cilia forceps	42	COLLIN, tongue forceps	05
BENGOLEA, delicate forceps	50	COLLIN, vaginal spatula	101
BERGER, biopsy forceps	115	CONE KNIFE 235mm11	13
BERLINER, percussion hammer	01	CONVERSE, fine wound retractor	69
BENDING PLIERS, Wire Holding forceps	150	COOLEY, multi purpose clamps	122
BERTILLON, Examination & Measuring Instruments	10	COTTLE, retractors	71
BIEMER, vein scissor	16	COTTLE, nasal scissor	25
BISHOP-HARMON, forceps	37	COTTLE, fine wound retractor	69
BIEMER, Suction Instruments	158	COTTLE, mallets	140
BLAKE, gall stone forceps	96	COLLIN, Examination & Measuring Instruments	10
BLUMENTHAL, bone rongeurs	144	COLLIN, Intestinal Grasping Forceps	46
BONNEY, tissue forceps	41	COLLIN, Retractors	73
BOSE, tracheal hooks	119	COLLIN-HARTMANN, Retractors	73
BOWLES, stethoscope	02	COTTLE, Forceps, Bayonet – Shaped	40
BOYS-ALLIS, artery traction forceps	47	COTTLE, Nasal Specula	91
BOZEMANN, dressing forceps	108	CRILE, Haemostatic Forceps	52
BOYNTON, Needle Holders	47	CRILE, Haemostatic Forceps	52
BRAUN, artery traction forceps	107	CRILE, Retractors	73
BRAUN, uterine probes	28	CUTTING PLIER, Wire Cutting Plier With T.C. Inserts	187
BRAUN-STADLER episiotomy scissor	31	CRAFOORD, haemostatic forceps	50
BRAUN-STADLER, bandage scissors	102	CRILE, needle holder	63
BRIESKY, vaginal specula	66	CUSCO, vaginal specula	101
BRODIE, probes	34	CUSHING, wound and vein retractor	71
BROPHY, dissecting forceps	04	CUSHING, dissecting forceps	34
BRUENINGS, tongue depressor	13	CUSHING-KOCHER, retractors	71
BRUNINGS, tonsil knife, 215mm	76	CZERNY, gall stone forceps	96
BRUNNER, retractors	126	CZERNY, retractors	72
BRUNNER, rib shears	31		

Alphabetical Index

D

DAVIDSON, scapula retractors	77
DAVIS, vascular spatulas	120
DANDY, Haemostatic Forceps	51
DE BAKEY, forceps	36
DE BAKEY, anastomosis clamps	89
DE BAKEY, anastomosis clamps	125
DE BAKEY, arteriotomy scissor	22
DE BAKEY, vana cava clamps	123
DE BAKEY, multi purpose clamps	122
DE BAKEY, retractors	82
DE BAKEY, atraumata	121
DEAN, nasal and tonsil scissor	25
DEAVER, retractors	77
DEAVER, surgical scissor (flat lock)	21
DE-BAKEY, bulldog clamps	49
DEJERINE, percussion hammer	01
DELICATE DISSECTING FORCEPS	33
DELICATE SCISSORS, blunt points	19
DELICATE SCISSORS, sharp points	18
DELICATE SCISSORS, sharp points	19
DENHARDT, mouth gag	05
DENIS-BROWENE, intestinal forceps	41
DERRA, multi purpose clamps	122
DESCHAMPS, ligature needles	65
DESJARDINS, gall duct forceps	95
DESJARDINS, gall stone forceps	96
DESJARDINS, gall stone scoops	95
DESMARRES, wound and vein retractors	71
DEMEL, Cerclage Instruments	148
DIAGNOSTIC SETS	07
DICK, vaginal clamps and compression forceps	59
DIEFFEBACH, bulldog clamps	49
DINGMANN, bone holding forceps	142
DISSECTING KNIVES	11
Dissection Instruments	164
Dissection Instruments	165
Dissection Instruments	166
DITTEL, metal bougies	80
DOYEN, abdominal retractors	79
DOYEN, intestinal clamps	87
DOYEN, ovum forceps	230
DOYEN, probes	66
DOYEN, towel clamps	48
DOYEN, vaginal specula	104
DUROGRIP, Wire Holding forceps	149
DURROTIP, Cutting Pliers	152
DURROTIP, Cutting Pliers	153
DURROTIP, Wire Cutters Cutting Scissors	151
DUVAL-COLLIN, Intestinal Grasping Forceps	46
DUPLAY, sponge and dressing forceps	43
DUVAL, intestinal forceps	41

E

EISELSBERD, needle holder	63
ELSCHING, forceps	37
ENGL.MOD, towel clamps	48
EPENDORF, biopsy forceps	115
ESMARCH, cloth and plaster scissors	31
EISELSBERG-MATHIEU, Needle Holders	64
EXTRACTION PLIERS, Wire Holding forceps	150

F

FARABEUF, Retractors	73
FEILCHENELD, splinter forceps	42
FERGUSSON, haemorrhoidal forceps	93
FERGUSSON, suction instrument	163
FERGUSSON-ACKLAND, mouth gag	05
FINOCHIETTO, forceps	58
FINOCHIETTO, rib spreader	127
FINSEN, tracheal hooks	119
FIBER OPTIC, laryngoscopes	09
FINGER NAIL DRIL, Finger Nail Instruments	155
FINGER RING SAW, Finger Nail Instruments	155
FINSTERER, Suction Instruments	161
FLAT-NOSED PLIERS, Wire Holding forceps	150
FOERSTER-BALLENGER, Tissue Grasping Forceps	45
FORCEPS, Finger Nail Instruments	155
FOREGGER, laryngoscopes	09
FOMON, nasal scissor	19
FORD-BOWLES, stethoscope	02
FOWLER, tonsil knife	13
FRANCKE, blood lancet	06
FRAZIER, fine wound retractor	69
FRAZIER, suction instruments	163
FREER, fine wound retractor	69
FREER, vascular spatulas	120
FRENZEL, tongue depressor	04
FRICKE, haemostatic forceps	56
FRITSCH, retractor	79

G

GALLAHER, rasp	126
GELPI, special retractors	82
GELPI, vaginal retractors	105
GERALD, dissecting forceps	34
GIERTZ-STILLE, rib shears	126
GILL, tissue forceps	37
GILL-HESS, tissue forceps	37
GILLIES, fine wound retractor	69
GILLIES, needle holder	63
GLOVER, bulldog clamp	49
GLUCK, rib shears	126
GOOD, tonsil scissors	25
GORNEY, suction instruments	163
GOSSET, abdominal retractors	84
GRAEFE, fine wound retractor	69
GRAVE, vaginal specula	102
GROSS, dressing forceps	43
GUEDEL-NEGUS, laryngoscope	08
GUTHRIE, fine wound retractor	69
GUYON, kidney clamps	97
GERALD, Tissue Forceps	38
GILLIES, Tissue Forceps	38
GOLDSMITH, Nasal Specula	91
GRAEFE, Tissue Forceps	39
GRAEFE, Tissue Forceps	39
GRUENWALD, Forceps, Bayonet – Shaped	40

H

HALLE, vascular spatulas	120
HALSTED-MOSQUITO, haemostatic forceps	50
HARTMANN, intestinal clamps	87

Alphabetical Index

HARVEY, plate scissors	29	KELLY, tissue grasping forceps	44
HAJEK-KOFLER, Punches	130	KERN-LANE, bone holding forceps	143
HALSTED, Haemostatic Forceps	52	KERRISON-JACOBY, punches	129
HALSTED-MOSQUITO, Haemostatic Forceps	51	KERSTING, anastomosis forceps	89
HARTMANN, Ear Polypus Forceps	112	KELLY, Haemostatic Forceps	51
HARTMANN-HALLE, Nasal Specula	91	KERRISON, Punches	130
HARTMANN-HERZFELR, Ear Polypus Forceps	112	KILLIAN, bone shear	26
HARTMANN-HOFFMAR, Ear Polypus Forceps	112	KILLIAN, rectal spatula	90
HARTMANN-WULLSTEIN, Ear Polypus Forceps	112	KILNER, fine dissecting scissors	22
HARVEY, Wire Cutters Cutting Scissors	151	KILNER, fine wound retractor	69
HEANEY, needle holder	62	KILNER, dissecting scissor	22
HEGAR, needle holder	62	KILLIAN, Nasal Specula	90
HEGAR-OLSEN, needle holder	63	KIRSCHNER, Cutting Pliers	154
HEGER, uterine dilators	106	KIRSCHNER, Wire Extension	147
HEISS, haemostatic forceps	50	KOCHER, Haemostatic Forceps	52
HEISS, dressing forceps	58	KOCHER, Haemostatic Forceps	54
HEISTER, mouth gag	05	KOCHER-OCHSNER, Haemostatic Forceps	55
HENING, plaster spreader	157	KLIMA ROSEGGER, trocars	100
HERGET, biopsy forceps	113	KOCHER, retractor	71
HERTZLER, abdominal retractors	84	KOCHER, bladder retractors	99
HERTZLER, rib spreaders	127	KOCHER, bone retractor	74
HESS, tissue forceps	37	KOCHER, retractors	75
HEYMANN-KNIGHT, scissors	25	KOLLE, blood lancet	06
HEYWOOD-SMITH, ovum forceps	109	KONIG, elevators	135
HEYWOOD-SMITH, sponge holding forceps	44	KONIG, raspatories	137
HEYWOOD-SMITH, tongue forceps	05	KONISATION SMESSER, retractors	57
HOLLOW NEEDLE, Suction Instruments	159	KRAUSE, biopsy tip	115
HOUSE, Suction Instruments	161	KRISTELLER, vaginal specula	102
HUBER, biopsy forceps	115	KRISTELLER, vaginal specula	103
HUNT, tumor & vessel forceps	32	KRONECKER, suture instruments	65
HUNTER, splinter forceps	42	KRONLEIN, haemostatic forceps	56
		KUMMEL, intestinal spatula	80
I		L	
INGE, lamina spreaders	83	LABORDE, tracheal dilators	119
INTEROSSEOUS, cartilage knife	12	LAHEY, artery traction forceps	47
IVES-FANSLER, anoscopies	92	LAHEY, gall duct forceps	94
J		LANE TRETOWAN, bone levers	136
JACKSON BURROWS, retractors	82	LANE, bone holding forceps	143
JACOBSON, bone curettes	139	LANE, bone levers	136
JACOBSON, needle holder	61	LANE, tissue forceps	41
JAEGAR, fine wound retractor	69	LANE,towel clamps	48
JAMESON, dissecting scissor	22	LANGE-HOHMANN, bone levers	136
JAMESON, needle holder	62	LANGENBACK, bone levers	135
JANSEN, bone curettes	139	LANGENBECK, with treangle handle	70
JANSEN, bone rongeurs	144	LANGENBECK, flap knife	12
JOHNS-HOPKING, bulldog clamps	49	LARYNGEAL MIRRORS	06
JOLL (FRIEDMAN), retractors	82	LAWRENCE, ligature forceps	58
JOLL, vaginal retractors	105	LANDOLT, Suction Instruments	160
JONES, towel clamps	48	LANDOLT, Suction Instruments	161
JOSEPH, bone file	138	LANGENBECK, Ear Curettes	110
JOSEPH, dura and skin retractor	69	LEBSCHKE, rib shears	126
JOSEPH, raspatories	137	LEGUEU, bladder retractors	99
JUDD-MASSON, bladder retractors	99	LEKSELL-STILLE, bone rongeurs	145
JANSEN, FORCEPS, Bayonet – Shaped	40	LERICHE, intestinal spatula	80
K		LEWIS, bone file	138
KADER, intestinal spatula	80	LISTER, bandage scissor	30
KALT, needle holder	61	LISTER, cloth scissor	30
KELLY, ovum forceps	109	LISTER, sponge forceps	43
KELLY, anoscopies	92	LISTON, bone cutting forceps	146

Alphabetical Index

LOCKHART-MUMMERY, probes	66	MULLER, dura and skin retractor	69
LOCKWOOD, Intestinal Grasping Forceps	46	MURPHY, head band	03
LUCAE, FORCEPS, Bayonet – Shaped	40	MUSEUX, tissue grasping forceps	47
LUER, Retractors	73	N	
LOCKLIN, delicate scissor	25	NASAL SCISSORS	25
LOPEZ-REINKE, suction instruments	163	NAUJOKS wire scissors	29
LOWER, gall duct forceps	94	NAIL SPLITTING, Finger Nail Instruments	155
LOWMAN, bone clamps	143	NEEDLE HOLDER, for micro surgery	48
LOWMAN-GERSTER, bone clamps	143	NEGUS, tonsil forceps	57
LOWMAN-HOGLUND, bone clamps	143	NELATON, probes	66
LUCAS, gouges	141	NELSON, lung dissecting forceps	41
LUER-KORTE, gall stone scoops	80	NISSEN, gall duct forceps	94
LURE, bone rongeurs	144	NOTO, ovum forceps	109
M		NOTO, sponge holding forceps	44
MAGILL, laryngoscope	07	NOVAK-SCHOECKAERT, biopsy curettes	111
MALTZ, rasps	138	NOYES, micro spring scissor	15
MANNERFELT, osteotomes	141	O	
MANNERFELT, retractors	70	OLIVECRONA, dura scissors	24
MARTIN, uterine probes	107	OLIVECRONA, trigeminal knife	13
MARTINI, bone curettes	139	OTOSCOPE SETS	07
MASING, retractors	71	OTOSCOPE, Diagnostic Sets	07
MASSON, needle holder	62	P	
MASSON-LUETHY, needle holder	62	PARTSCH, raspatories	137
MATHIEU, retractors	72	PARTSCH, gouges	141
MAYO, dissecting scissors	23	PARTSCH, raspatories	137
MAYO, uterine probes	107	PAYR, pylorus clamps	86
MAYO-HARRINGTON, dissecting scissors	23	PEAN, haemostatic forceps	57
MAYO-NOBLE, dissecting scissors	23	PEAN, haemostatic forceps	51
MAYO-STILLE, dissecting scissors	23	PEAN, kidney clamps	97
MARTIN, Nasal Specula	90	PEDERSON, vaginal specula	102
MATHIEU, Needle Holders	64	PEET, splinter forceps	42
MATHIEU-STILLE, Needle Holders	64	PELKMANN, uterine dressing forceps	108
MC INDOE, forceps	34	PERKINS, self retaining retractors	81
MC KENTY, raspatories	137	PIERCE, trocars	100
MEAD, mallets	140	PINARD, wooden stethoscope	02
MC INDOE, Tissue Forceps	38	PLESTER, retractors	81
MCINTOSH, laryngoscopes	09	PLESTER, suction instruments	163
MEDIUM, Dissecting Forceps	35	POOL, suction instruments	162
MICRO-HALSTED, Haemostatic Forceps	51	POTTS-SMITH, cardiovascular scissor	24
MILLIN, Needle Holders	64	PROBES	67
MICHEL, laryngeal mirrors	06	PARKER, Retractors	73
MICRO SCISSORS, laterally angled	17	PEAN, Haemostatic Forceps	52
MICRO-ADSON, forceps	33	PEAN, Haemostatic Forceps	53
MICRO-ADSON, forceps	37	PEAN, Haemostatic Forceps	54
MIDDELDORPF, retractors	75	PENNINGTON, Tissue Grasping Forceps	45
MIKULICZ, tissue forceps	57	PROVIDENCE-HOSPITAL, Haemostatic Forceps	51
MIKULICZ, intestinal spatula	80	Q	
MIKULICZ, retractors	78	QUERVAIN, bone levers	113
MILLER, laryngoscope	08	R	
MILLIN, bladder retractors	99	RABINER, neurological hammer	01
MIXTER, ligature forceps	58	RANDALL, biopsy curettes	111
MOD.USA, plaster spreader	127	RANDALL, kidney stone forceps	98
MORRIS, anastomosis clamps	89	RECAMIER, uterine scoops	116
MOYNIHAN, haemostatic forceps	57	REYNOLDS, dissecting scissors	22
MOYO-HEGAR, needle holder	62	RICHTER, vaginal retractors	105
MOD. WIEN, Nasal Specula	91	ROCHESTER-CARMALT, haemostatic forceps	57
MOLTGEN, Examination & Measuring Instruments	10	ROEDER, towel clamps	48
MULLAR, Wire Cutting Plier With T.C. Inserts	187		
MULLER LIGATURE FORCEPS	49		
MULLER VESSEL CLIPS	49		

Alphabetical Index

ROUX, retractors	72	STERBERG, Retractors	
RUDD, haemorrhoidal ligator	93	STRULLY, cardiovascular scissors (pointed)	24
RUMEL, dissecting forceps	58	SUCTION INSTRUMENTS	162
RUSS-MODELL, tissue forceps	41	SURGICAL SCISSORS, incision	21
ROHRSCHNEIDER, needle holder	61	SURGICAL SCISSORS, serrated	20
ROLLET, dura and skin retractor	69	SURGICAL SCISSORS, slender type	20
ROSER KONIG, mouth gag	05	SURGICAL SCISSORS, standard	20
RAMPLEY, Tissue Grasping Forceps	45	SURGICAL SCISSORS, standard	20
RANKIN, Haemostatic Forceps	52	SUTURING INSTRUMENT SET	68
REILL, Cutting Pliers	152	SYSTRUNK, nail splitting scissors	21
REPLACEMENT LAMP, laryngoscopes	09	SPENCER-WELLS, Haemostatic Forceps	
ROCHESTER-OCHSNER, Haemostatic Forceps	54	SYSTRUNK, Finger Nail Instruments	
ROCHESTER-PEAN, Haemostatic Forceps	53		
ROSE, Retractors	73		
ROUND PLIERS, Wire Holding forceps	150		
S		T	
SAENGER, ovum forceps	118	TAKAHASHI, rongeur	112
SAMII, tumor grasping forceps	32	TAYLOR, percussion hammer	01
SATINSKY, vena cava scissors	24	TAKAHASHI, Rongeurs	132
SAUPE, cilia forceps	42	THOREK, cardiovascular scissors	24
SCALPEL HANDLES	14	THORPE, corneal forceps	33
SCHAAF, cilia forceps	42	TIECK-HALLE, Nasal Specula	90
SCHAEDEL, towel clamps	48	TOENNIS, Wire Cutting Plier With T.C. Inserts	187
SCHEINMANN, biopsy forceps	115	TOWNLEY, Examination & Measuring Instruments	10
SCHIMMELBUSCH, ether mask	05	TOBOLD, tongue depressors	04
SCHMID, vascular spatulas	120	TOENNIS ADSON, dissecting scissors	22
SCHOEMAKER-LOTH, needle holder	63	TOENNIS, dissecting scissors	22
SCHOENBORN, retractors	71	TOENNIS, fine wound retractor	69
SCHRODER, uterine scoops	116	TOENNIS, vascular spatulas	120
SCHUMACHER, rib shears	126	TOENNIS, needle holder	63
SCHUMACHER, umbilical scissors	28	TRELAT, raspatories	137
SCHUMASHER, biopsy forceps	114	TRIGEMINAL KNIFE	13
SCOVILLE-RICHTER, retractors	67	TROCARS	100
SEGOND, myomatome	13	TROEMNER, percussion hammer	01
SEIDL, vaginal specula	102	TROUSSEAU, tracheal dilators	119
SEIDL-DBP, biopsy forceps	114	TROCAR, Suction Instruments	159
SELLORS, rib spreaders	128	TROELTSCH, FORCEPS, Bayonet – Shaped	40
SEMKEN, dissecting forceps	34	TUFFIER, rib spreaders	127
SEMKEN, tissue forceps	37	TUTTLE, lung dissecting forceps	41
SENN-MILLER, Retractors	73		
SEUTIN, plaster scissor	31	U	
SHAPLEIGH, Ear Curettes	110	UMBILICAL CORD SCISSORS	28
SIMON, uterine scoops	116	UNIVERSAL BANDAGE SCISSORS	30
SIMPLEX, tongue depressor	04	UNIVERSAL TROCARS	100
SIMPSON, uterine probes	107	US-ARMY, retractors	72
SIMPSON-BRAUN, obstetrics forceps	117		
SIMS, gynaecology scissors	27	V	
SIMS, vaginal specula	102	VANNAS, micro spring scissors	15
SIMS, rectal specula	90	VERNIER, Examination & Measuring Instruments	10
SIMS, uterine probes	107	WISE GRIP, Wire Holding forceps	150
SMOOTH JAWS FORCEPS	34	VOLKMANN, bone curettes	139
ST.MARTIN, tissue forceps	37	VOLKMANN, bone retractors	74
STEMBERG, tongue depressor	04		
STIEGLITZ, splinter forceps	42		
STILLE, bone rongeurs	145		
STILLE-AESCULAP, plaster shears	156		
STILLE-RUSKIN, bone rongeurs	145		
STRACK, wire scissor	29		
STRASSBURGER Tissue forceps	41		
STANDARD, Dissecting Forceps	35		
STANDARD, Tissue Forceps	39		

Alphabetical Index

W

WANGENSTEEN, needle holder	62
WARTENMERG, pinwheel	01
WAGNER, Rongeurs	134
WAUGH, Tissue Forceps	38
WEBER, anastomosis clamps	124
WECKER, eye scissors	15
WEIL-BLAKESLEY, rongeurs	112
WEITLANER, self retaining retractors	81
WERTHEIM, gynaecology scissors	27
WERTHEIM, clamps and forceps	59
WERTHEIM-CULLEN, vaginal clamps	60
WIEDER, tongue depressor	04
WEIL-BLAKESLEY, Rongeurs	132
WILLIGER, bone curettes	139
WILLIGER, elevators	135
WILLIGER, raspatories	137
WINTER, ovum forceps	118
WILDE, Forceps, Bayonet – Shaped	40
WOLFF, plaster breakers	157
WULLSTEIN, retractors	81
WULLSTEIN, Suction Instruments	160

Y

YASARGIL, needle holder	61
YASARGIL, tumor grasping forceps	32
YASARGIL-SAMII, tumor grasping forceps	32
YASARGIL, Suction Instruments	160
YASARGIL, Suction Instruments	161
YASRGIL, micro scissors	17
YEOMAN, biopsy forceps	113
YOUNG, tongue forceps	05
YOUNG– HRYNTSCHAK, Needle Holders	64
YOUNG-MILLIN, Needle Holders	64

Z

ZENKER, ligature	58
ZENKER, retractors	77
ZIEGLER, head band	03
ZIEGLER, head mirror	03

Surgintr[®]

Manufacturers & Exporters
of Quality Surgical Tools

SURGINTR MFG. CO.
Mohallah Chao Bhopalwala
Tehsil Sambrial,
District Sialkot 51030 Pakistan

Customer Service Contacts

Tel: +923056515151

E-mail: surgintr@gmail.com

www.surgintr.com